

Actividades para mejorar motricidad fina

Sigue los huevos para unir la gallina y el pollito

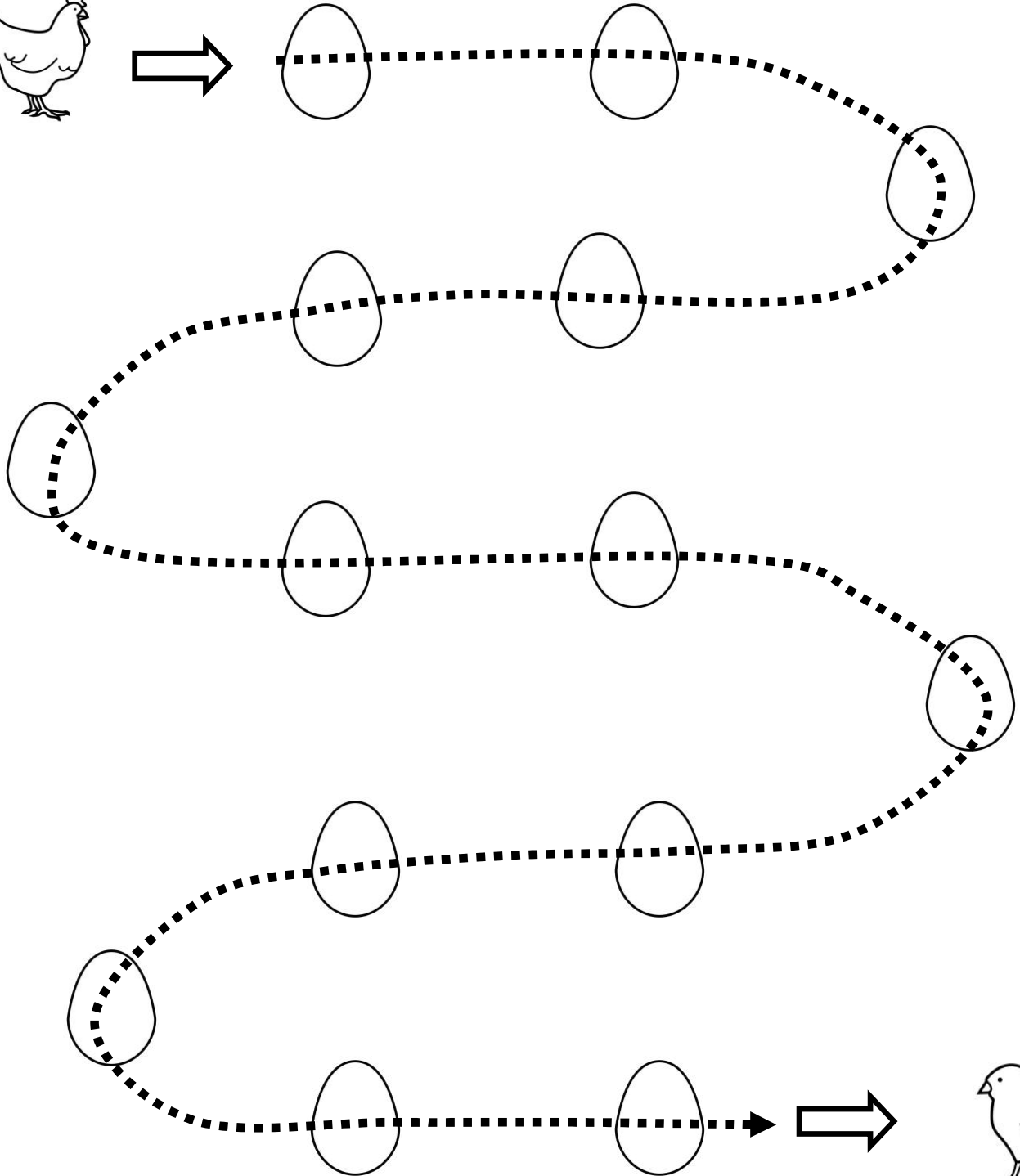
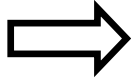
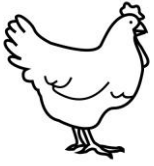

Actividades para mejorar motricidad fina

Sigue los huevos para unir la gallina y el pollito

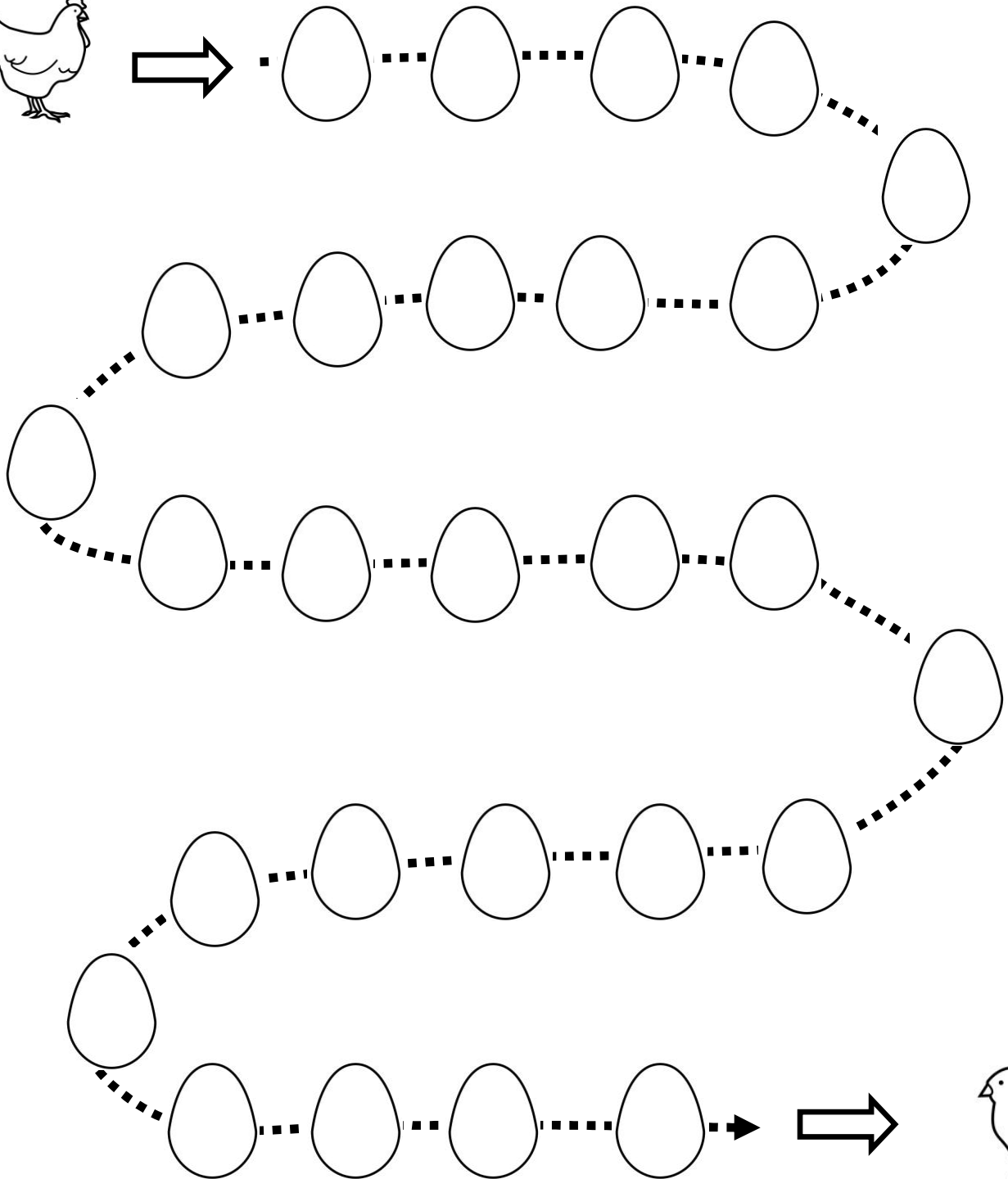

Actividades para mejorar motricidad fina

Sigue los huevos para unir la gallina y el pollito

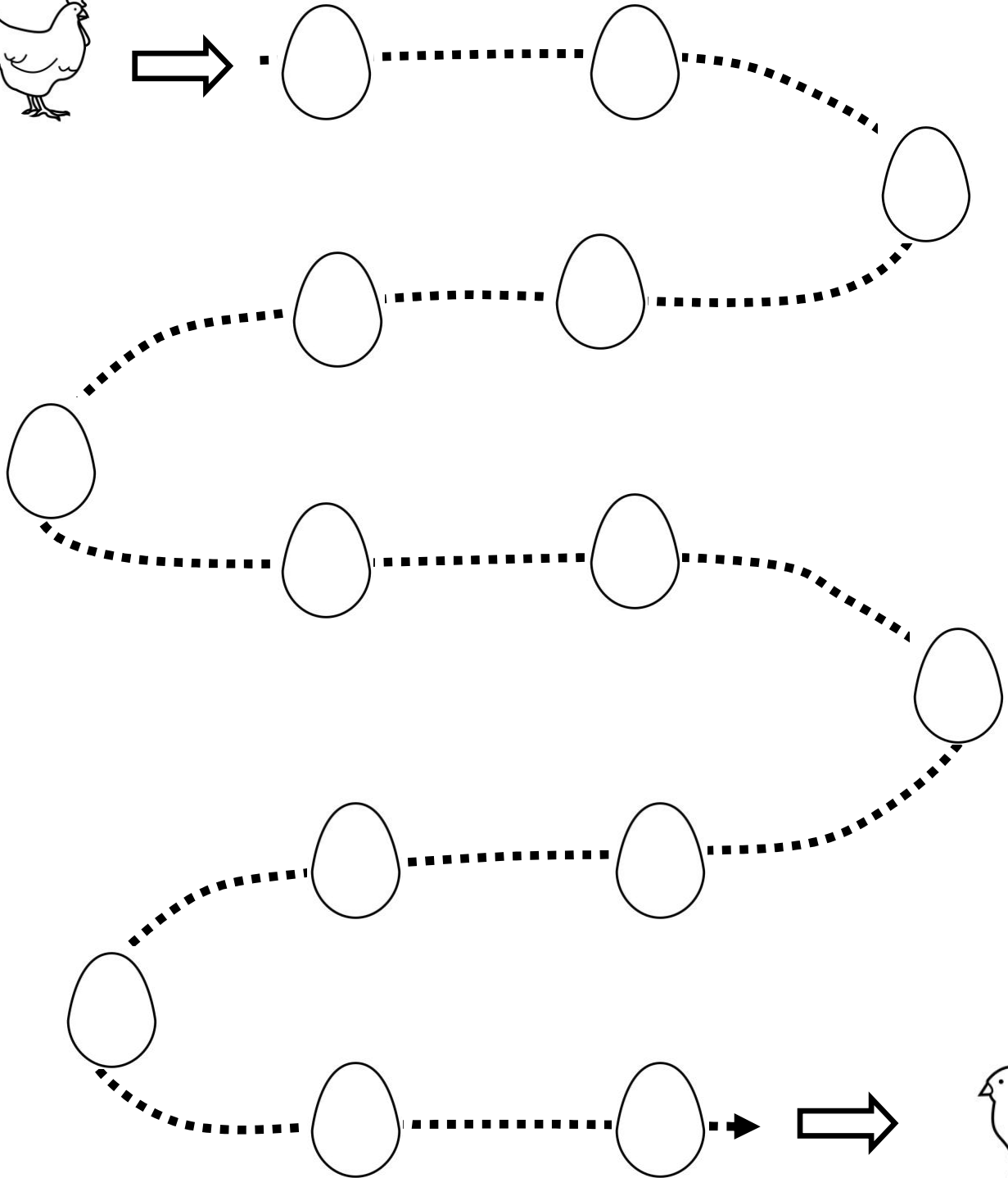
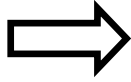
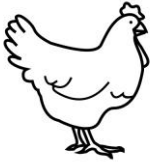

Actividades para mejorar motricidad fina

Sigue los huevos para unir la gallina y el pollito

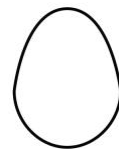
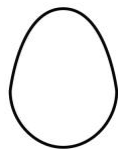
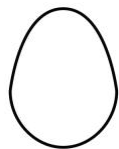
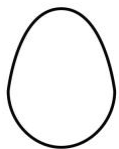
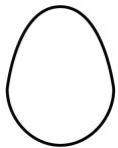
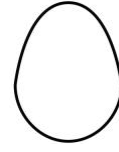
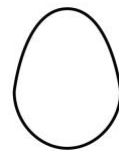
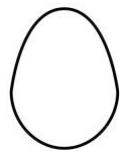
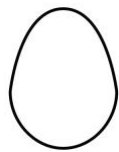
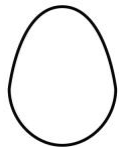
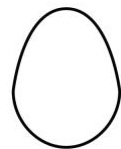
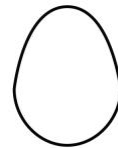
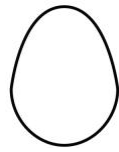
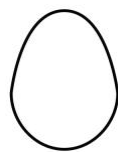
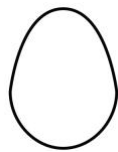
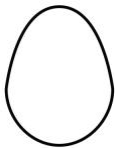
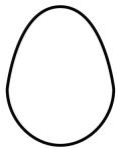
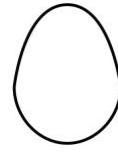
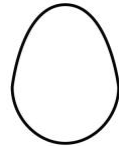
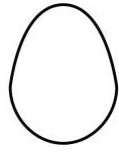
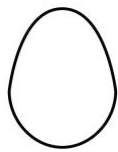
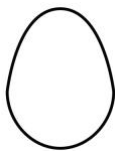
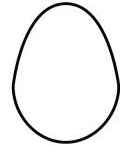
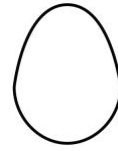
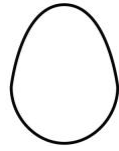
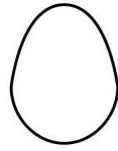
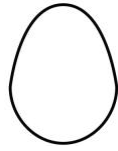
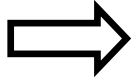
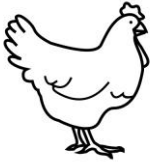

Actividades para mejorar motricidad fina

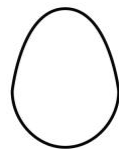
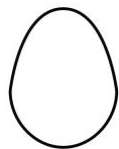
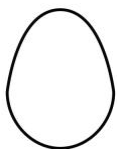
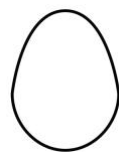
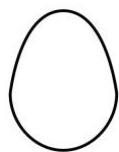
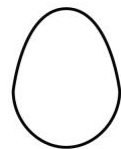
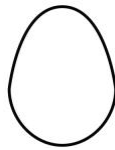
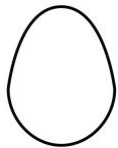
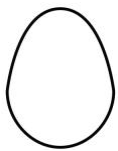
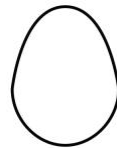
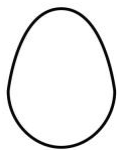
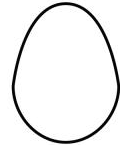
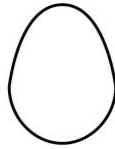
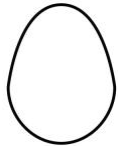
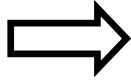
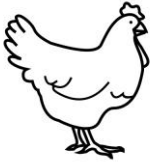

Sigue los huevos para unir la gallina y el pollito

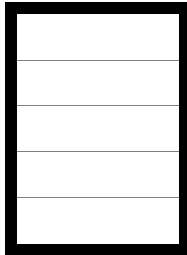

Grafomotricidad formas y cenefas

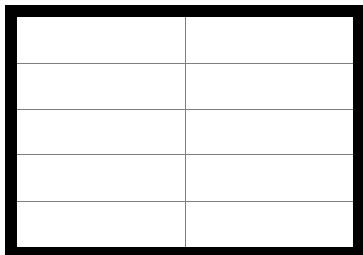

Grafomotricidad formas y cenefas



Grafomotricidad formas y cenefas

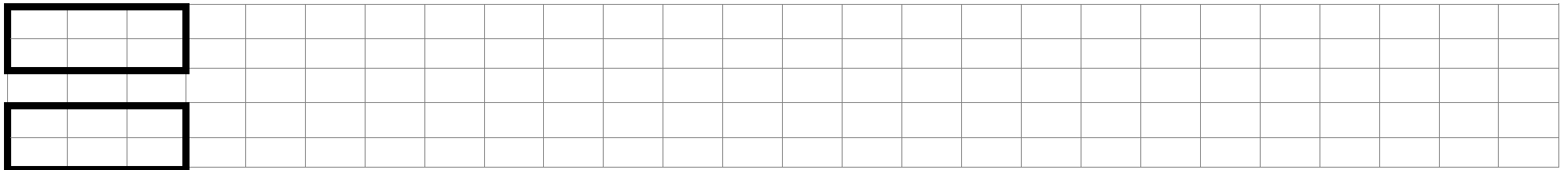
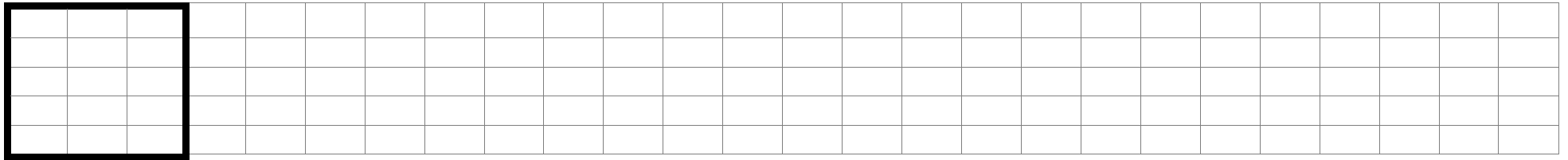
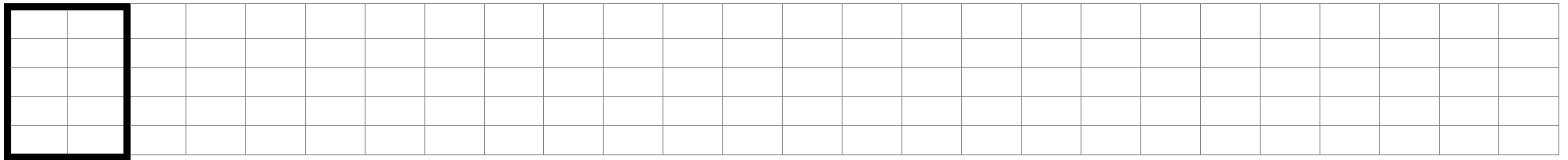
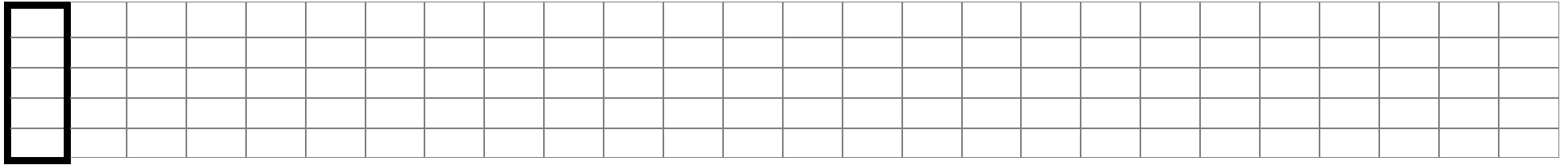

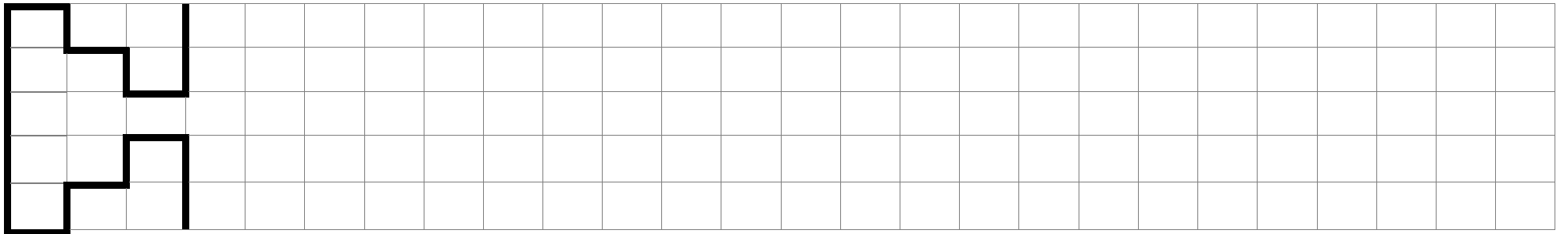
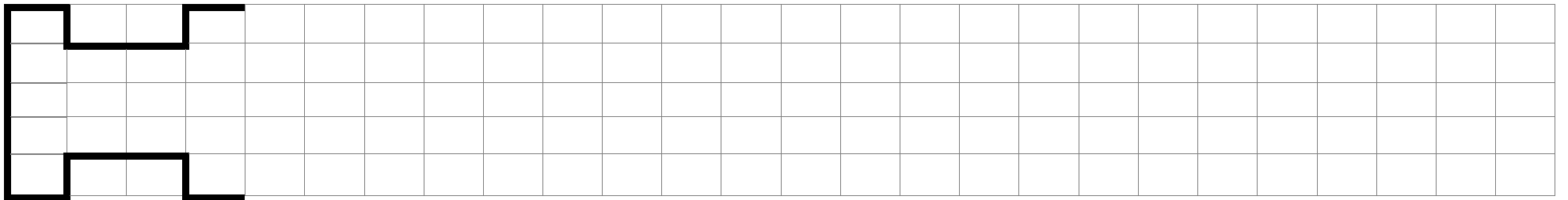
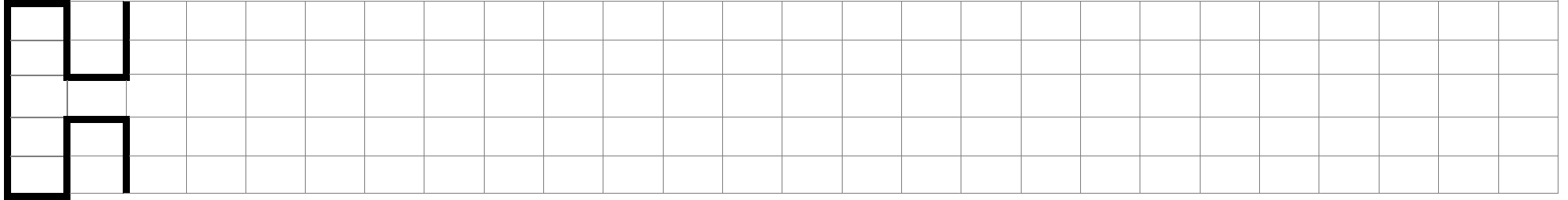
Actividades para mejorar la psicomotricidad

Sigue los huevos para unir la gallina y el pollito

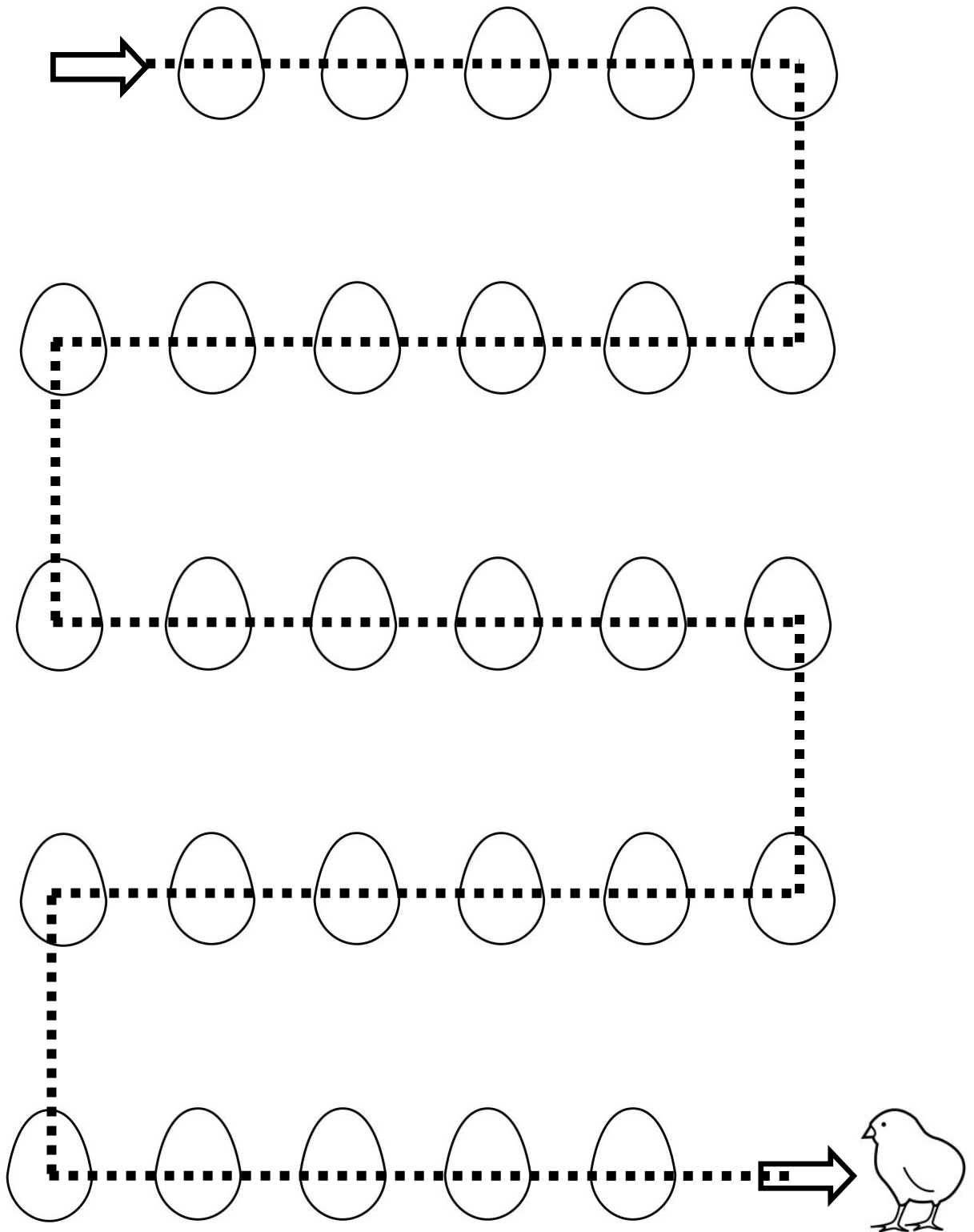
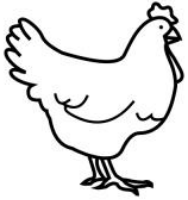

Actividades para mejorar la psicomotricidad

Sigue los huevos para unir la gallina y el pollito

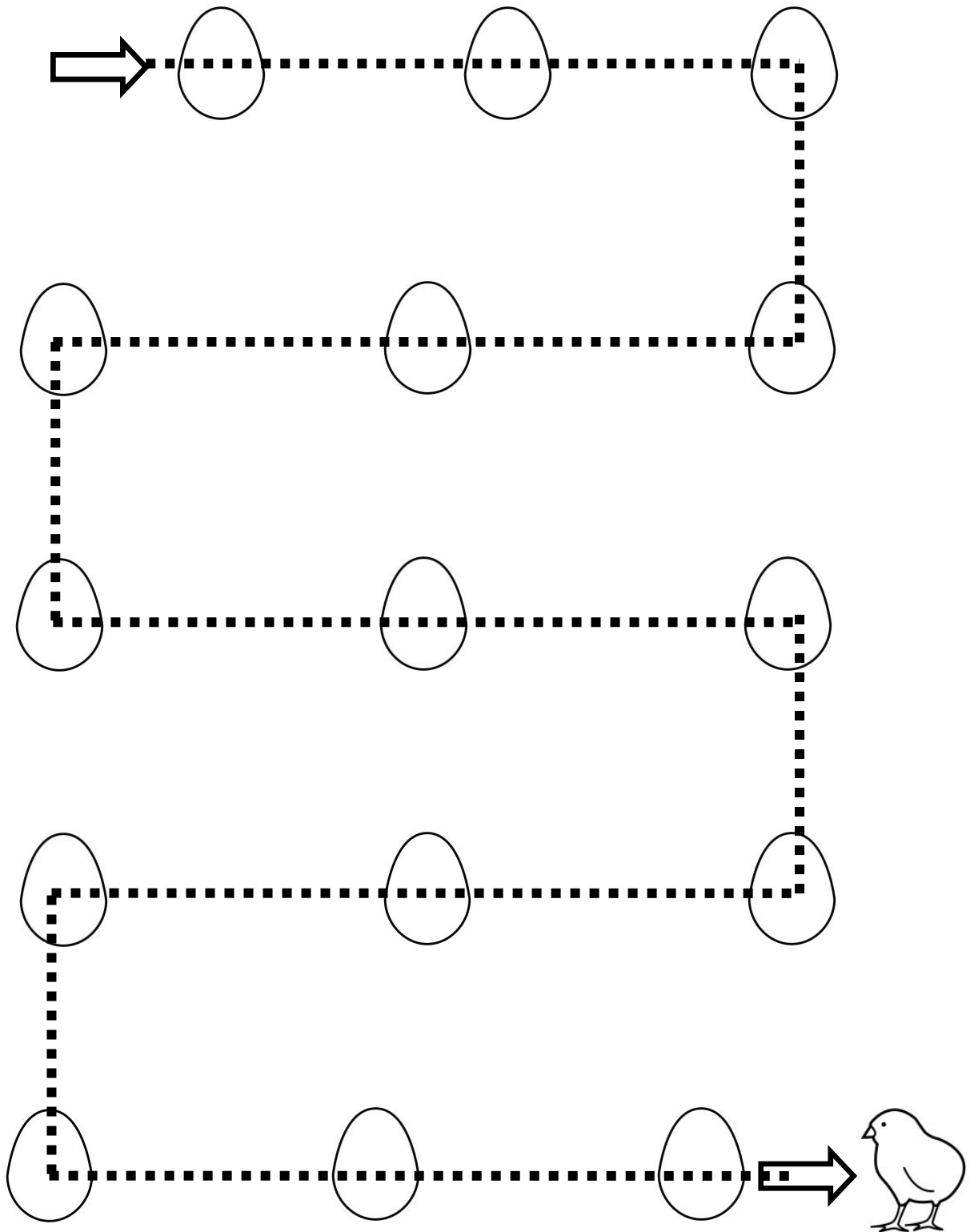
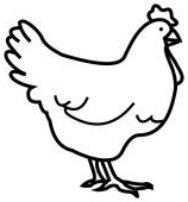

Actividades para mejorar la psicomotricidad

Sigue los huevos para unir la gallina y el pollito

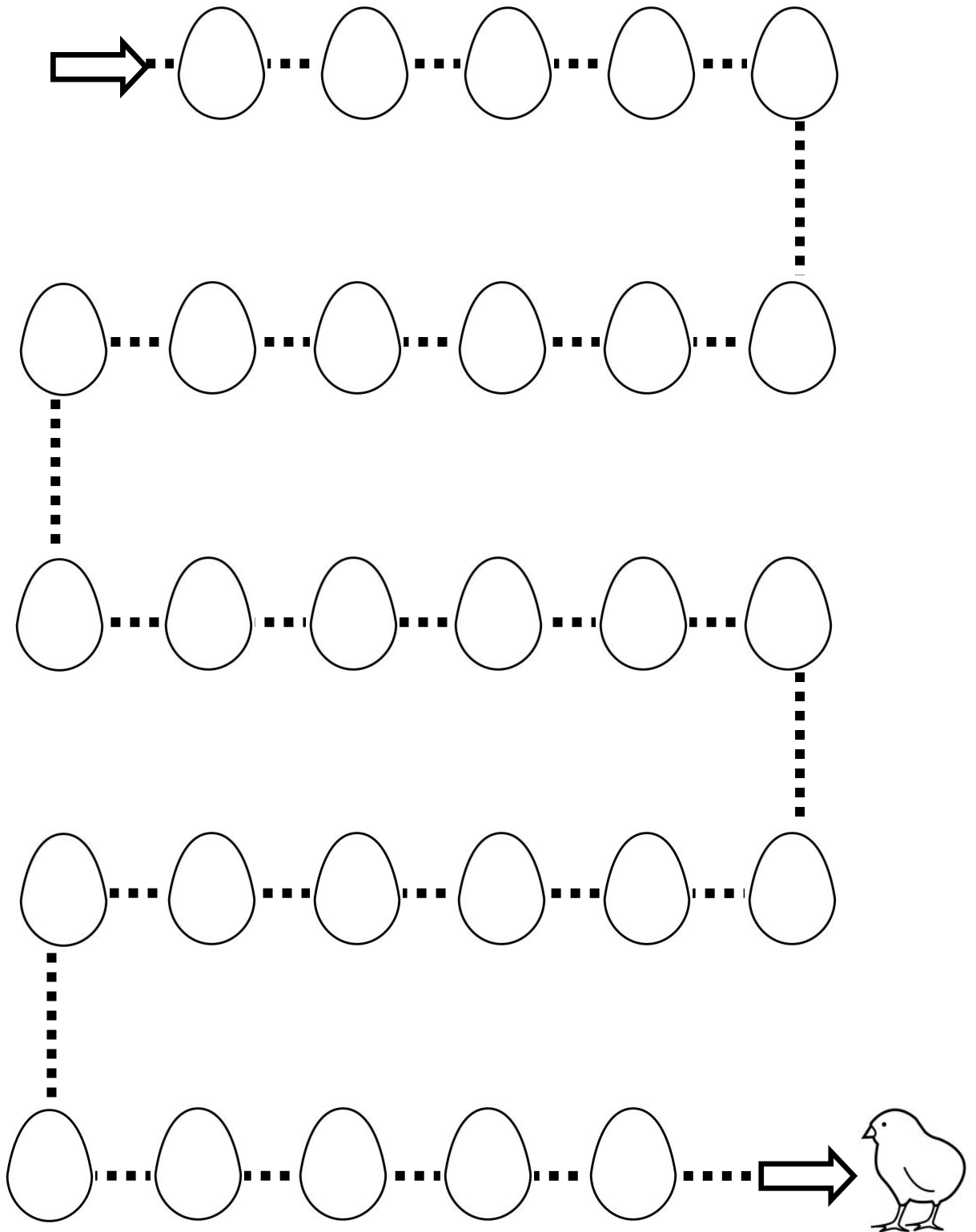
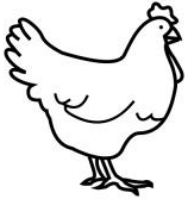

Actividades para mejorar la psicomotricidad

Sigue los huevos para unir la gallina y el pollito

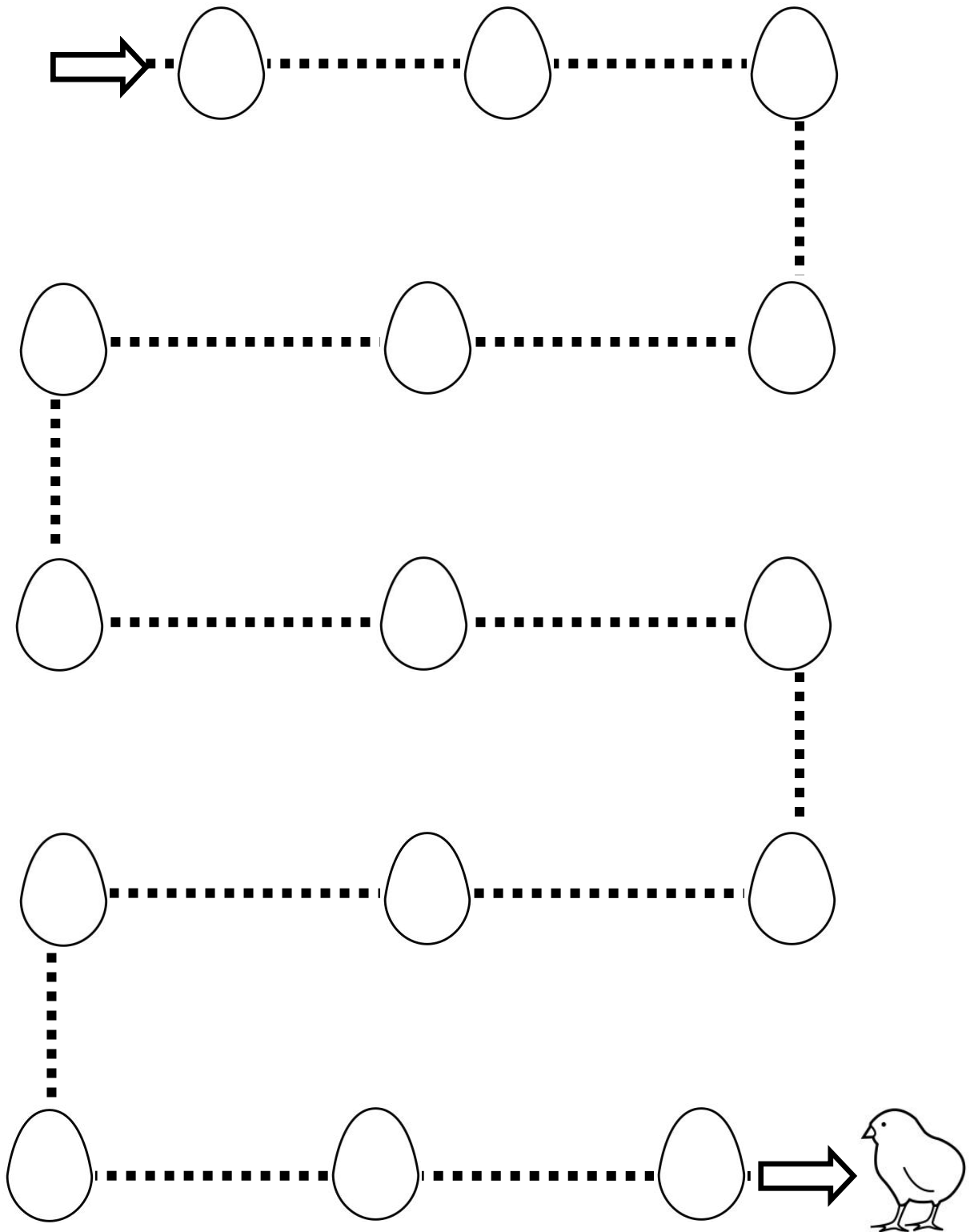
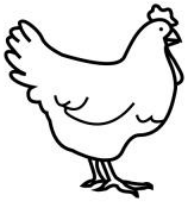

Actividades para mejorar la psicomotricidad

Sigue los huevos para unir la gallina y el pollito

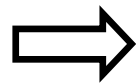
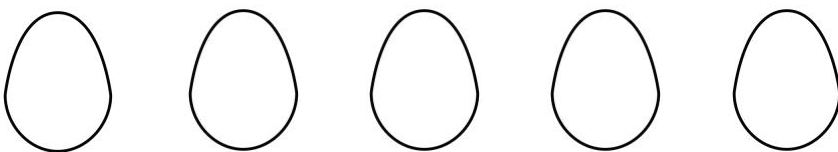
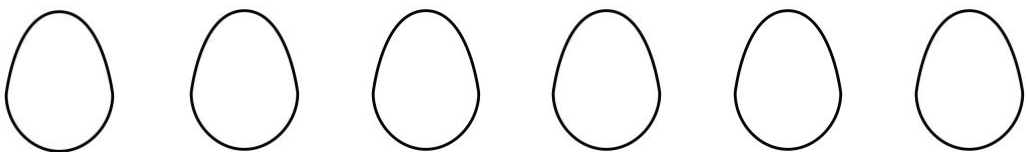
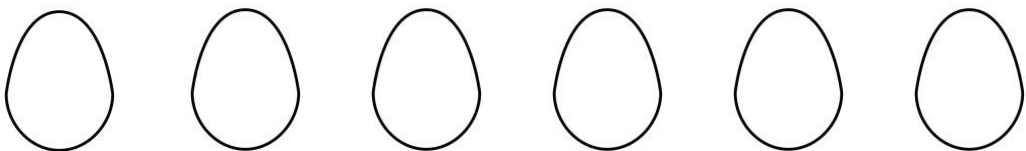
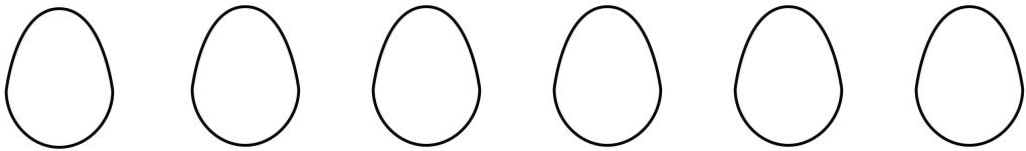
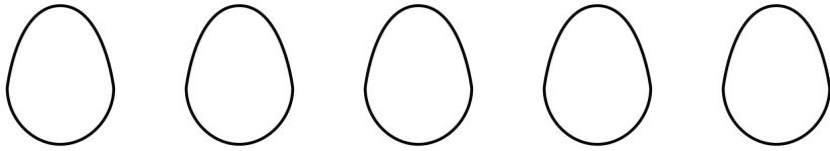
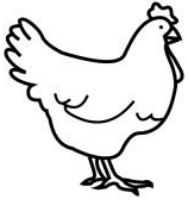

Actividades para mejorar la psicomotricidad

Sigue los huevos para unir la gallina y el pollito

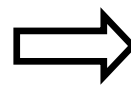
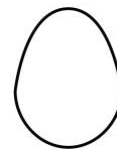
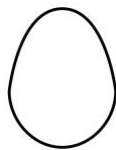
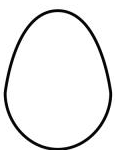
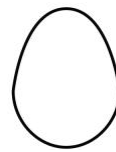
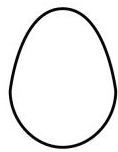
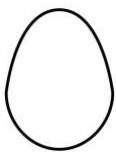
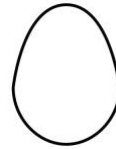
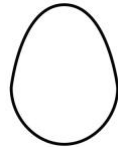
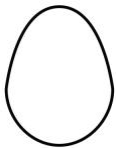
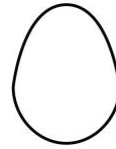
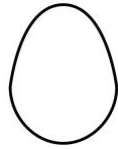
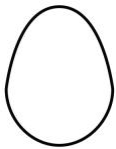
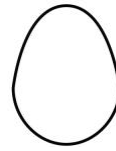
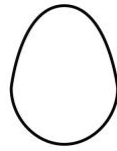
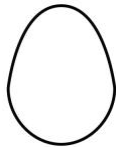
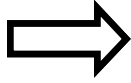
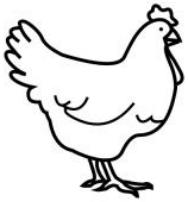

Actividades para mejorar la psicomotricidad

Sigue los corazones para unir a la mama y a su bebe

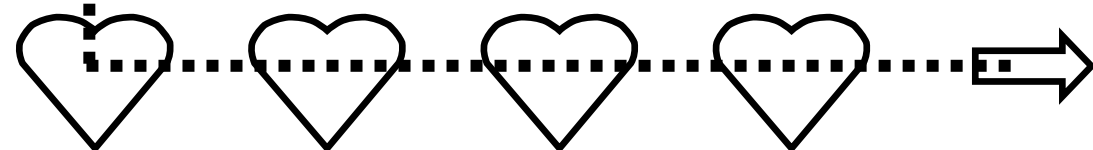
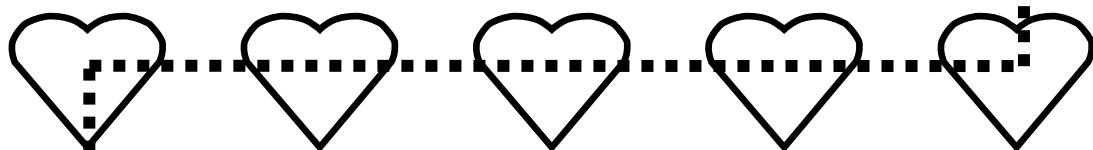
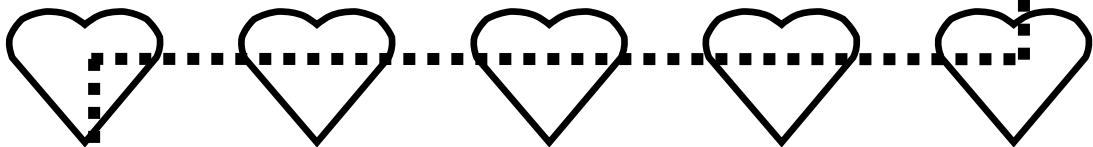
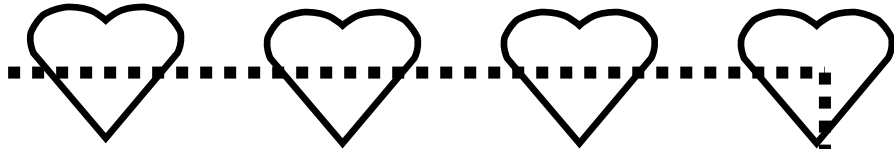

Actividades para mejorar la psicomotricidad

Sigue los corazones para unir a la mama y a su bebe

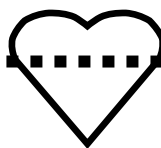
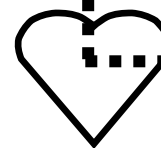
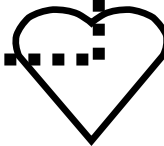
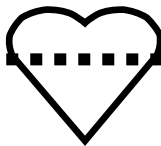
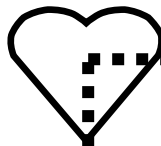
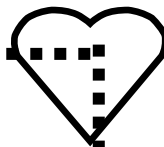
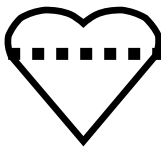
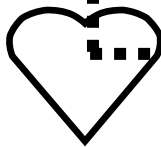
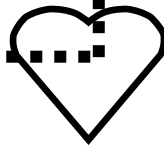
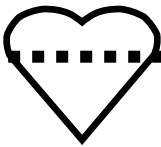
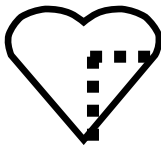
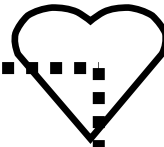
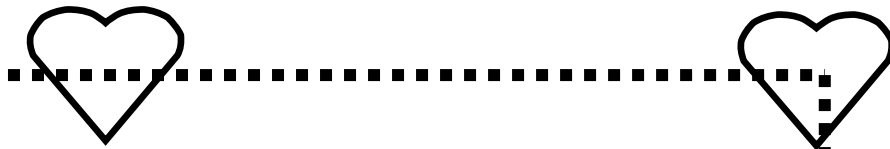
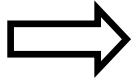

Actividades para mejorar la psicomotricidad

Sigue los corazones para unir a la mama y a su bebe

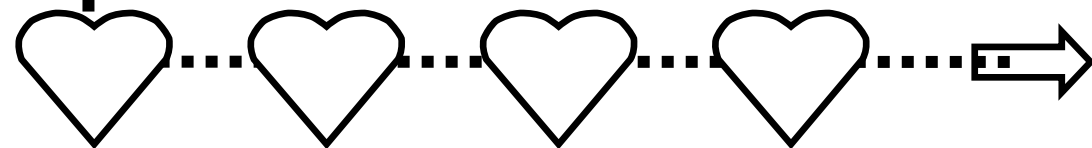
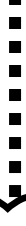
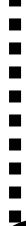
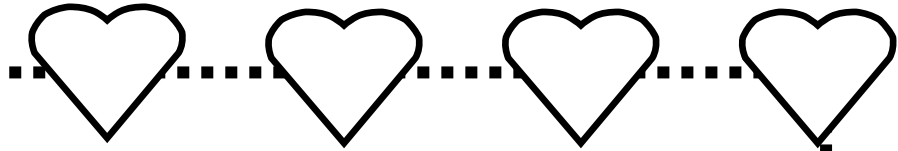

Actividades para mejorar la psicomotricidad

Sigue los corazones para unir a la mama y a su bebe

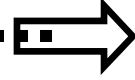
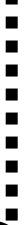
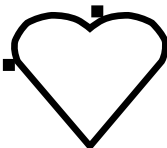
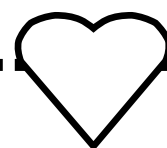
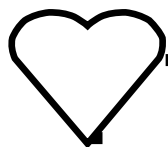

Actividades para mejorar la psicomotricidad

Sigue los corazones para unir a la mama y a su bebe

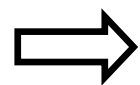
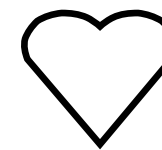
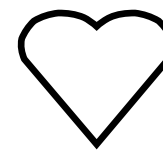
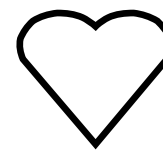
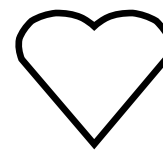
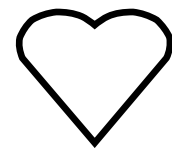
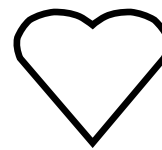
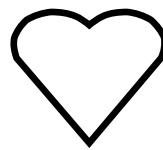
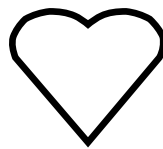
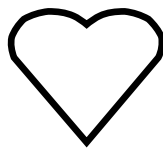
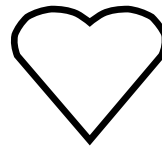
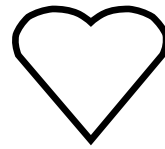

Actividades para mejorar la psicomotricidad

Sigue los corazones para unir a la mama y a su bebe

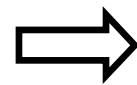

Actividades para mejorar la psicomotricidad

Sigue las caras para unir al niño y a la niña

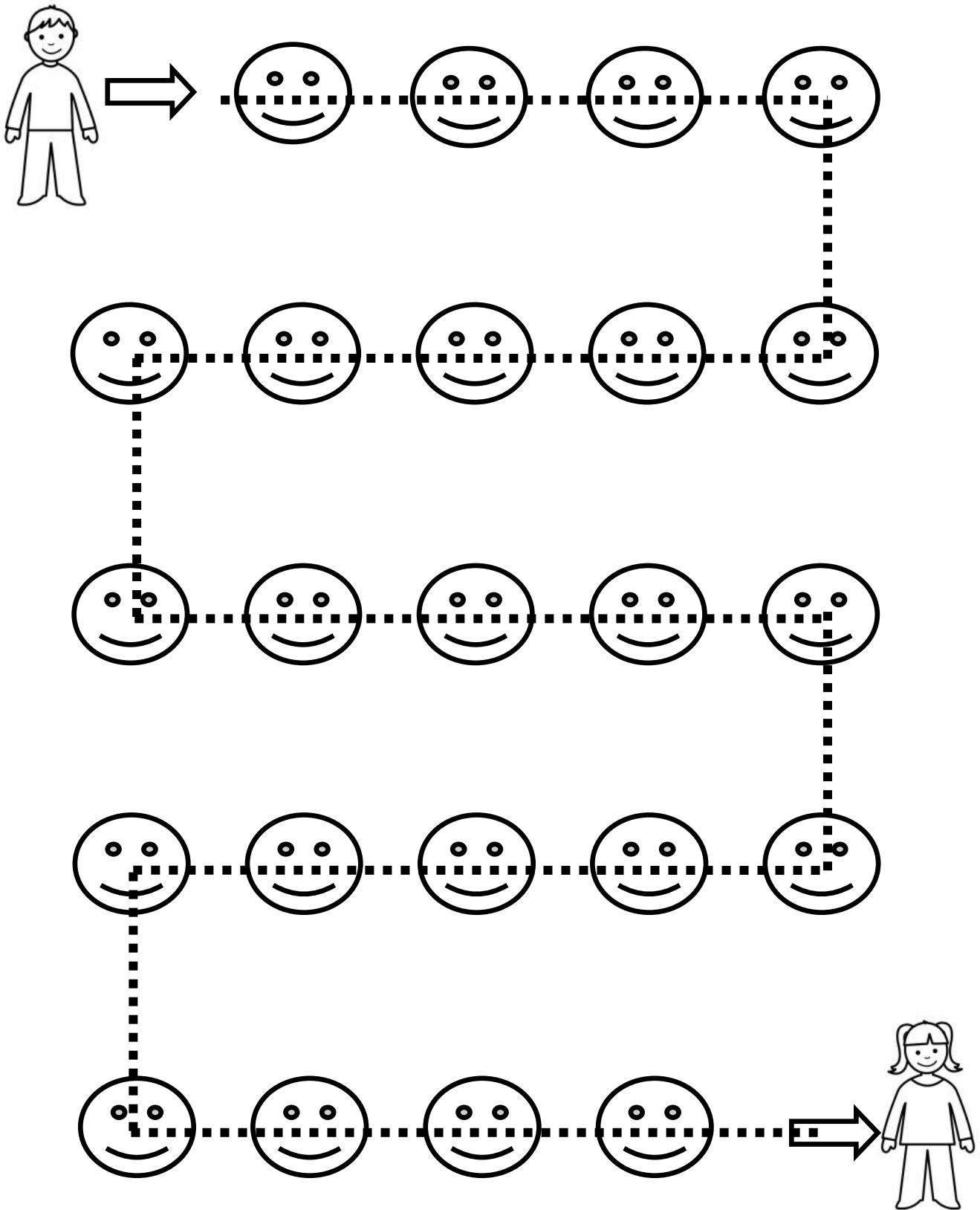

Actividades para mejorar la psicomotricidad

Sigue las caras para unir al niño y a la niña

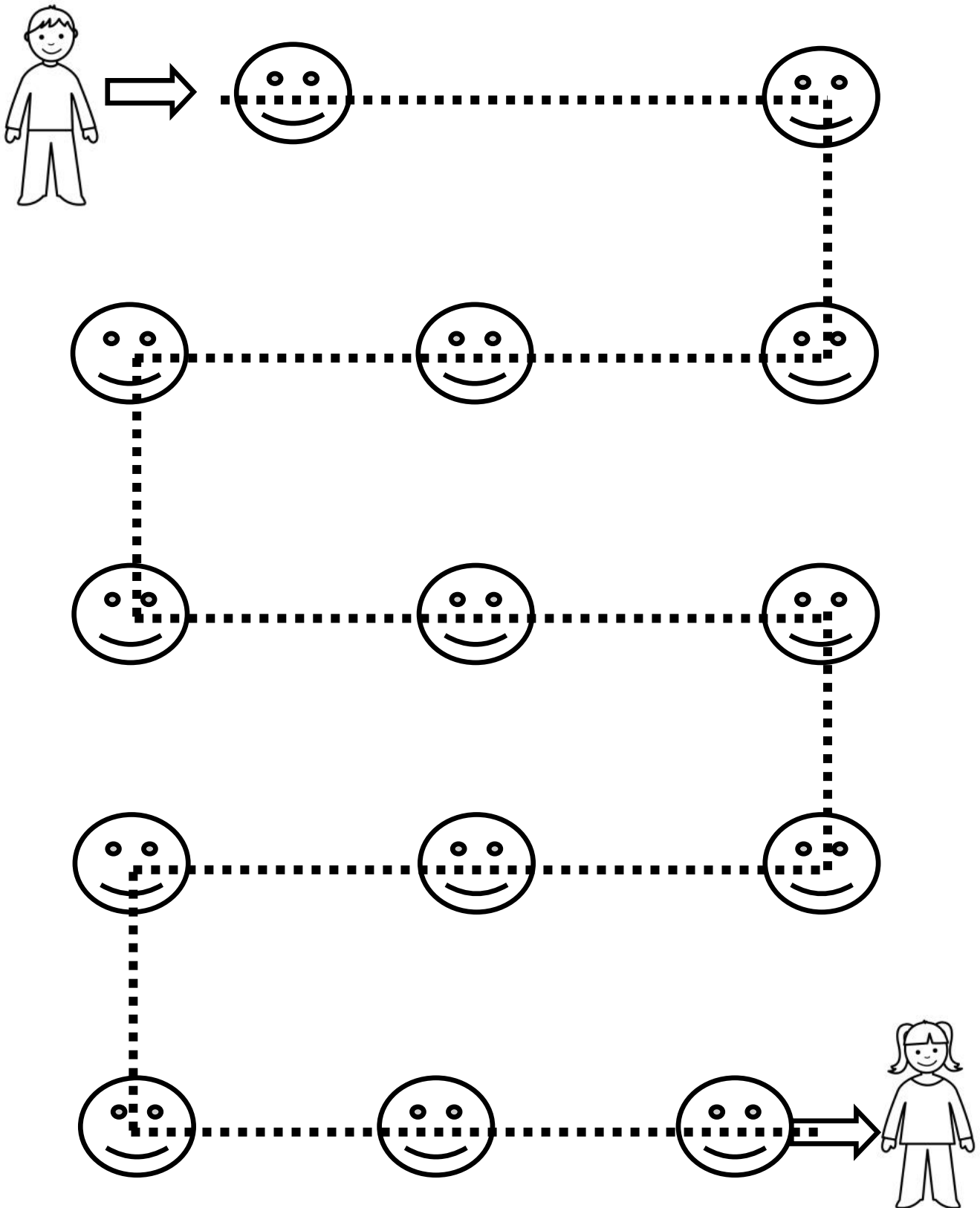

Actividades para mejorar la psicomotricidad

Sigue las caras para unir al niño y a la niña

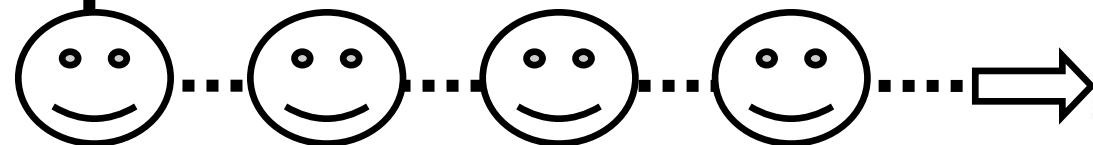
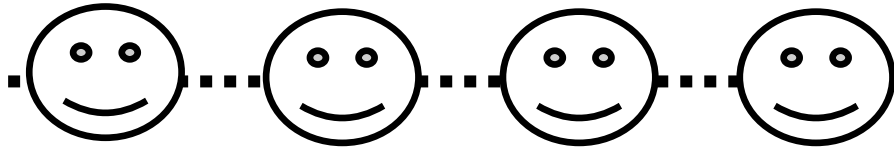
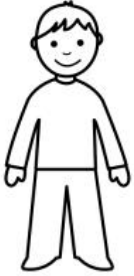

Actividades para mejorar la psicomotricidad

Sigue las caras para unir al niño y a la niña

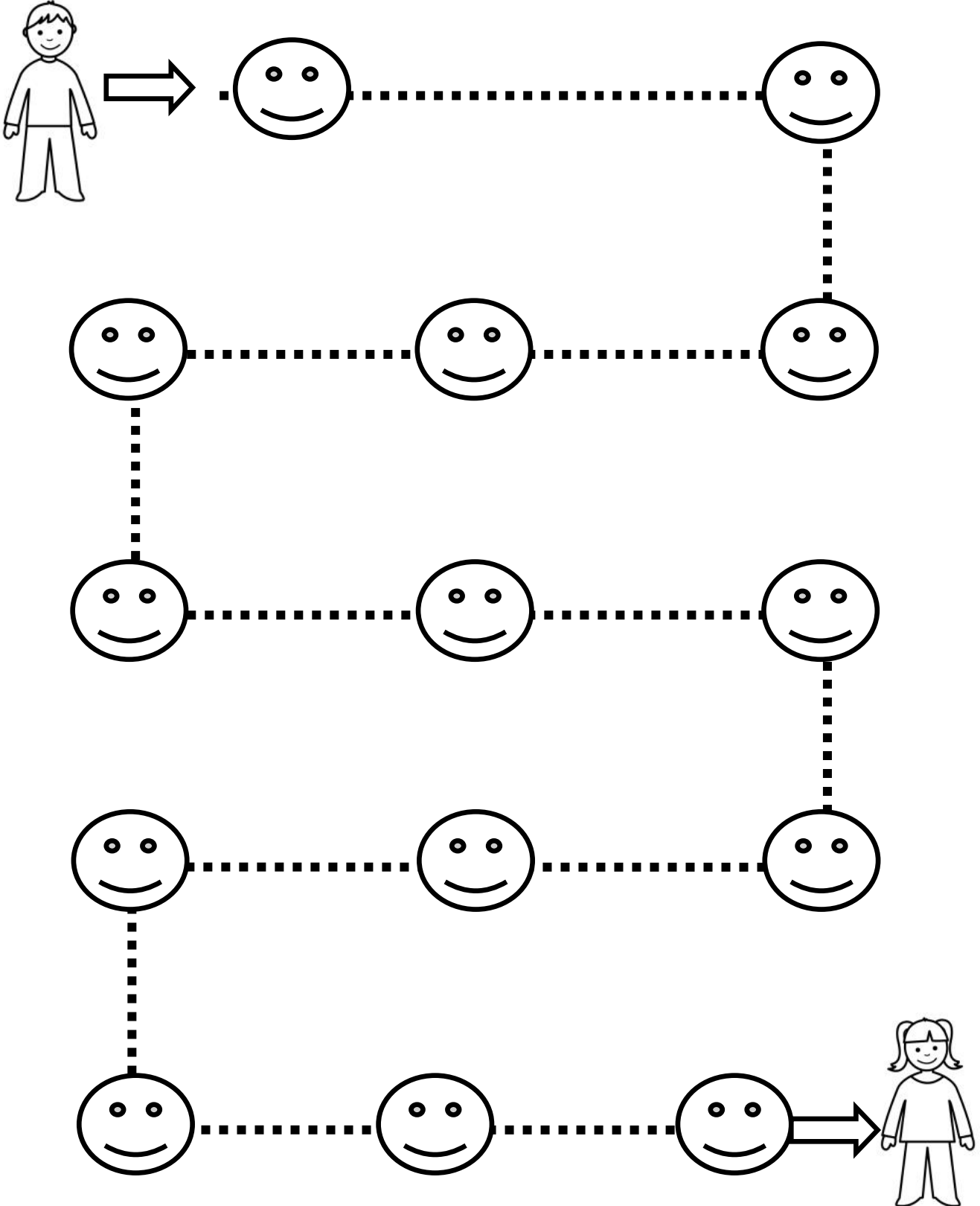

Actividades para mejorar la psicomotricidad

Sigue las caras para unir al niño y a la niña

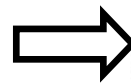
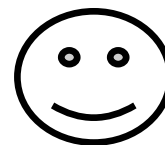
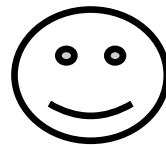
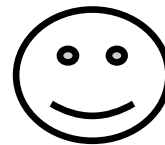
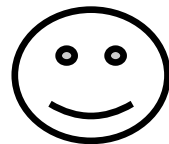
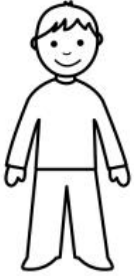

Actividades para mejorar la psicomotricidad

Sigue las caras para unir al niño y a la niña

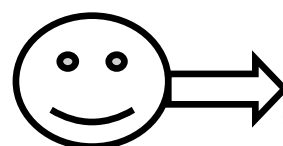
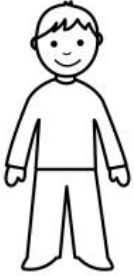

Actividades para mejorar la psicomotricidad

Sigue los círculos para unir al niño con su balón

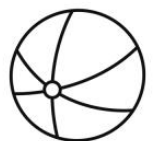
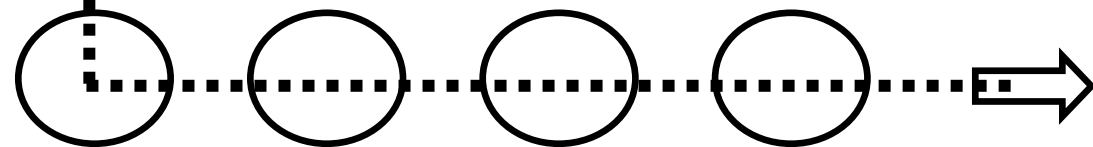
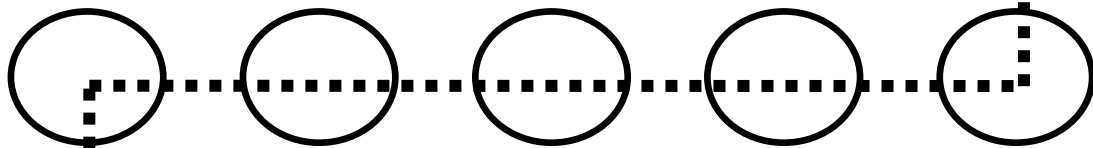
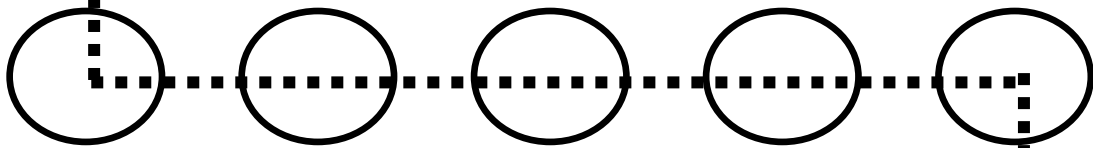
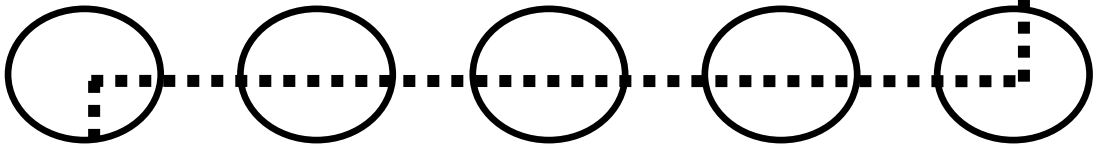
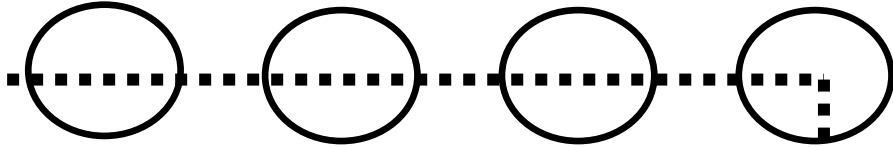
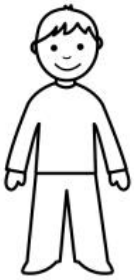

Actividades para mejorar la psicomotricidad

Sigue los círculos para unir al niño con su balón

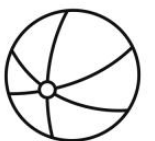
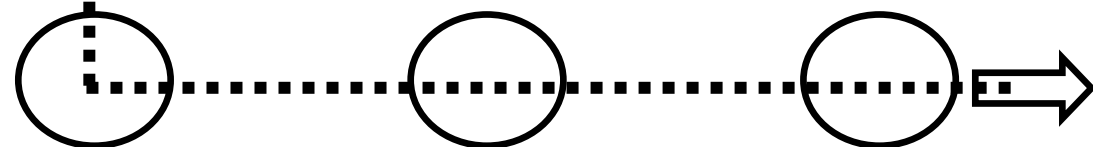
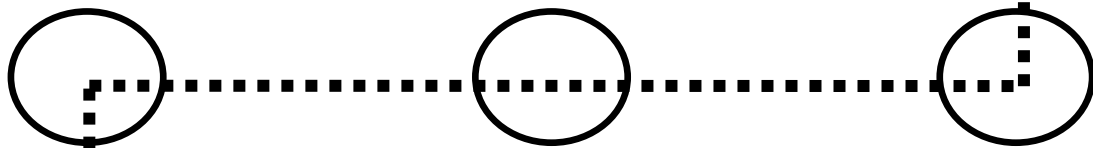
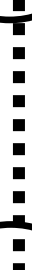
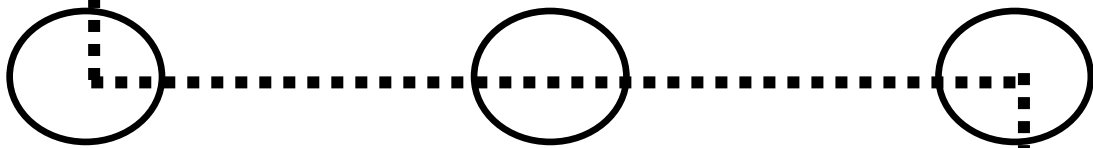
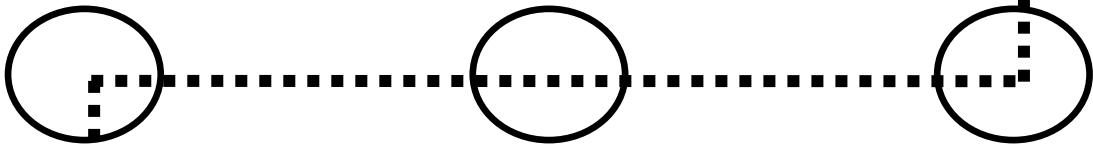
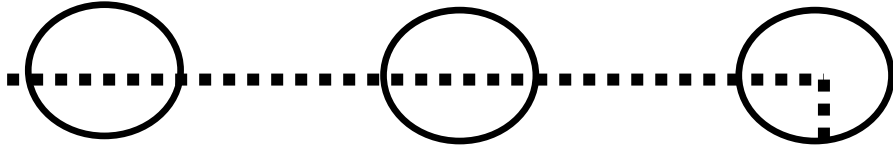
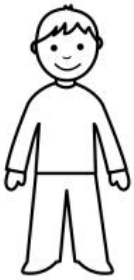

Actividades para mejorar la psicomotricidad

Sigue los círculos para unir al niño con su balón

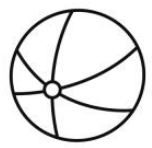
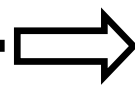
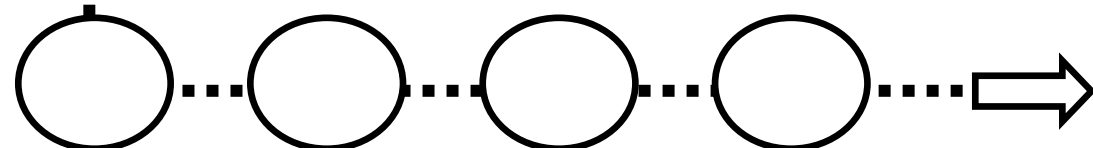
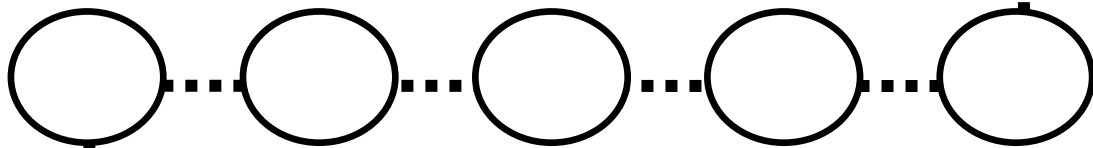
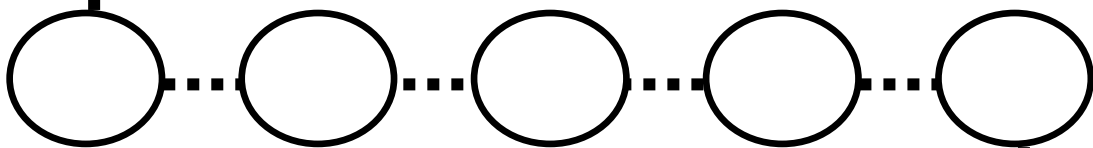
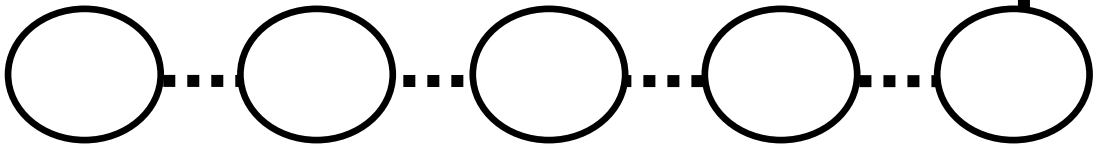
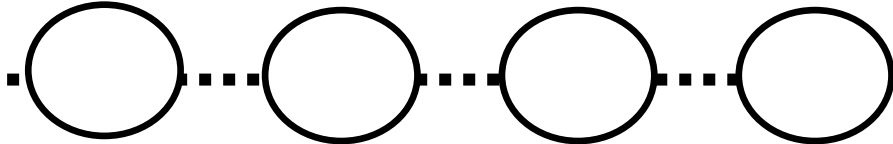
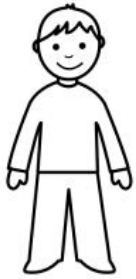

Actividades para mejorar la psicomotricidad

Sigue los círculos para unir al niño con su balón

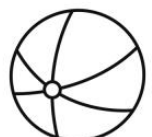
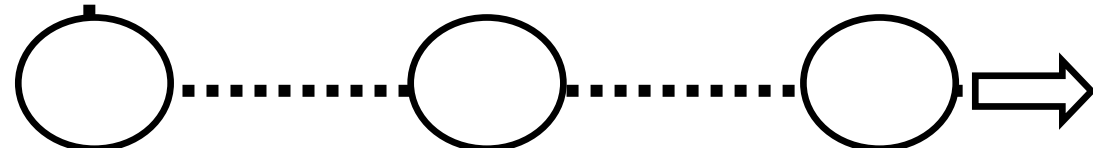
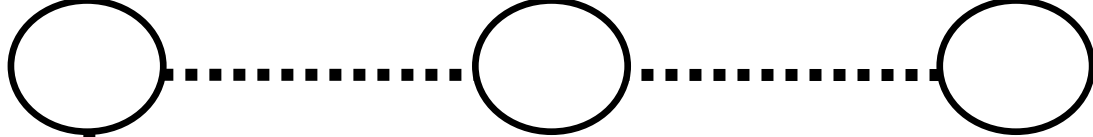
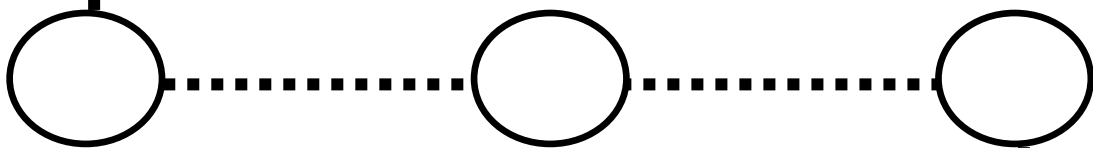
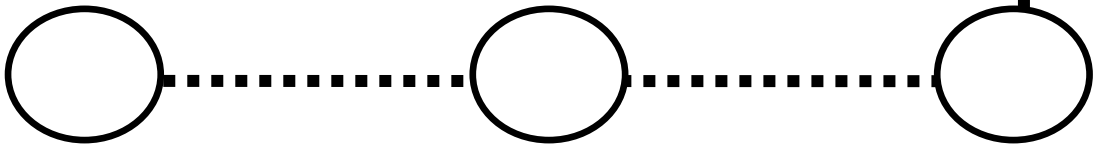
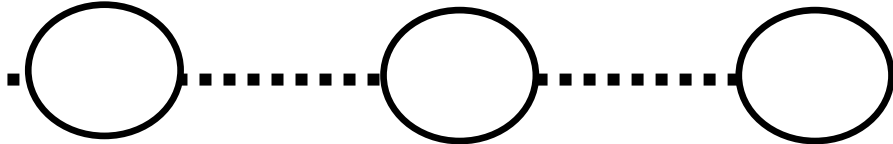
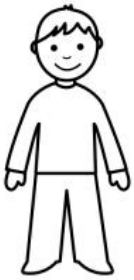

Actividades para mejorar la psicomotricidad

Sigue los círculos para unir al niño con su balón

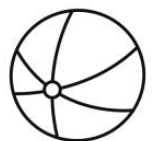
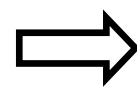
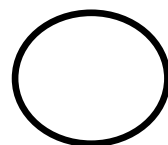
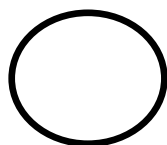
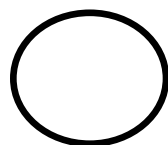
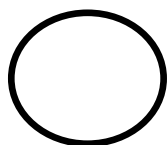
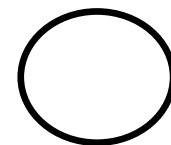
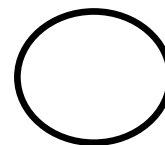
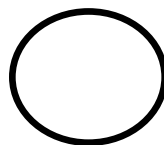
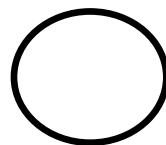
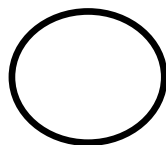
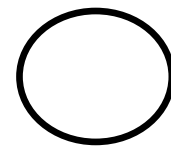
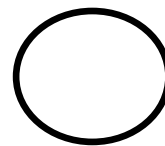
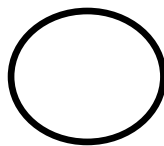
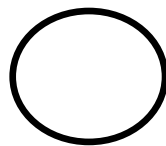
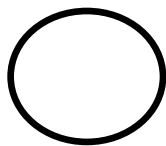
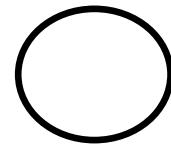
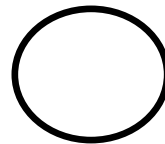
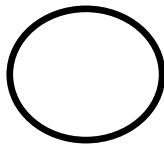
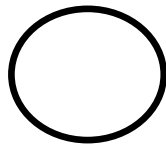
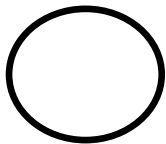
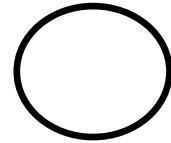
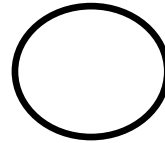
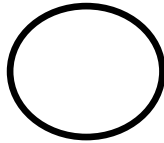
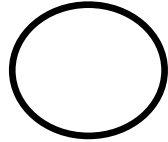
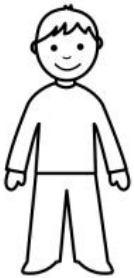

Actividades para mejorar la psicomotricidad

Sigue los círculos para unir al niño con su balón

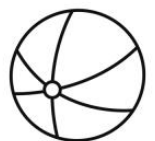
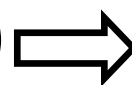
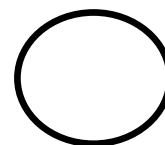
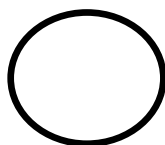
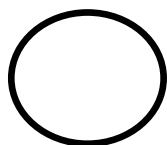
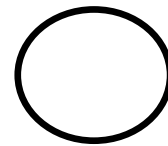
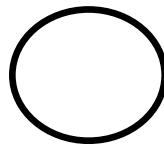
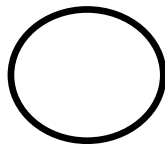
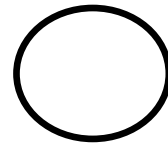
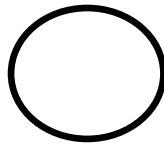
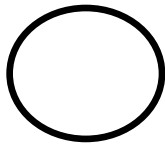
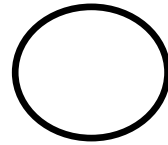
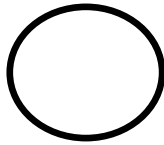
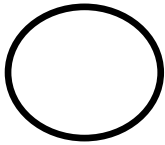
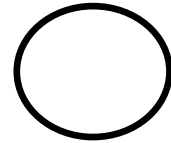
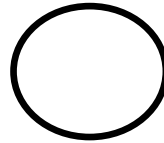
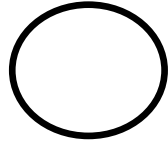
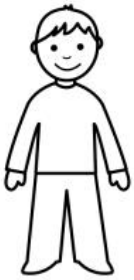

Actividades para mejorar la psicomotricidad

Sigue los rayos para unir la nube con la tierra

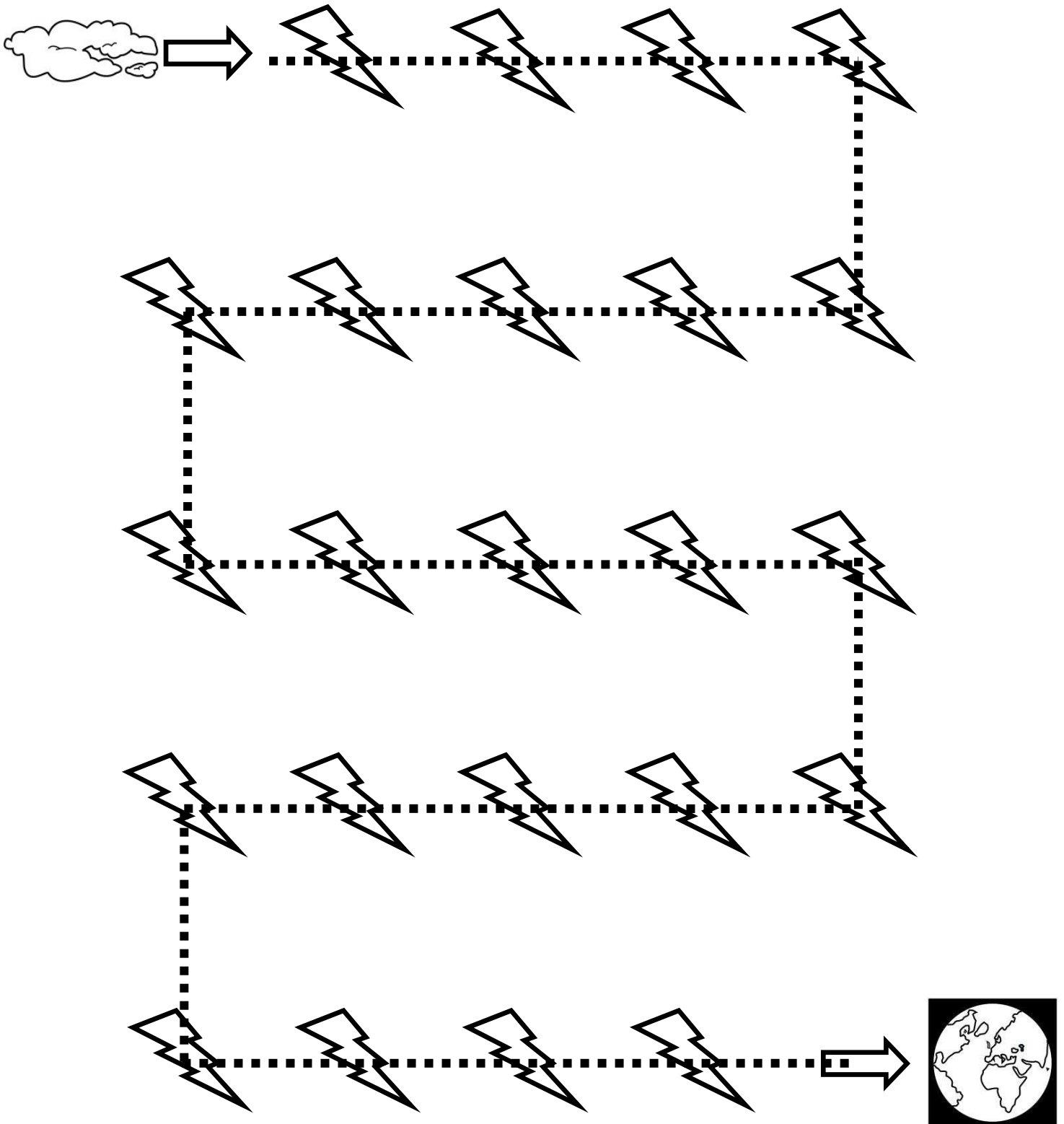

Actividades para mejorar la psicomotricidad

Sigue las caras para unir al niño y a la niña

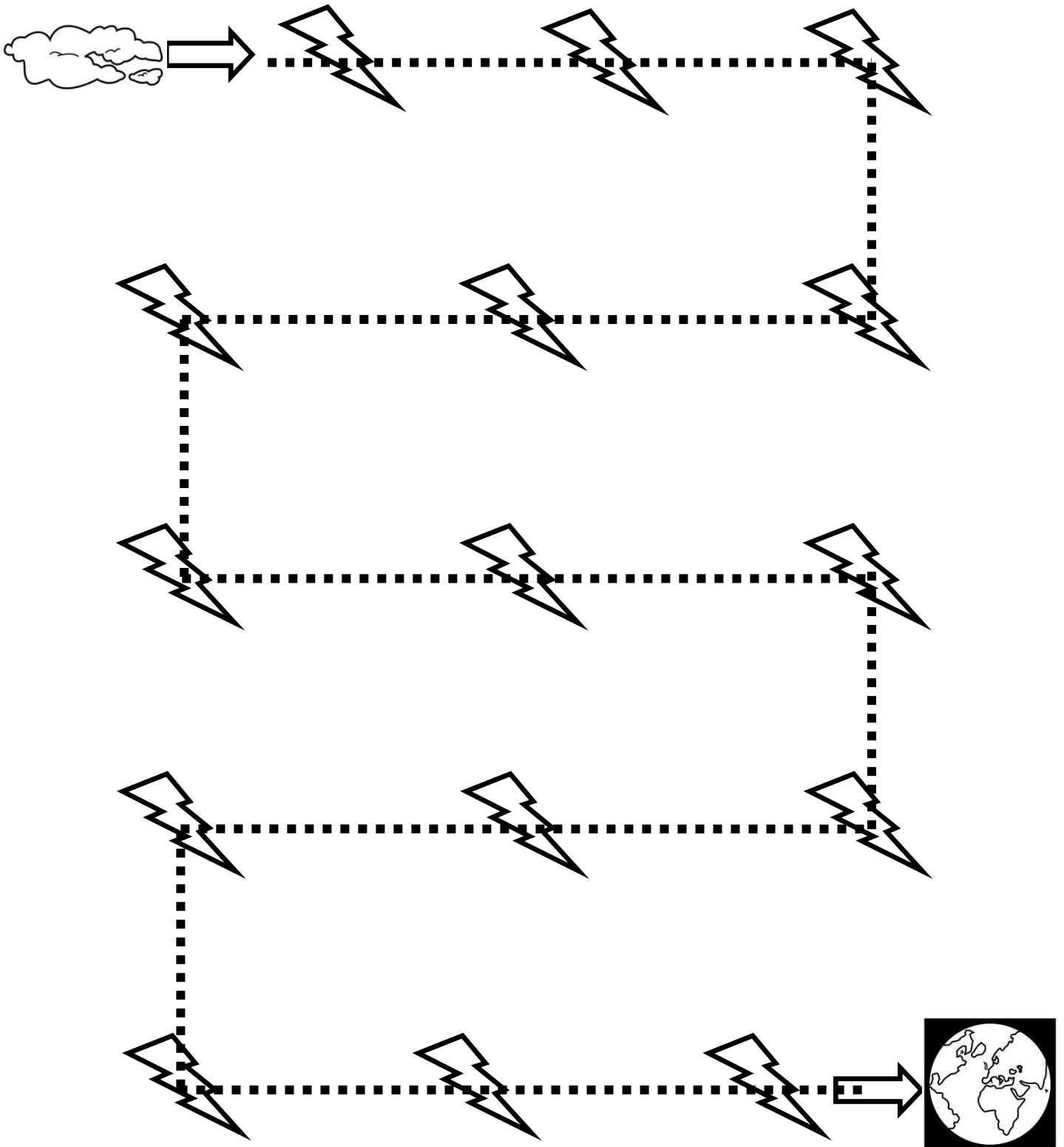

Actividades para mejorar la psicomotricidad

Sigue las caras para unir al niño y a la niña

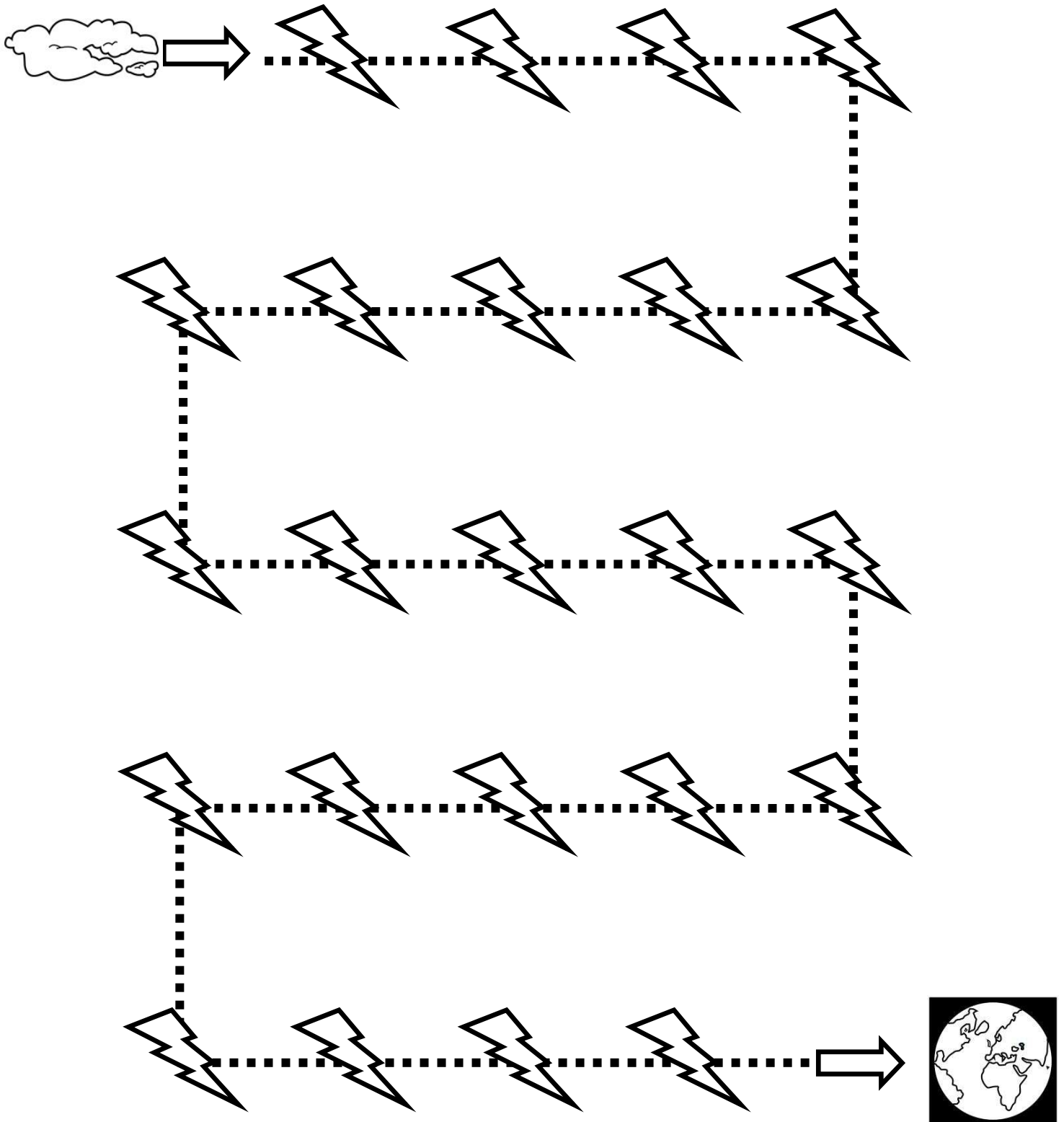

Actividades para mejorar la psicomotricidad

Sigue las caras para unir al niño y a la niña

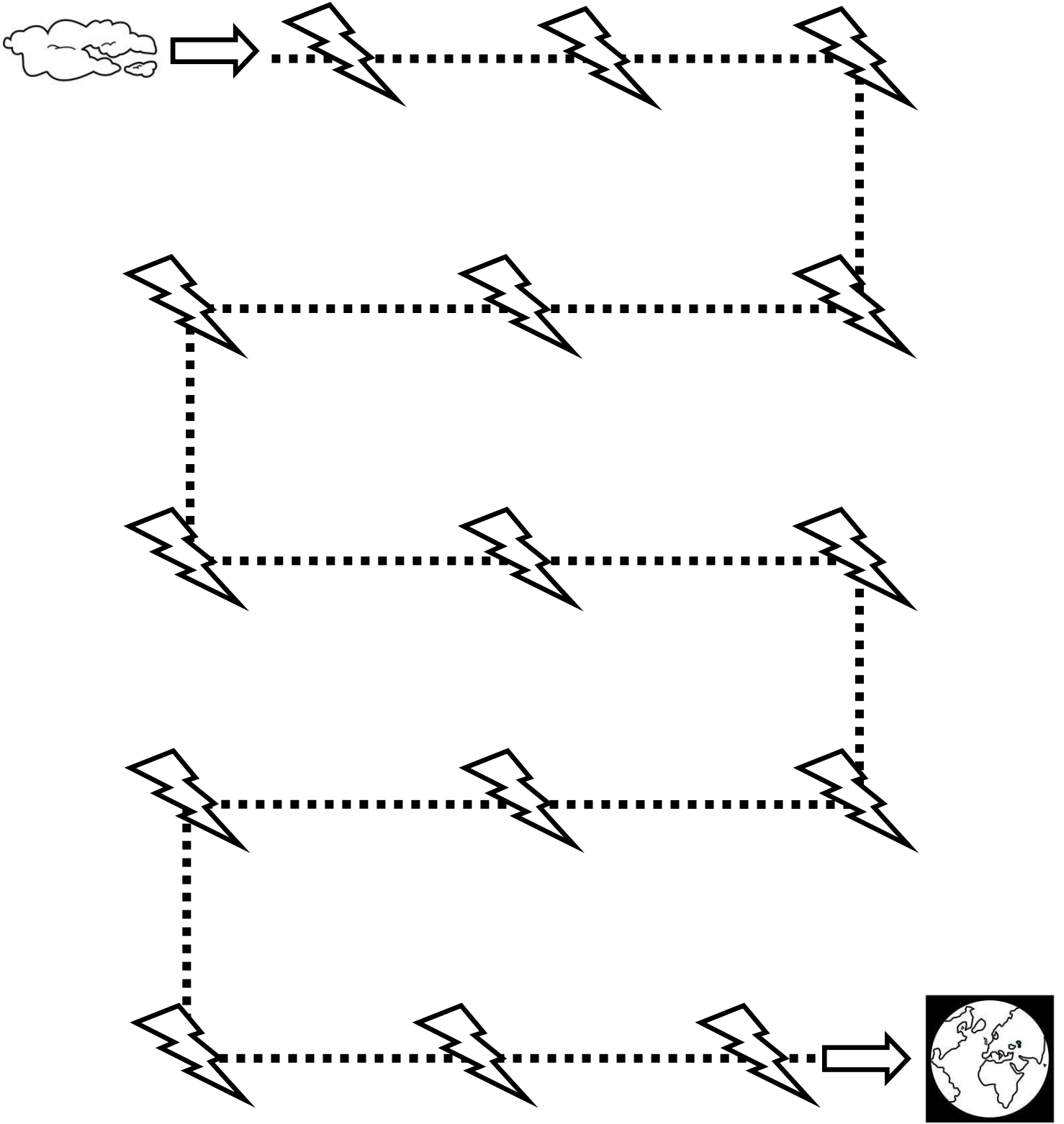

Actividades para mejorar la psicomotricidad

Sigue las caras para unir al niño y a la niña

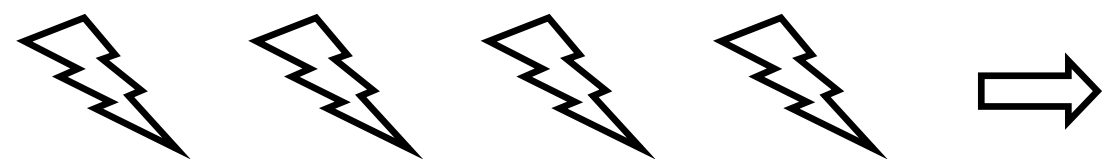
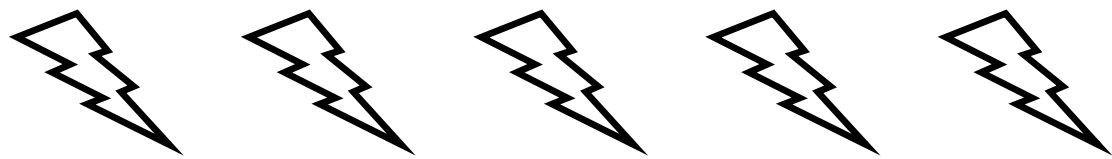
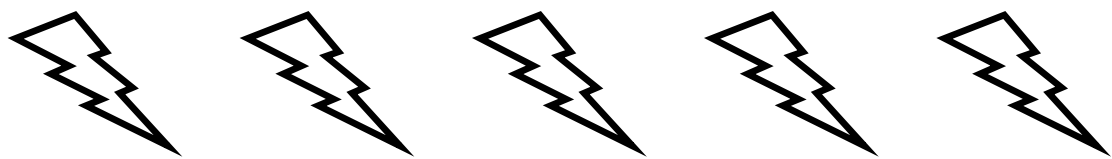
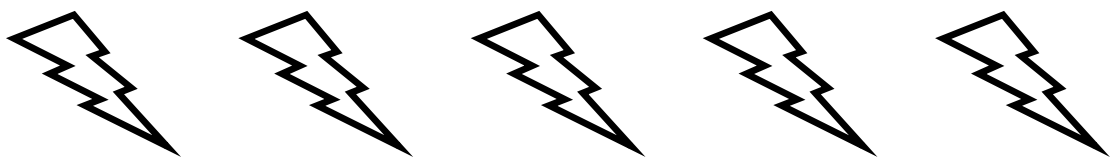
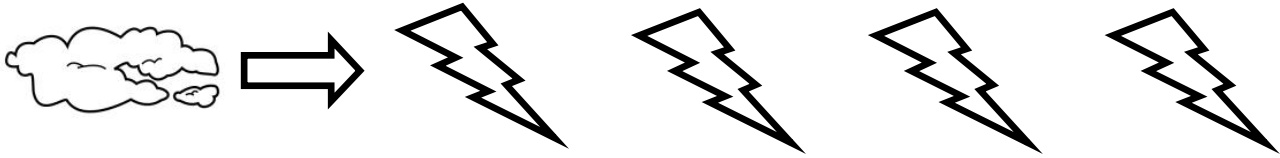

Actividades para mejorar la psicomotricidad

Sigue las caras para unir al niño y a la niña

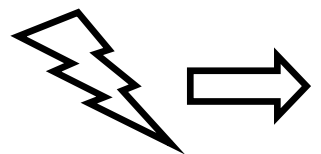
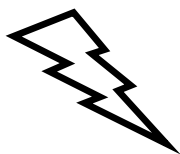
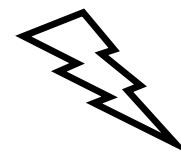
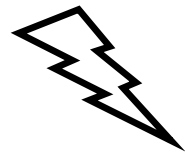
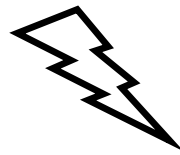
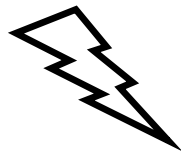
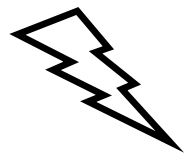
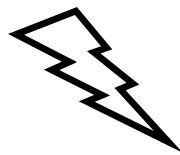
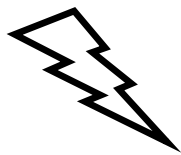
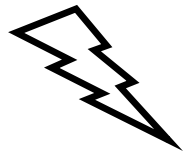
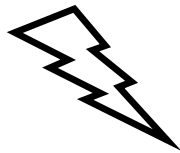
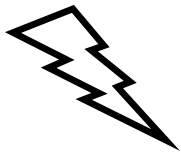
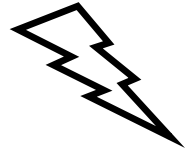
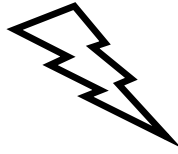
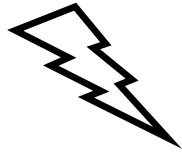

Actividades para mejorar la psicomotricidad

Sigue las estrellitas para ir desde el sol a la tierra

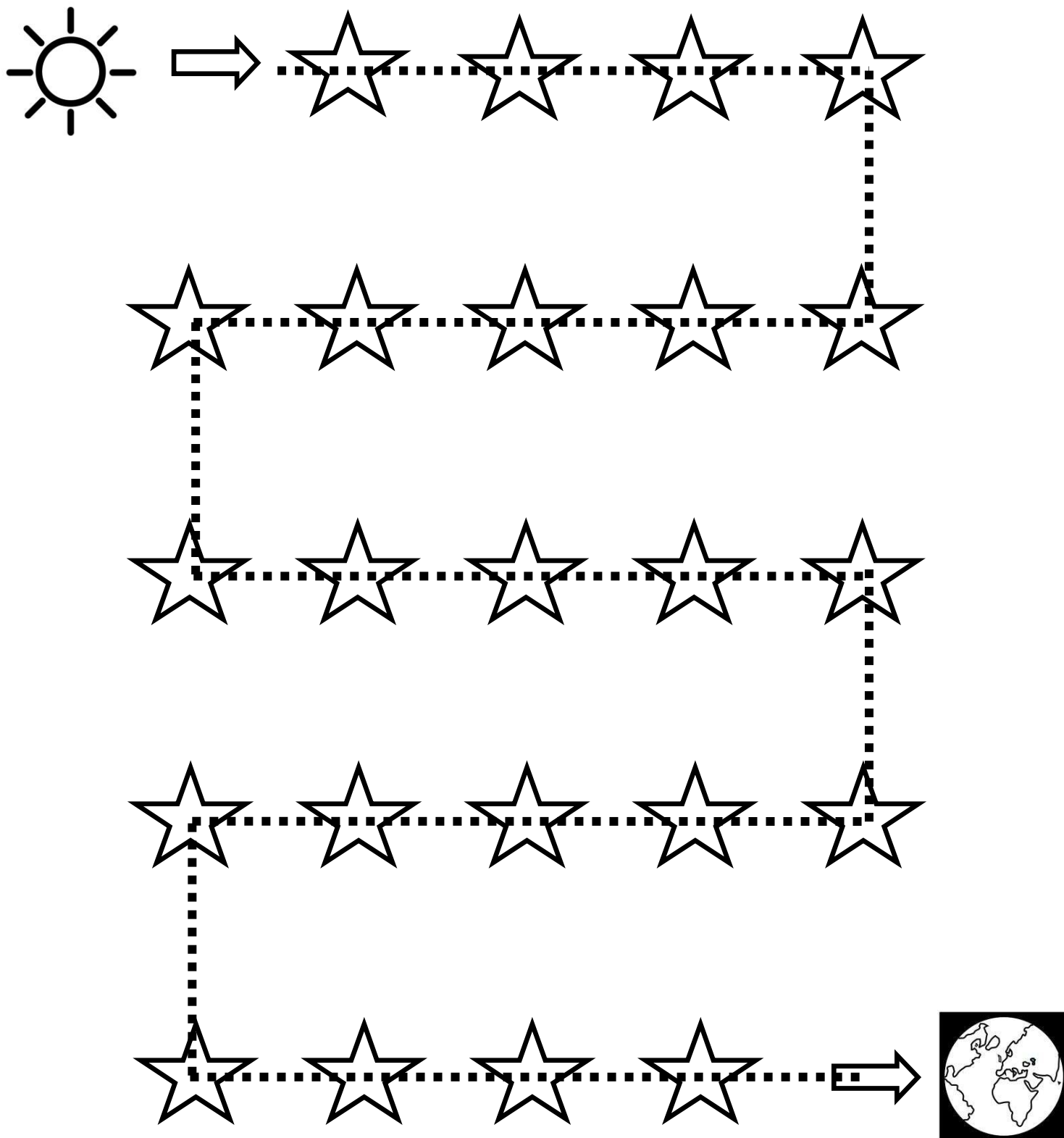

Actividades para mejorar la psicomotricidad

Sigue las estrellitas para ir desde el sol a la tierra

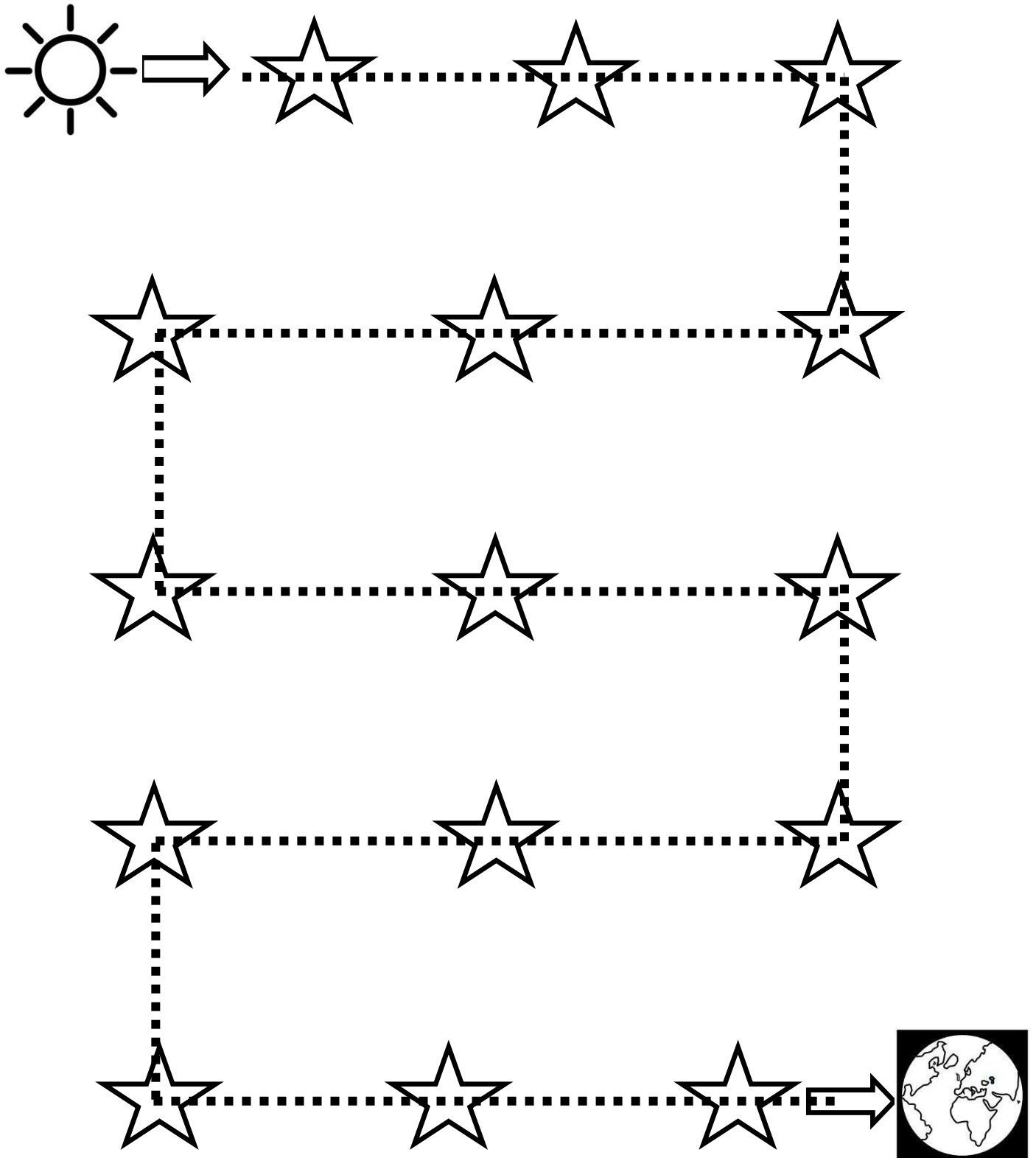

Actividades para mejorar la psicomotricidad

Sigue las estrellitas para ir desde el sol a la tierra

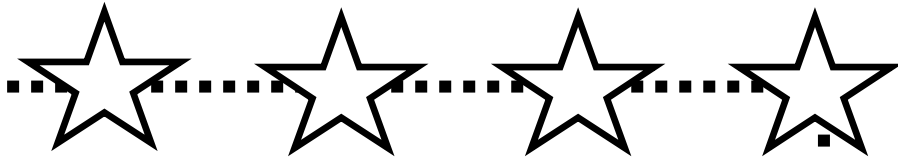
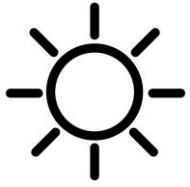

Actividades para mejorar la psicomotricidad

Sigue las estrellitas para ir desde el sol a la tierra

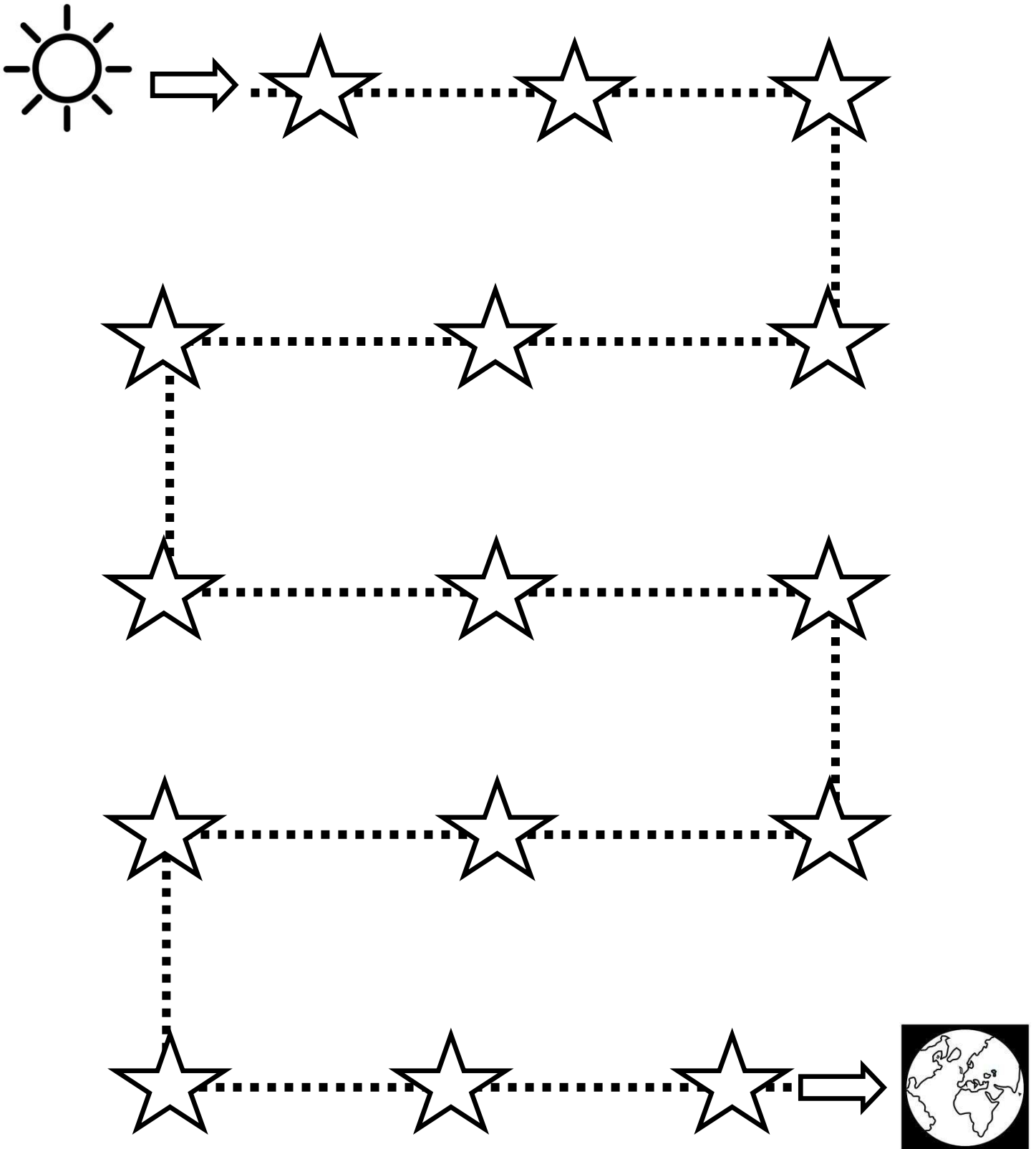

Actividades para mejorar la psicomotricidad

Sigue las estrellitas para ir desde el sol a la tierra

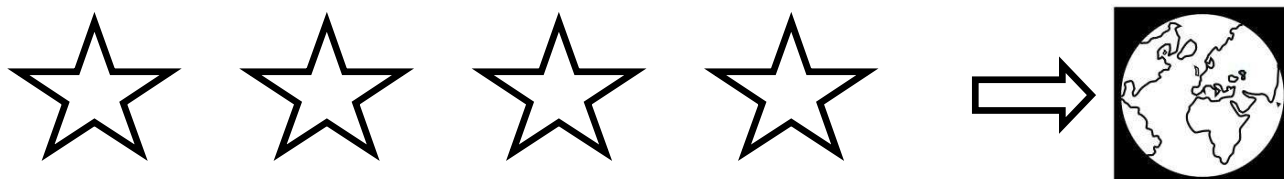
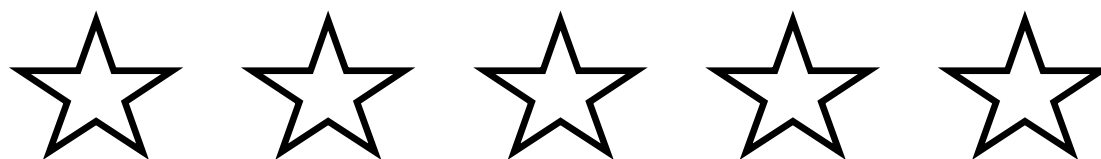
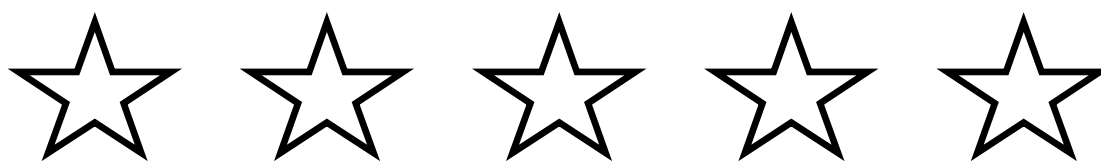
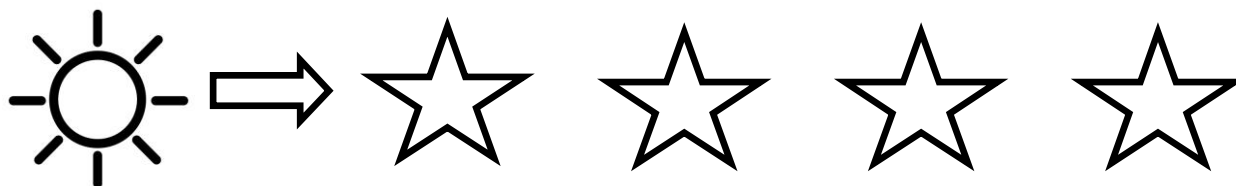

Actividades para mejorar la psicomotricidad

Sigue las estrellitas para ir desde el sol a la tierra

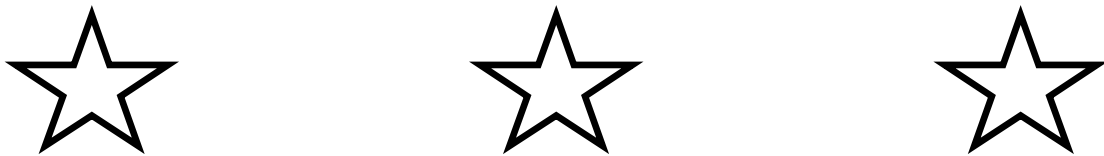
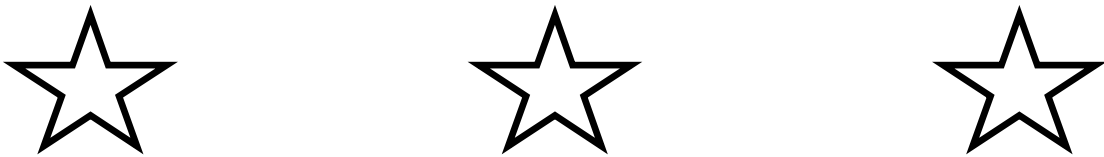

Actividades para mejorar motricidad fina

Sigue con tu lápiz las estrellitas para ir desde el sol a la tierra

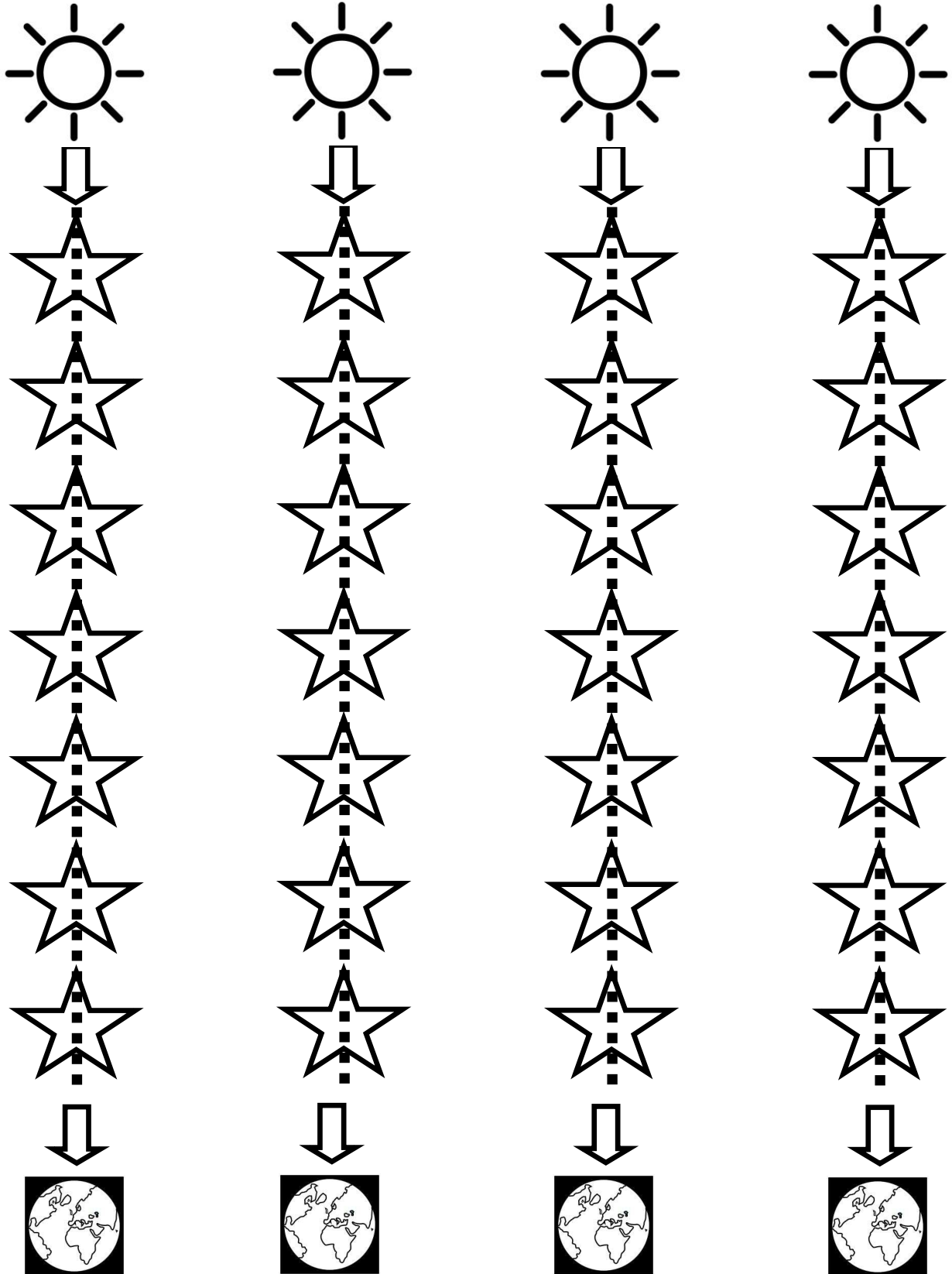

Actividades para mejorar motricidad fina

Sigue con tu lápiz las estrellitas para ir desde el sol a la tierra

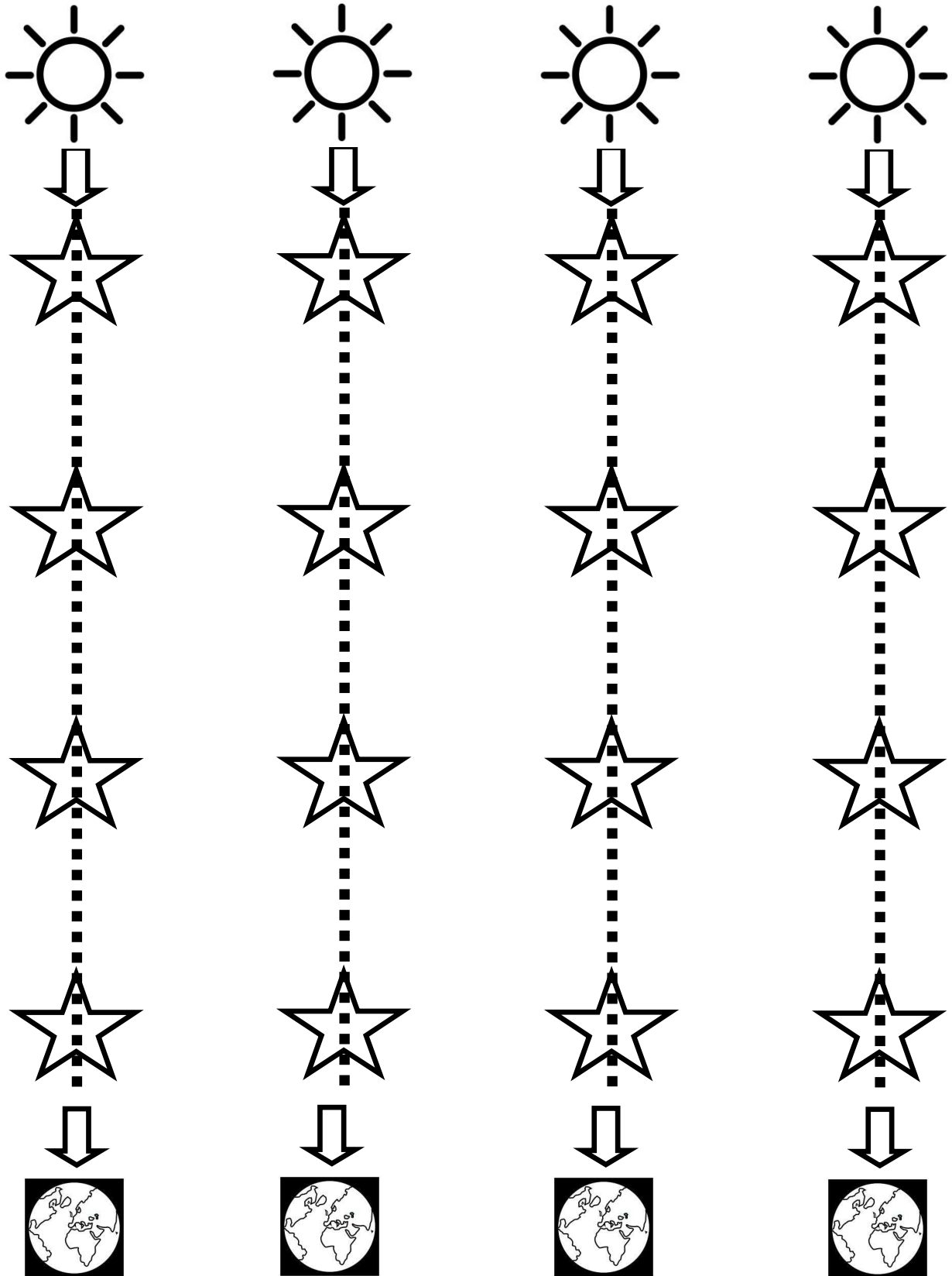

Actividades para mejorar motricidad fina

Sigue con tu lápiz las estrellitas para ir desde el sol a la tierra

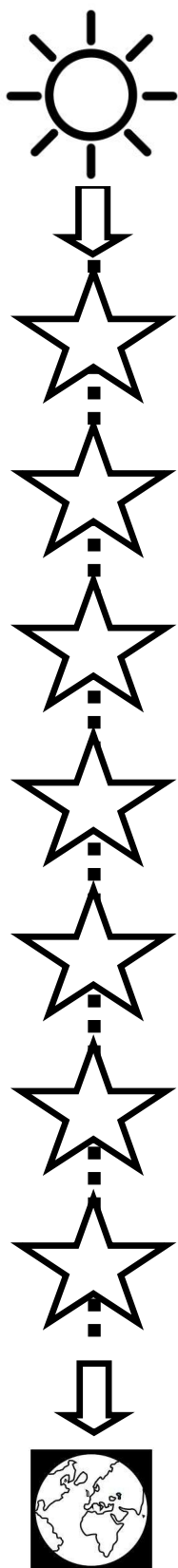
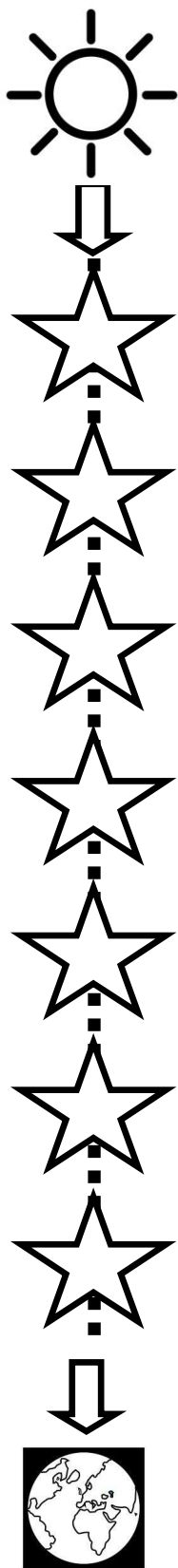
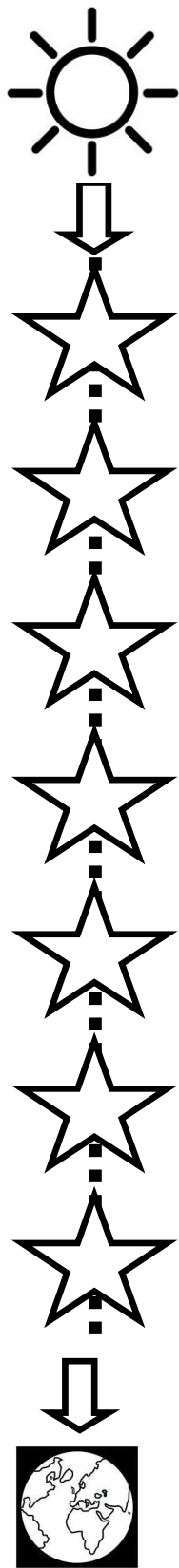
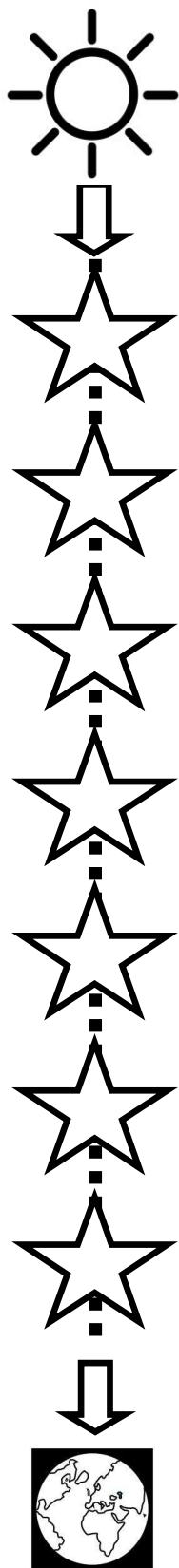

Actividades para mejorar motricidad fina

Sigue con tu lápiz las estrellitas para ir desde el sol a la tierra

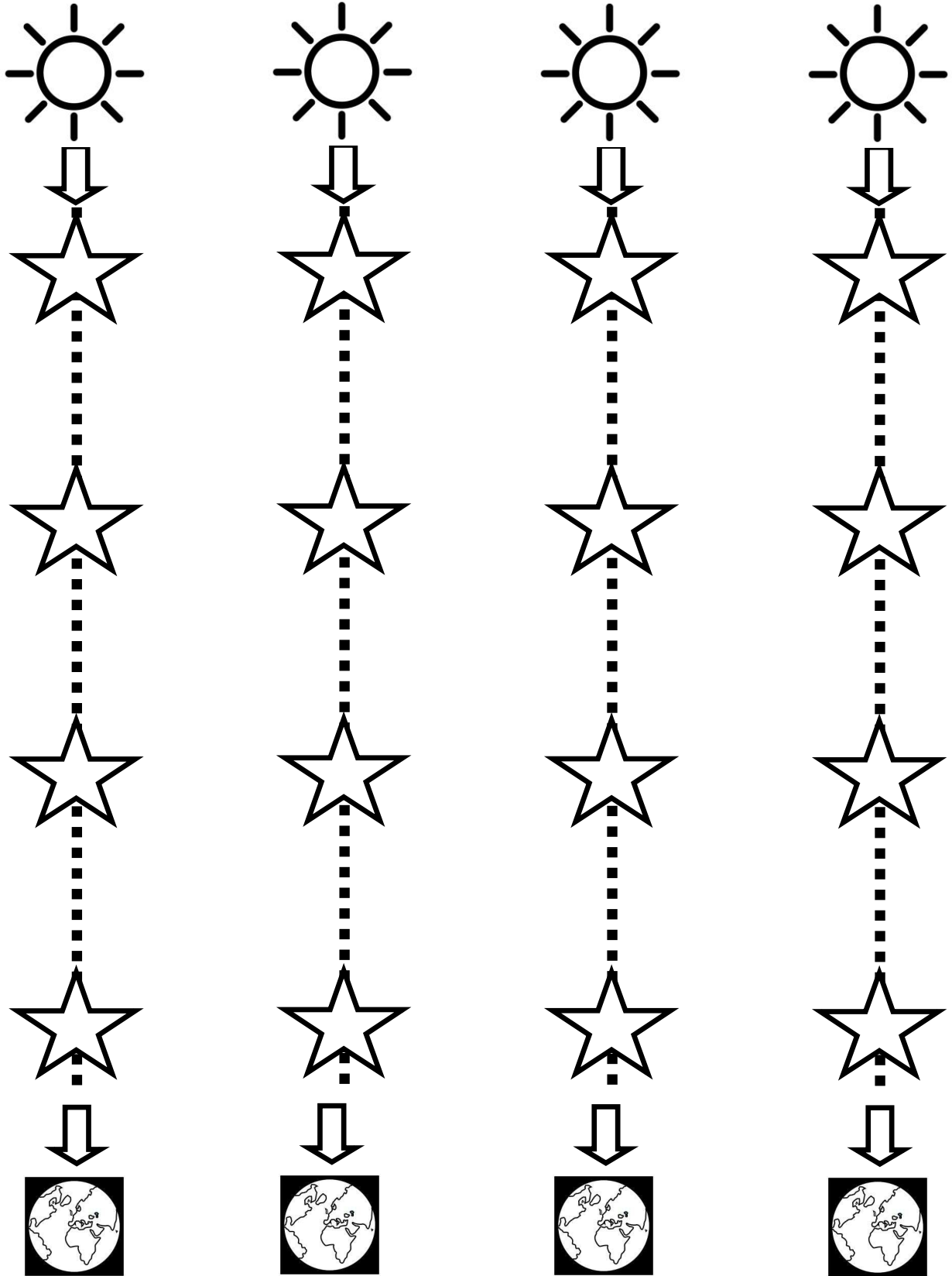

Actividades para mejorar motricidad fina

Sigue con tu lápiz las estrellitas para ir desde el sol a la tierra

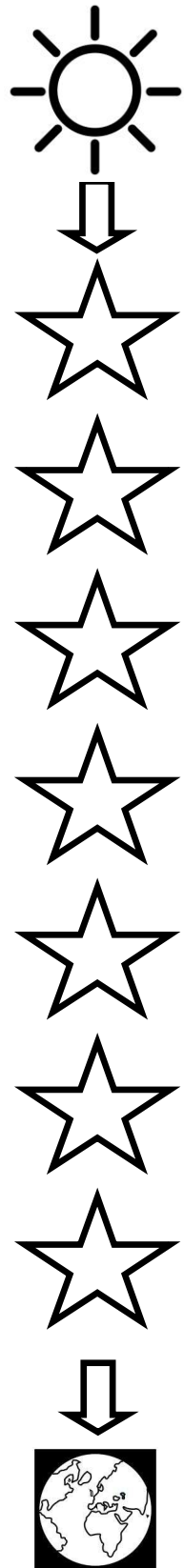
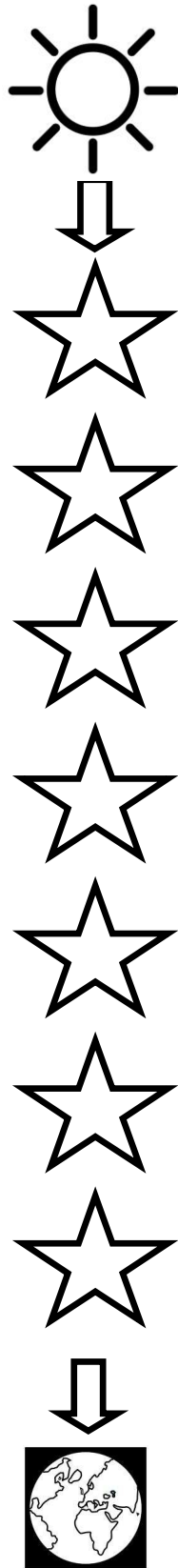
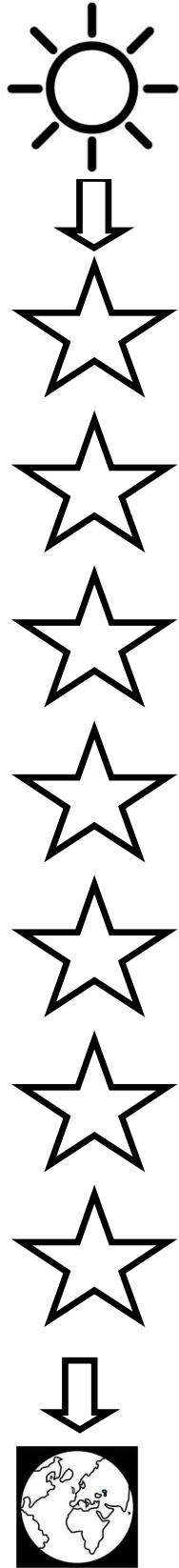
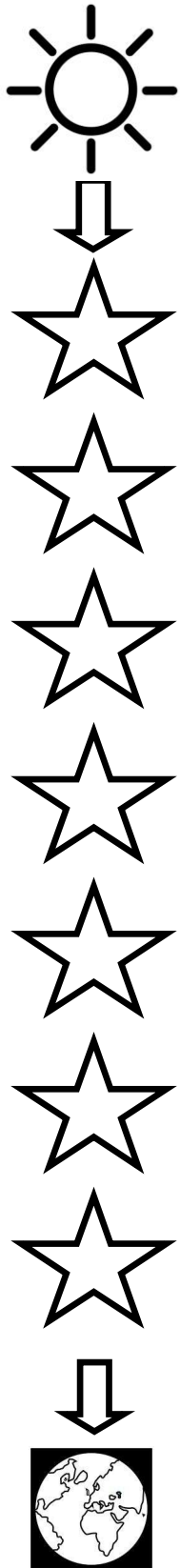

Actividades para mejorar motricidad fina

Sigue con tu lápiz las estrellitas para ir desde el sol a la tierra

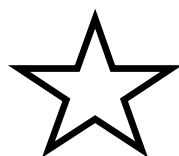
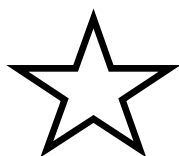
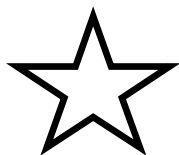
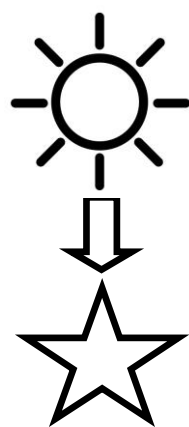
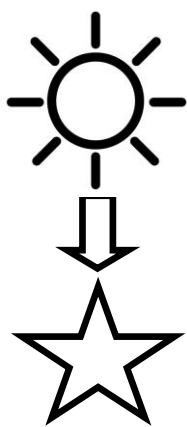
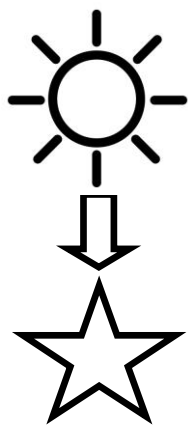
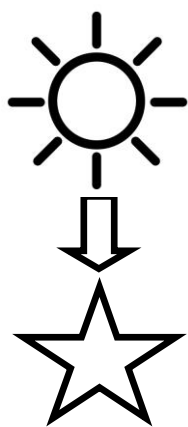

Actividades para mejorar motricidad fina

Sigue con tu lápiz los corazones para unir a la mama y a su bebe

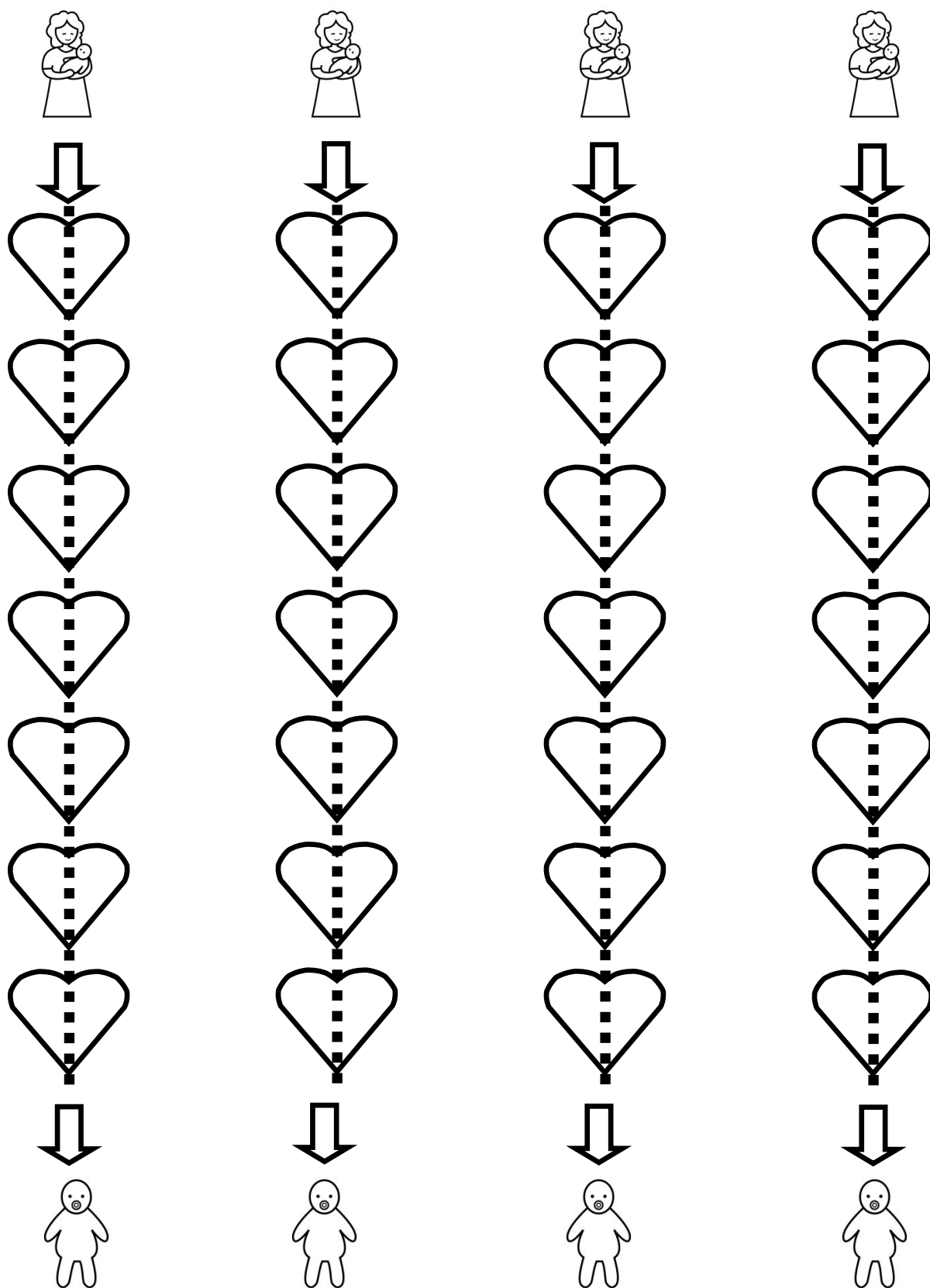

Actividades para mejorar motricidad fina

Sigue con tu lápiz los corazones para unir a la mama y a su bebe

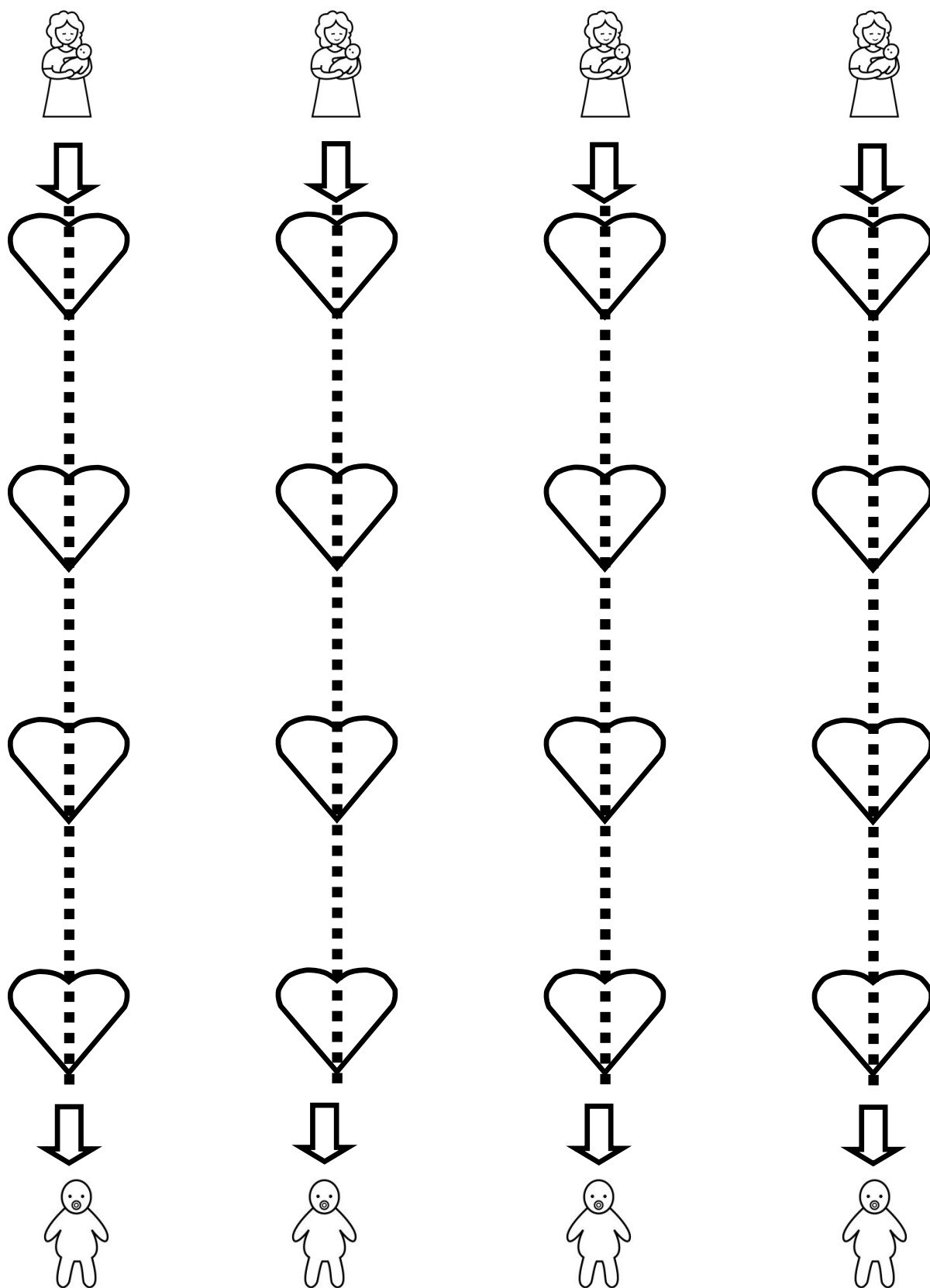

Actividades para mejorar motricidad fina

Sigue con tu lápiz los corazones para unir a la mama y a su bebe

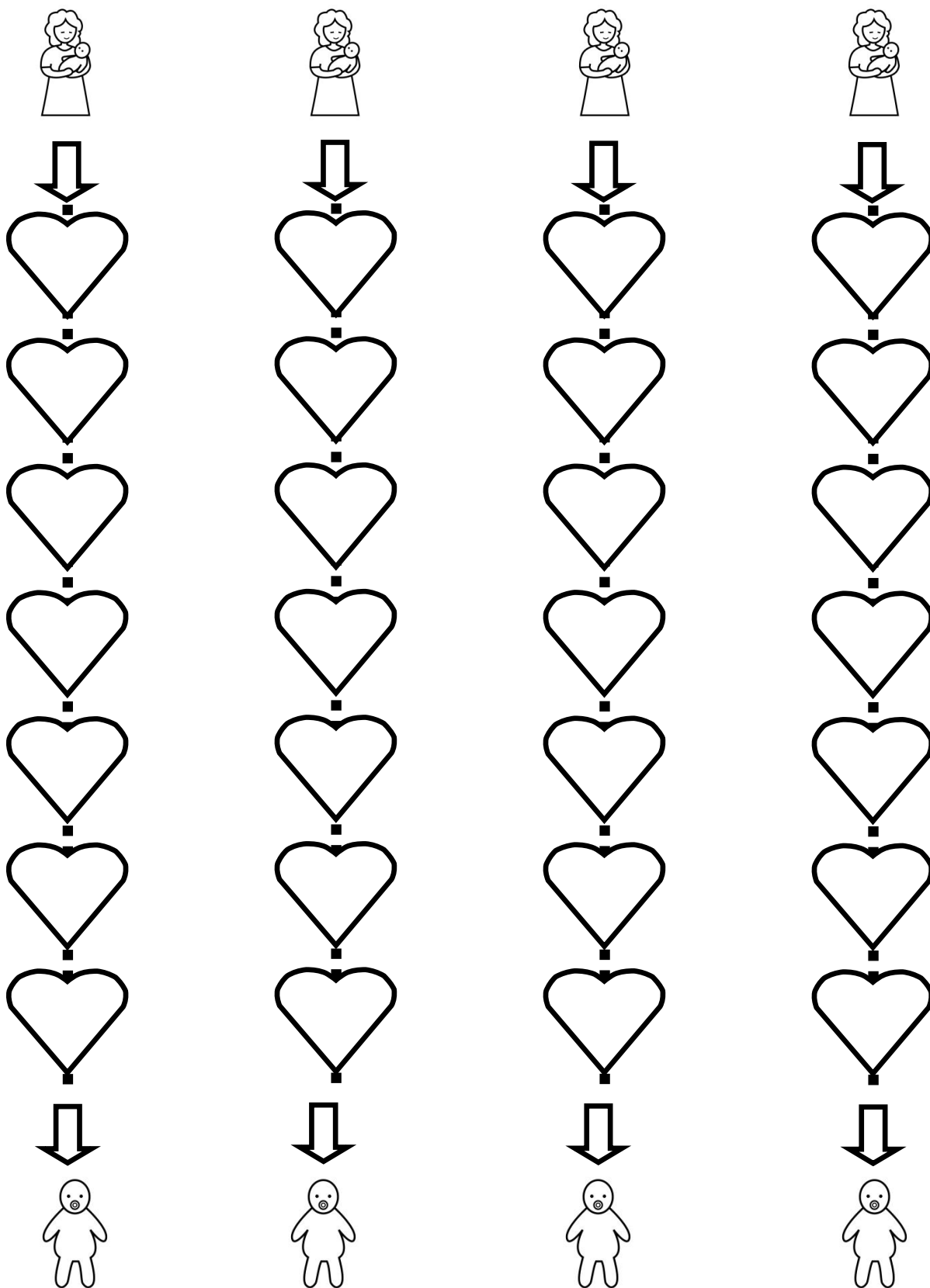

Actividades para mejorar motricidad fina

Sigue con tu lápiz los corazones para unir a la mama y a su bebe

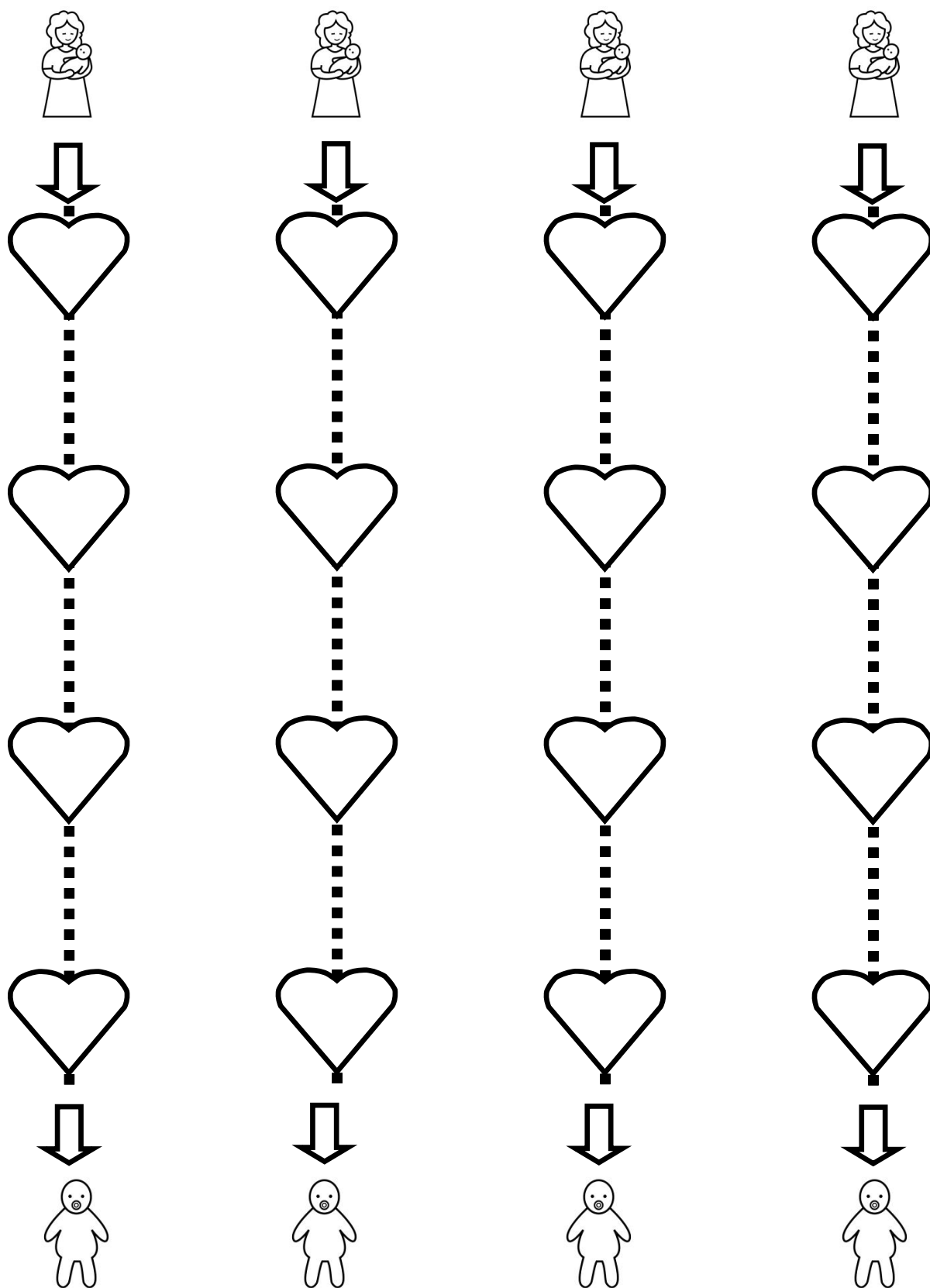

Actividades para mejorar motricidad fina

Sigue con tu lápiz los corazones para unir a la mama y a su bebe

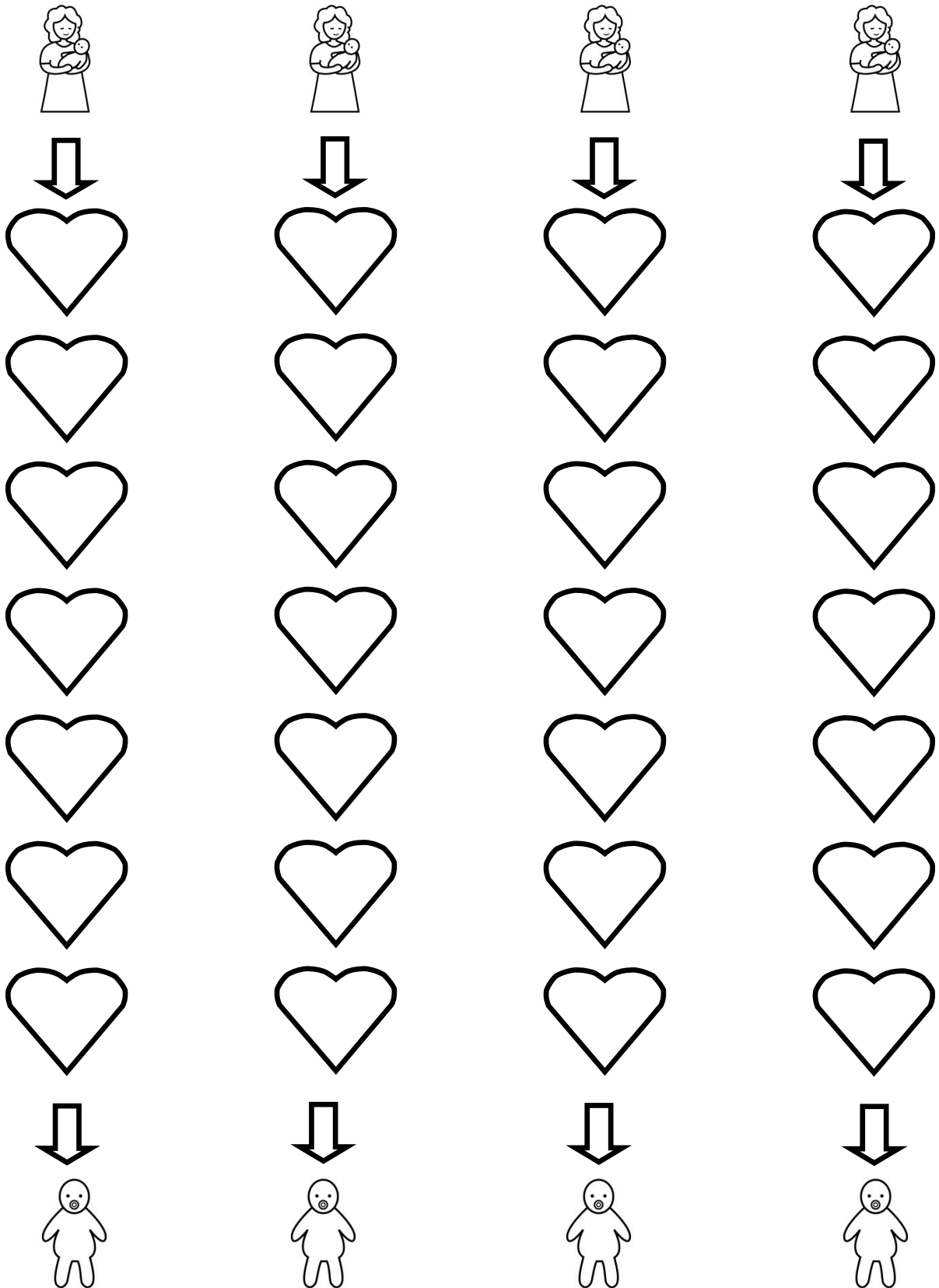

Actividades para mejorar motricidad fina

Sigue con tu lápiz los corazones para unir a la mama y a su bebe

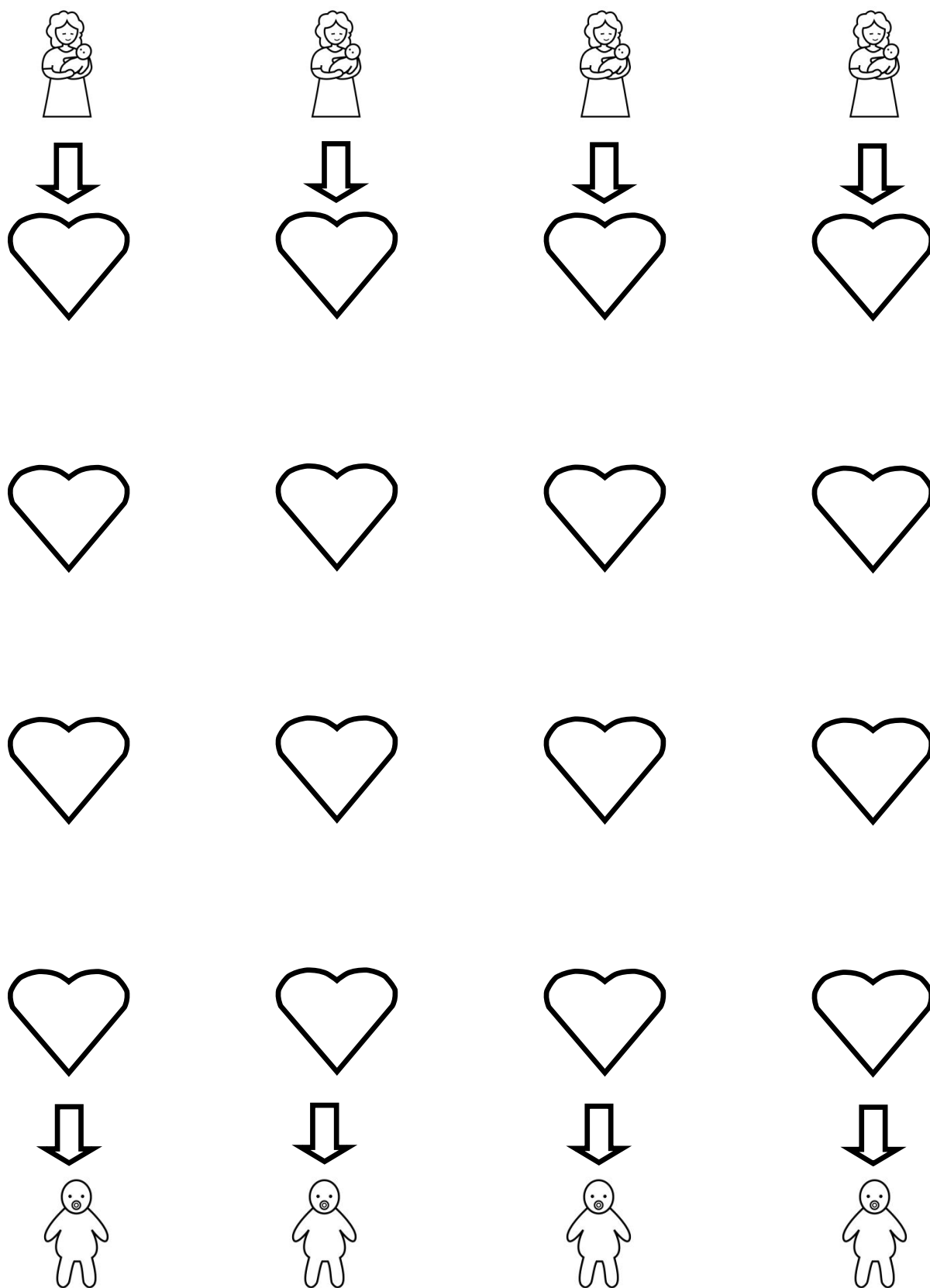

Actividades para mejorar motricidad fina

Sigue con tu lápiz las caras para unir al niño con su amiga

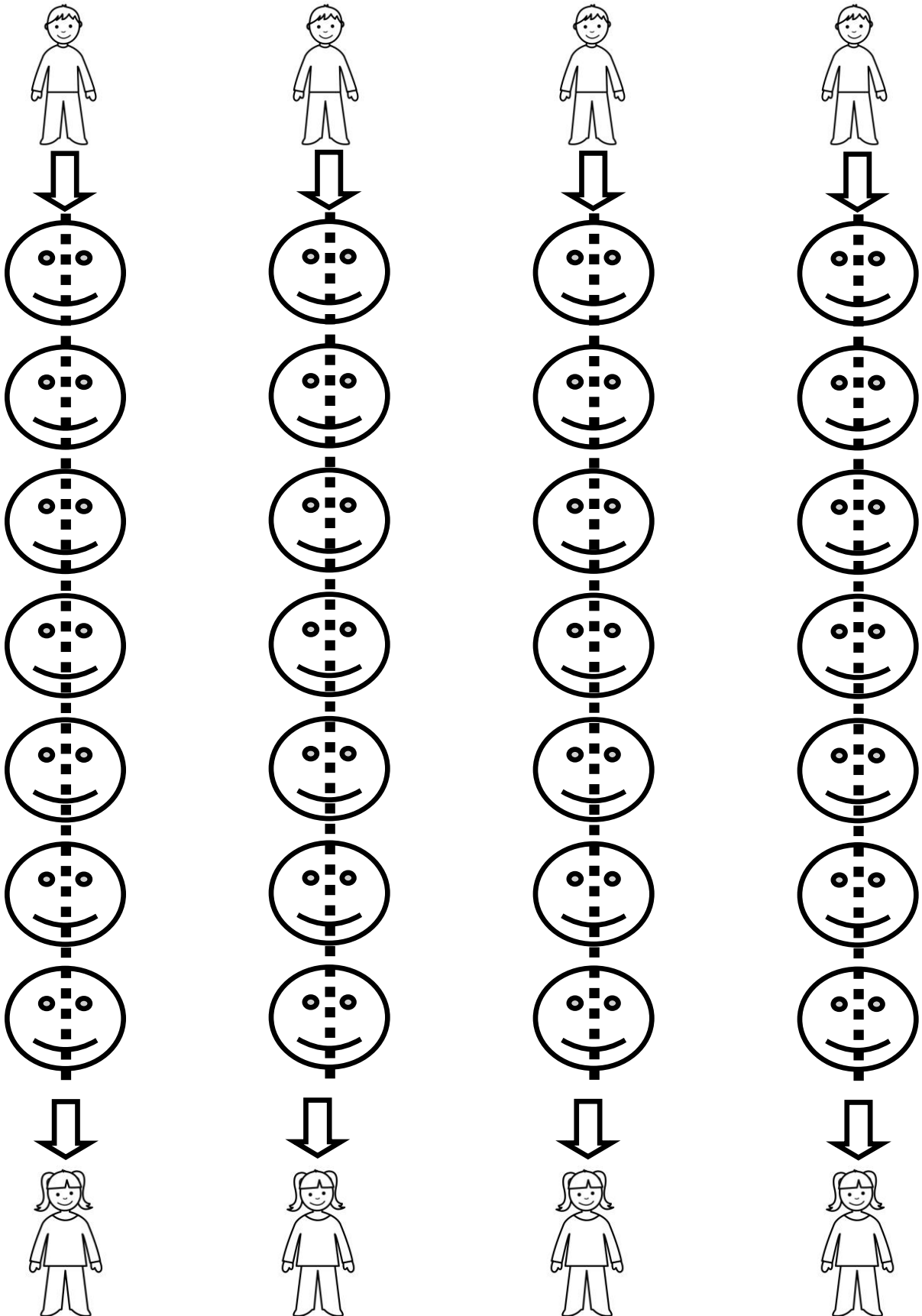

Actividades para mejorar motricidad fina

Sigue con tu lápiz caras para unir al niño con su amiga

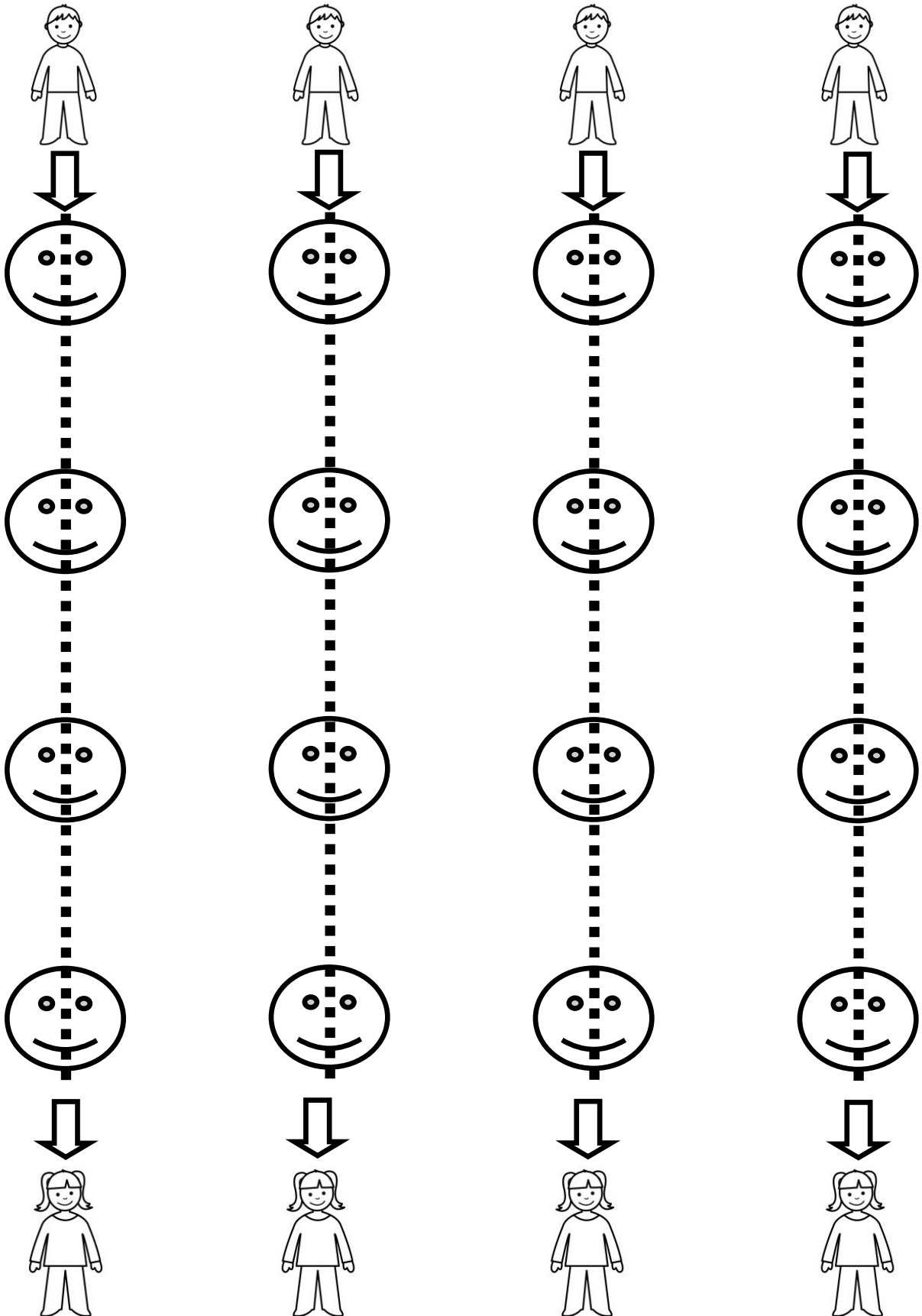

Actividades para mejorar motricidad fina

Sigue con tu lápiz caras para unir al niño con su amiga

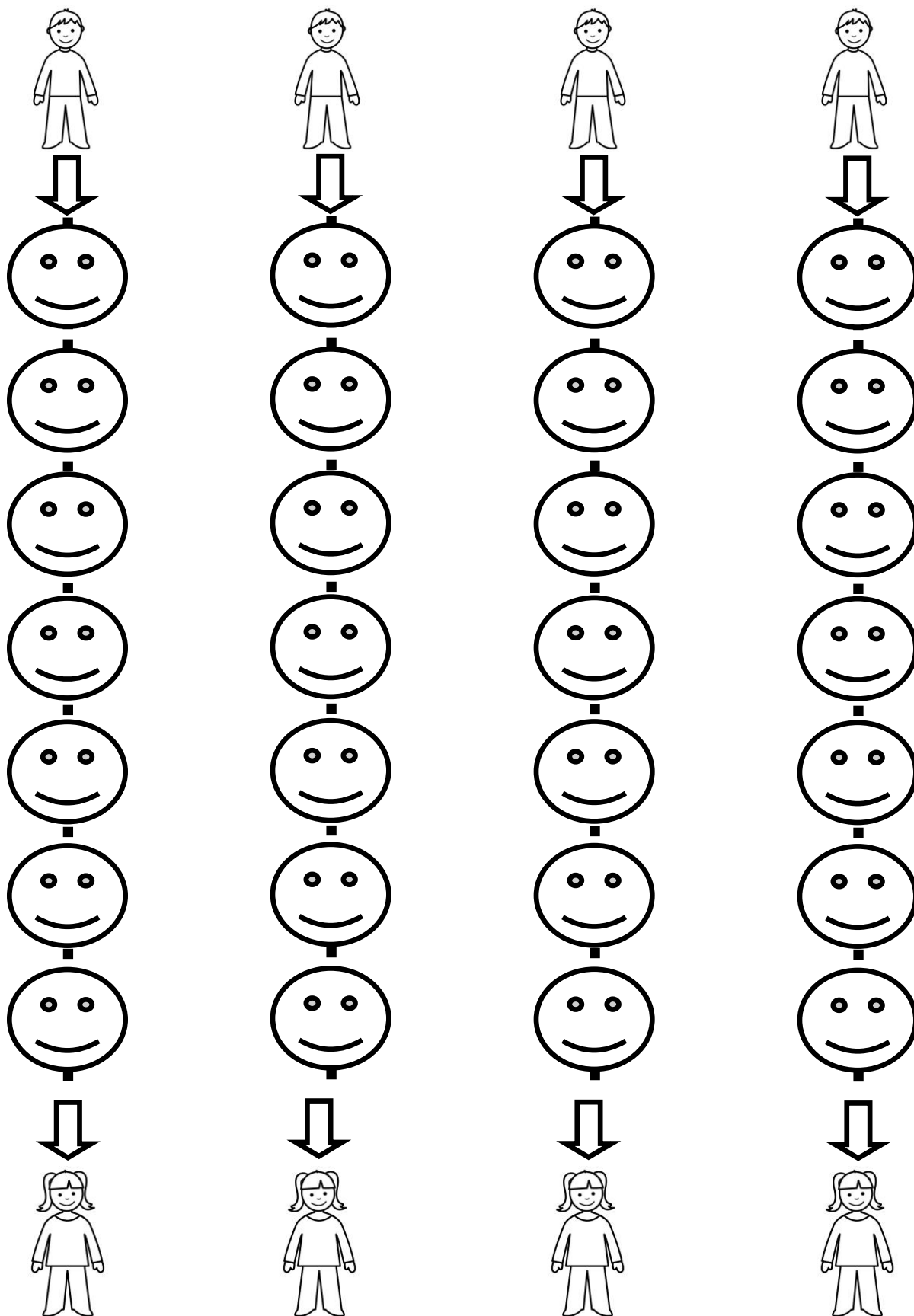

Actividades para mejorar motricidad fina

Sigue con tu lápiz caras para unir al niño con su amiga

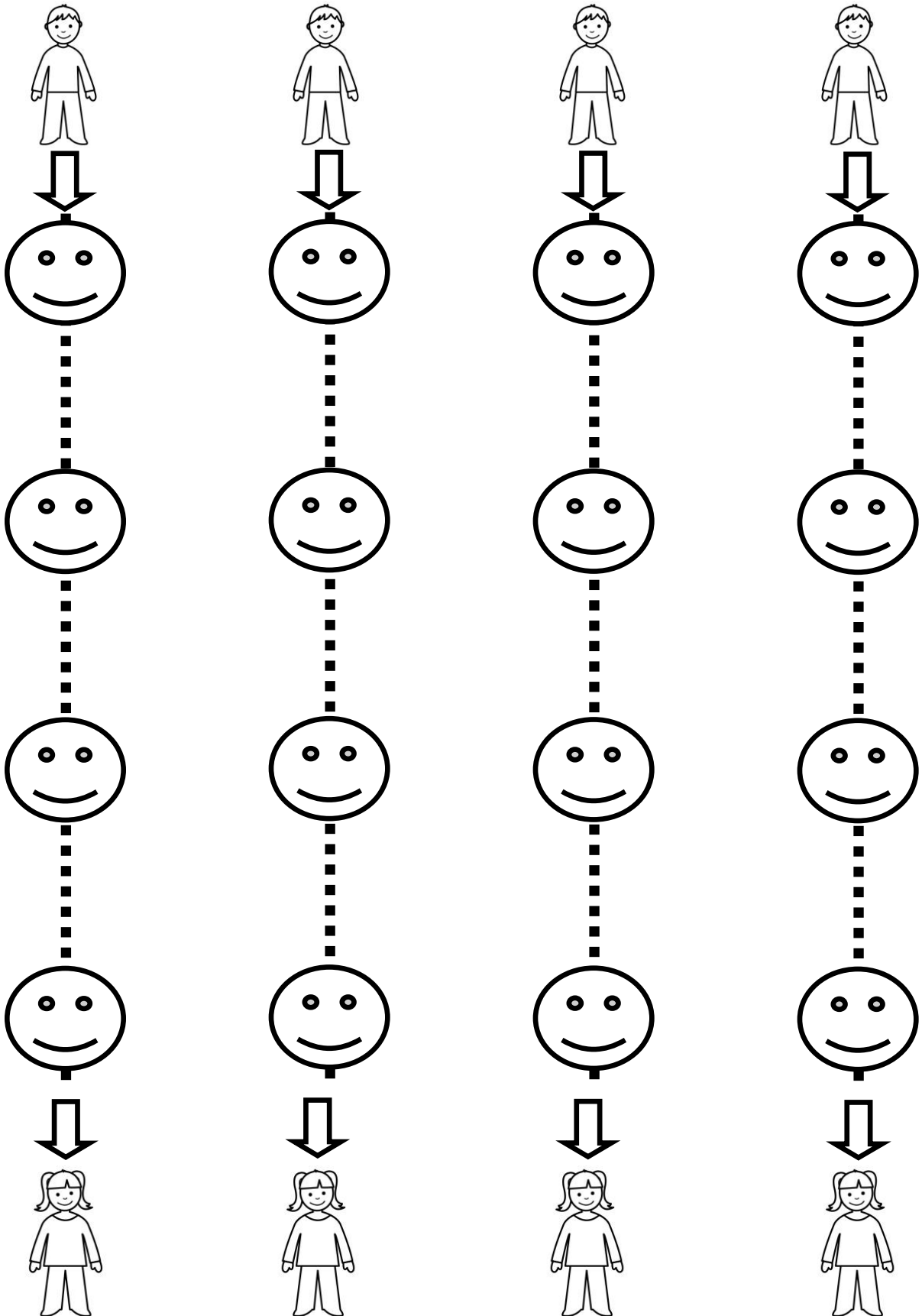

Actividades para mejorar motricidad fina

Sigue con tu lápiz caras para unir al niño con su amiga

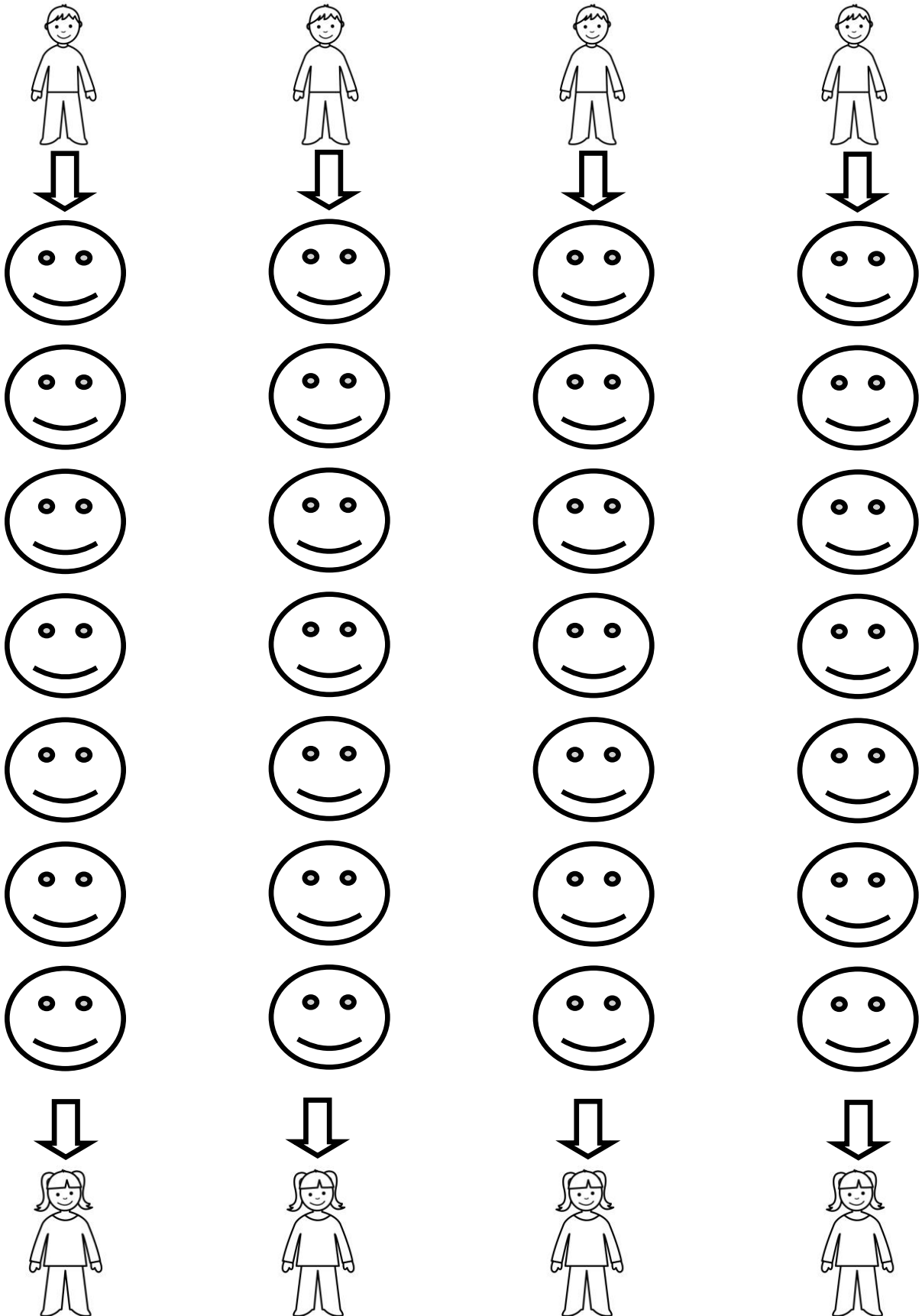

Actividades para mejorar motricidad fina

Sigue con tu lápiz caras para unir al niño con su amiga

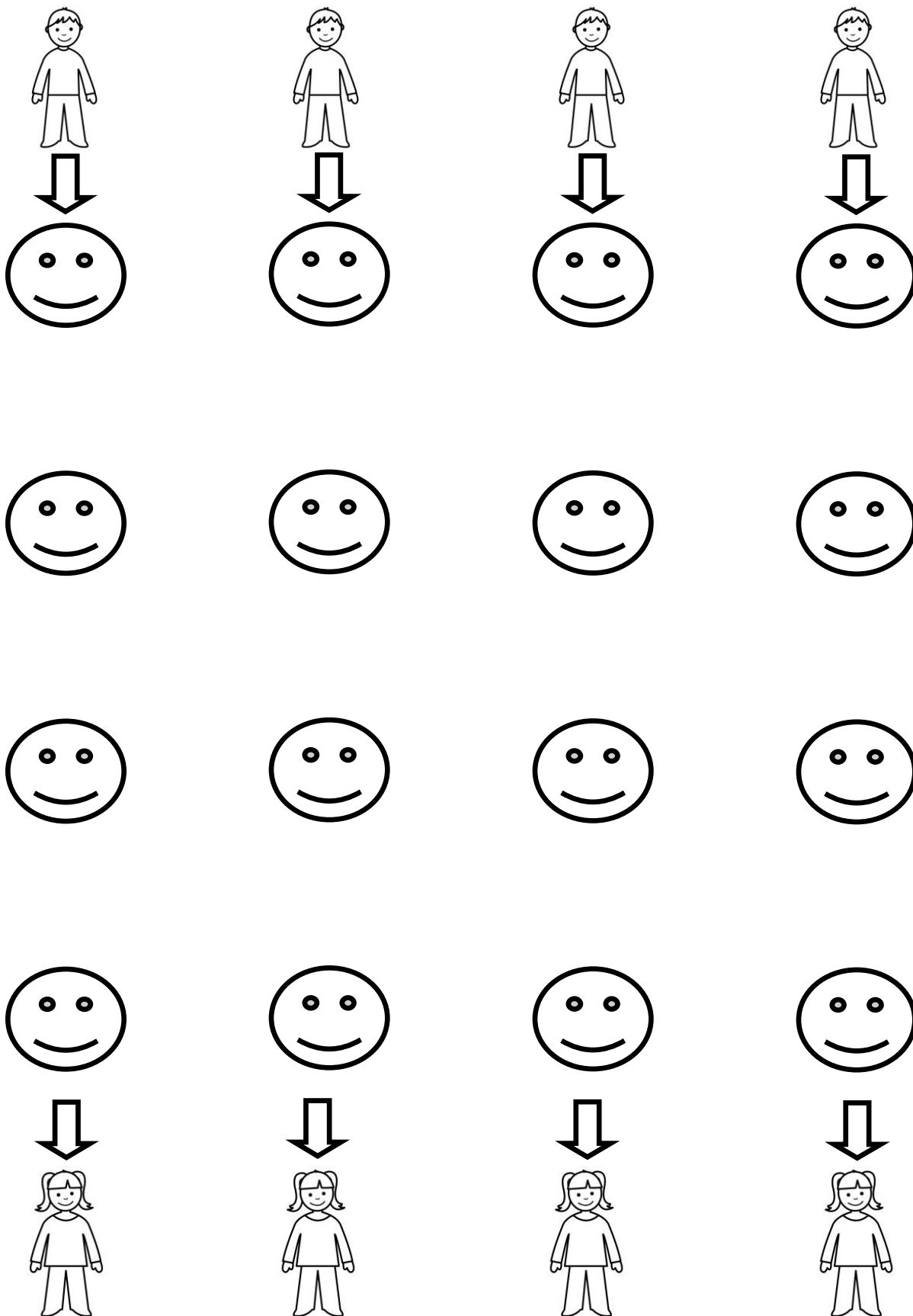

Actividades para mejorar motricidad fina

Sigue con tu lápiz los círculos para unir al niño con su balón

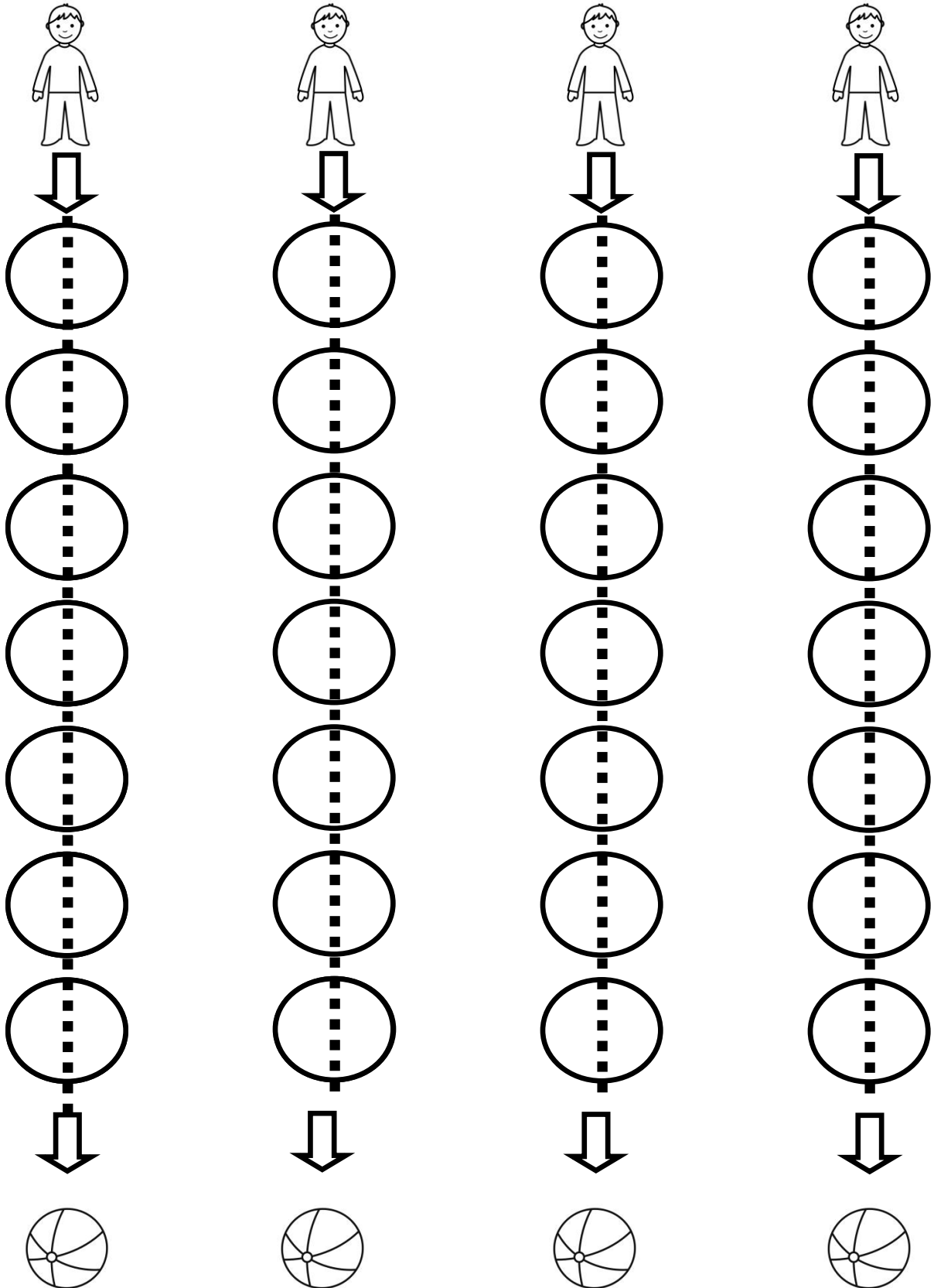

Actividades para mejorar motricidad fina

Sigue con tu lápiz los círculos para unir al niño con su balón

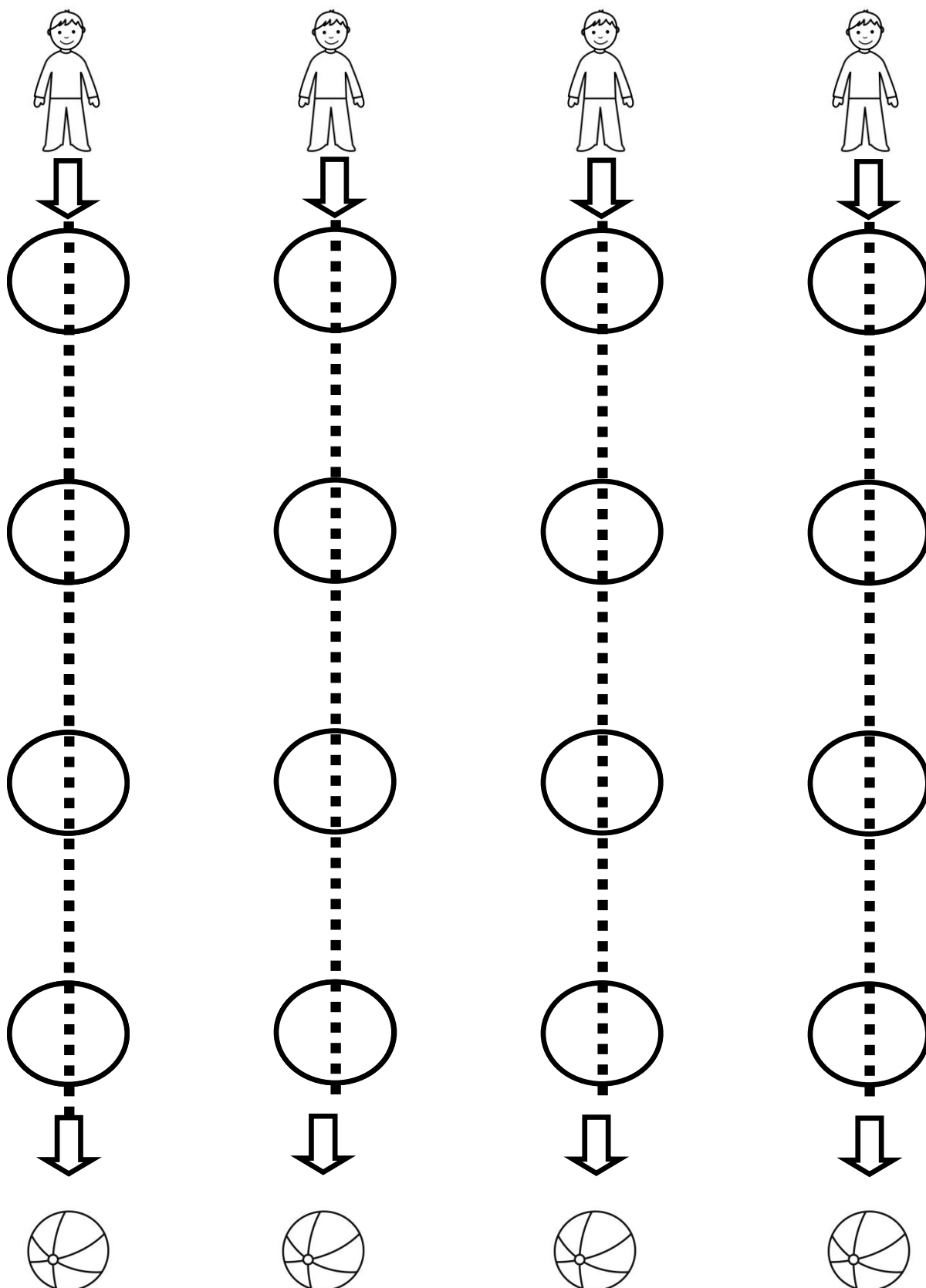

Actividades para mejorar motricidad fina

Sigue con tu lápiz los círculos para unir al niño con su balón

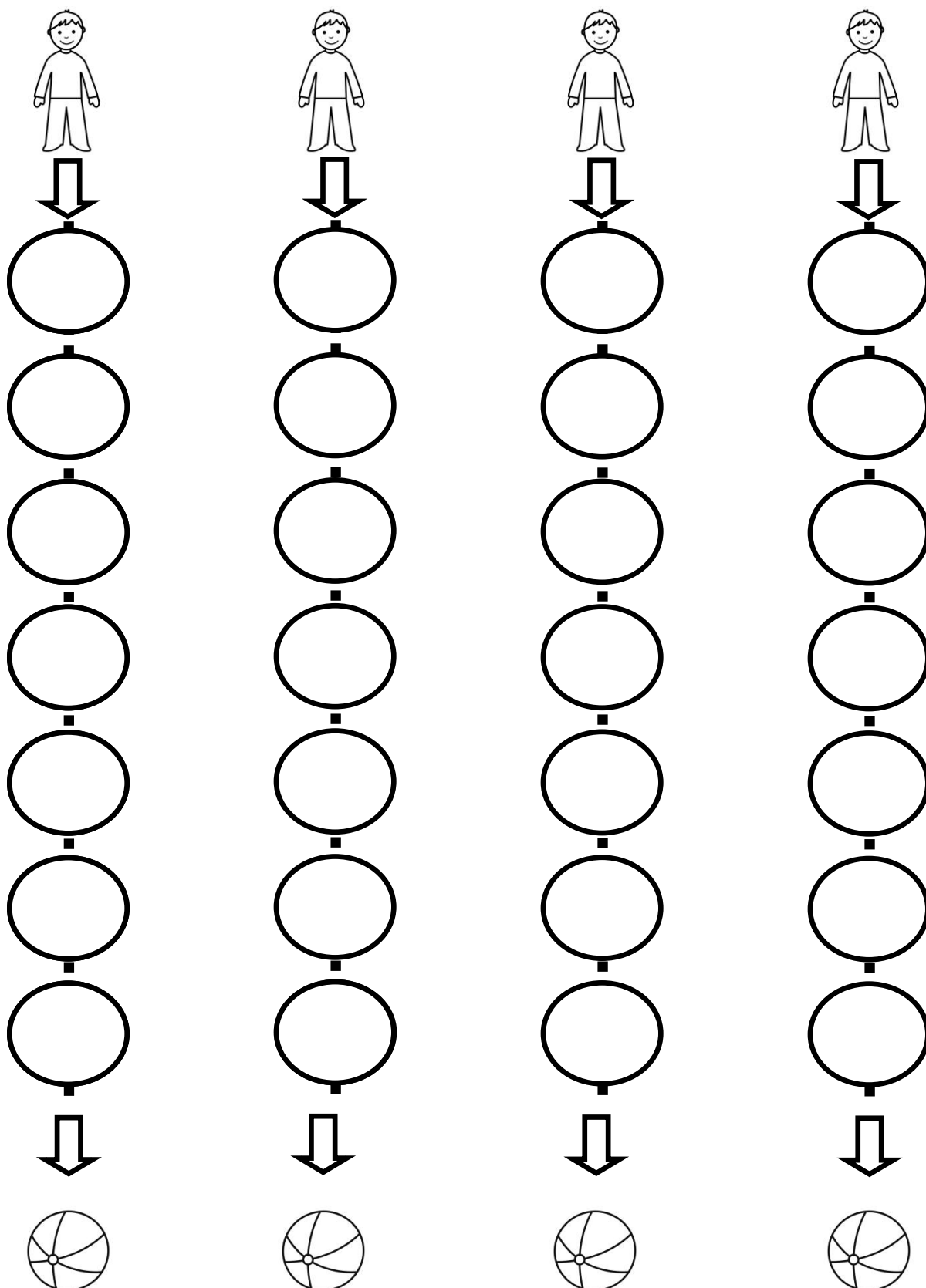

Actividades para mejorar motricidad fina

Sigue con tu lápiz los círculos para unir al niño con su balón

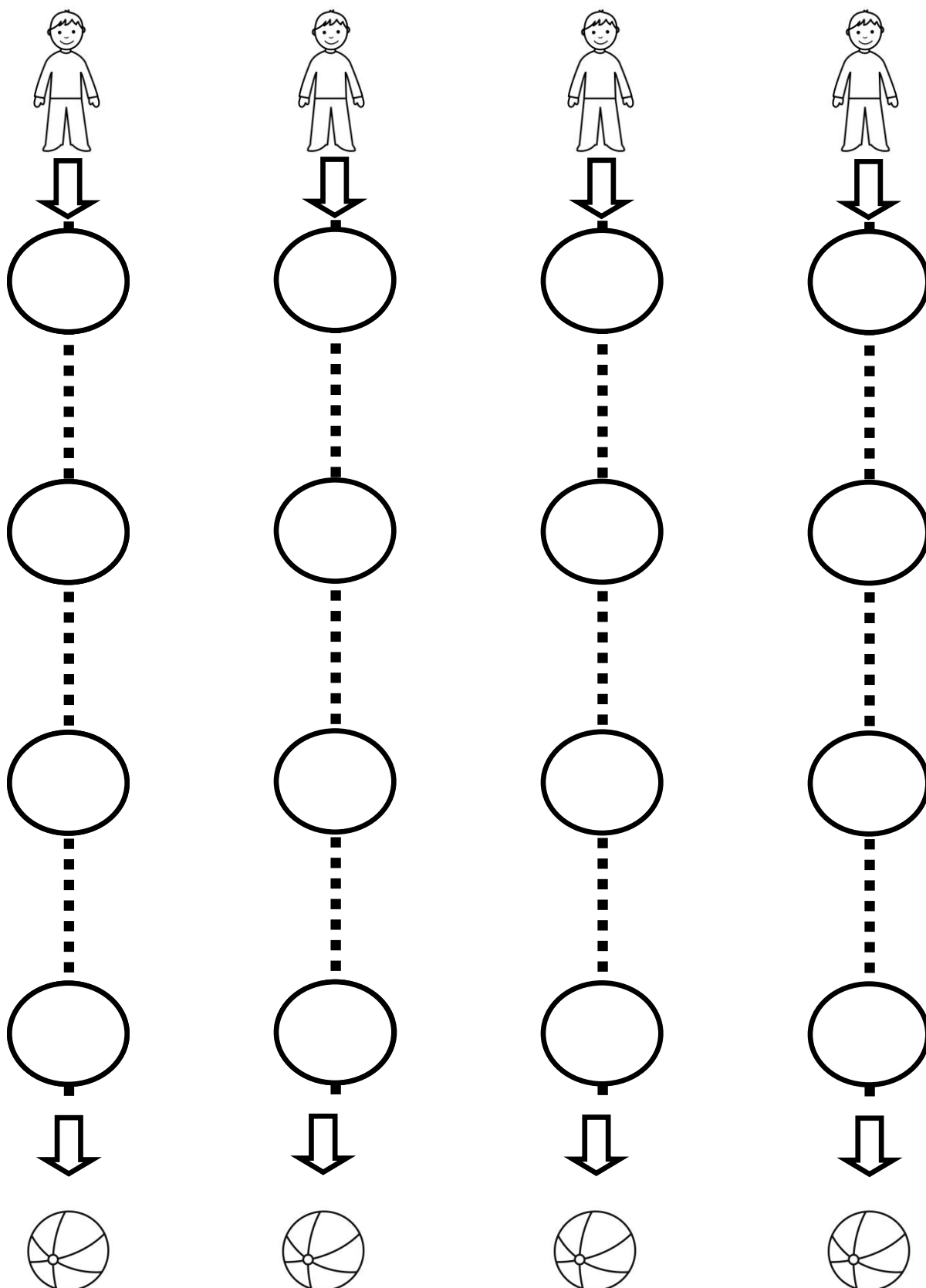

Actividades para mejorar motricidad fina

Sigue con tu lápiz los círculos para unir al niño con su balón

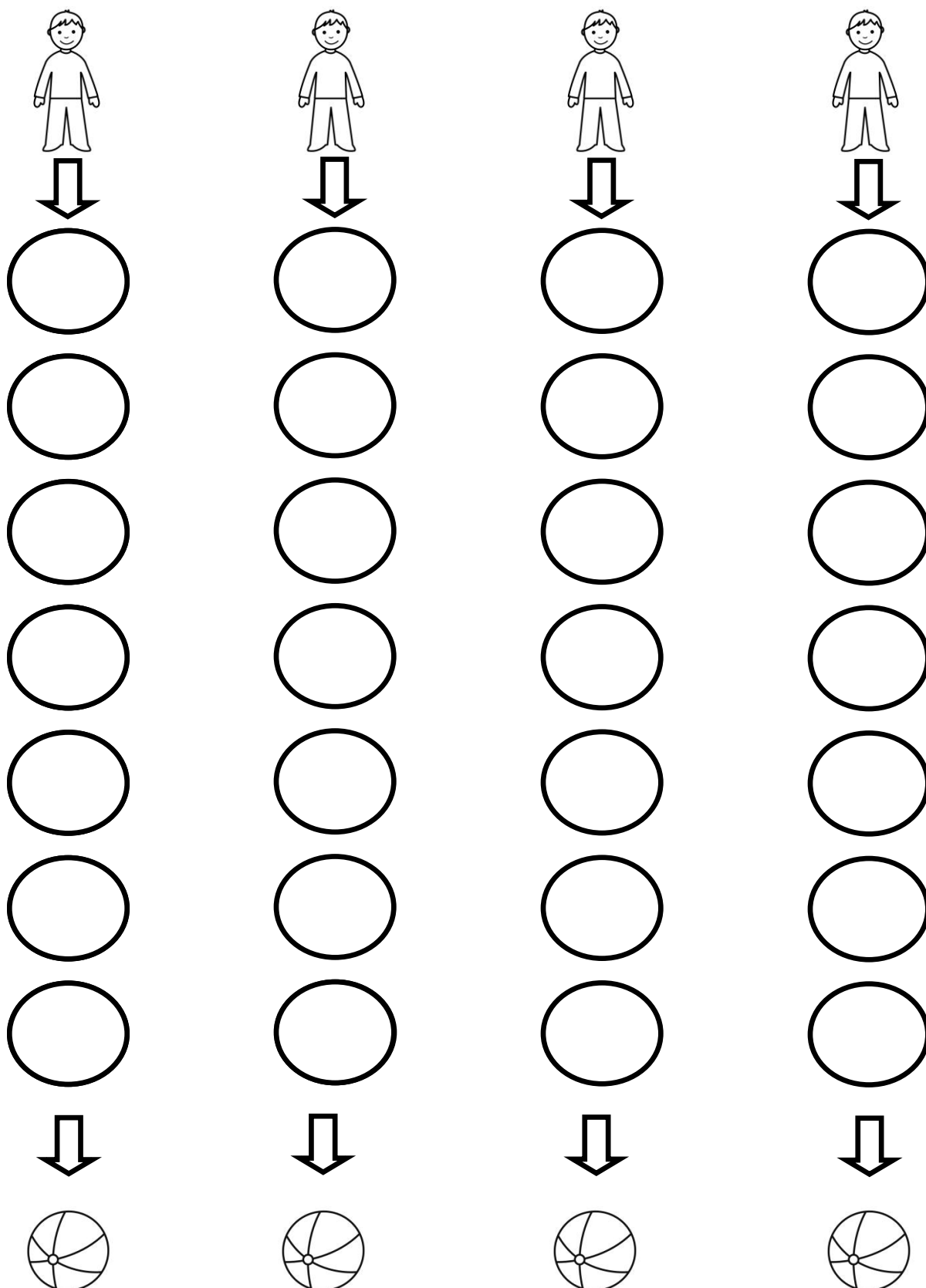

Actividades para mejorar motricidad fina

Sigue con tu lápiz los círculos para unir al niño con su balón

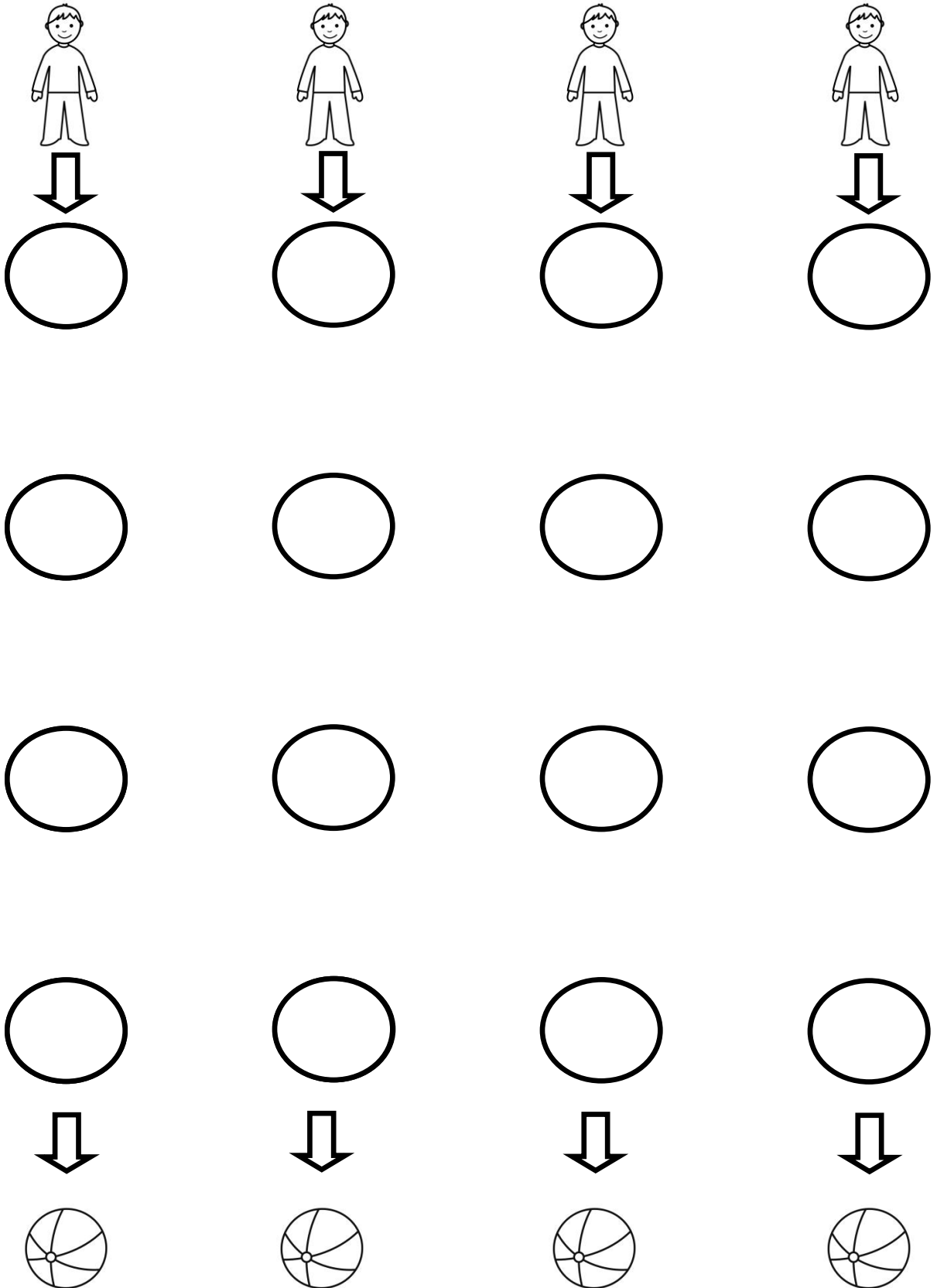

Actividades para mejorar motricidad fina

Sigue con tu lápiz los rayos para unir a nube y la tierra

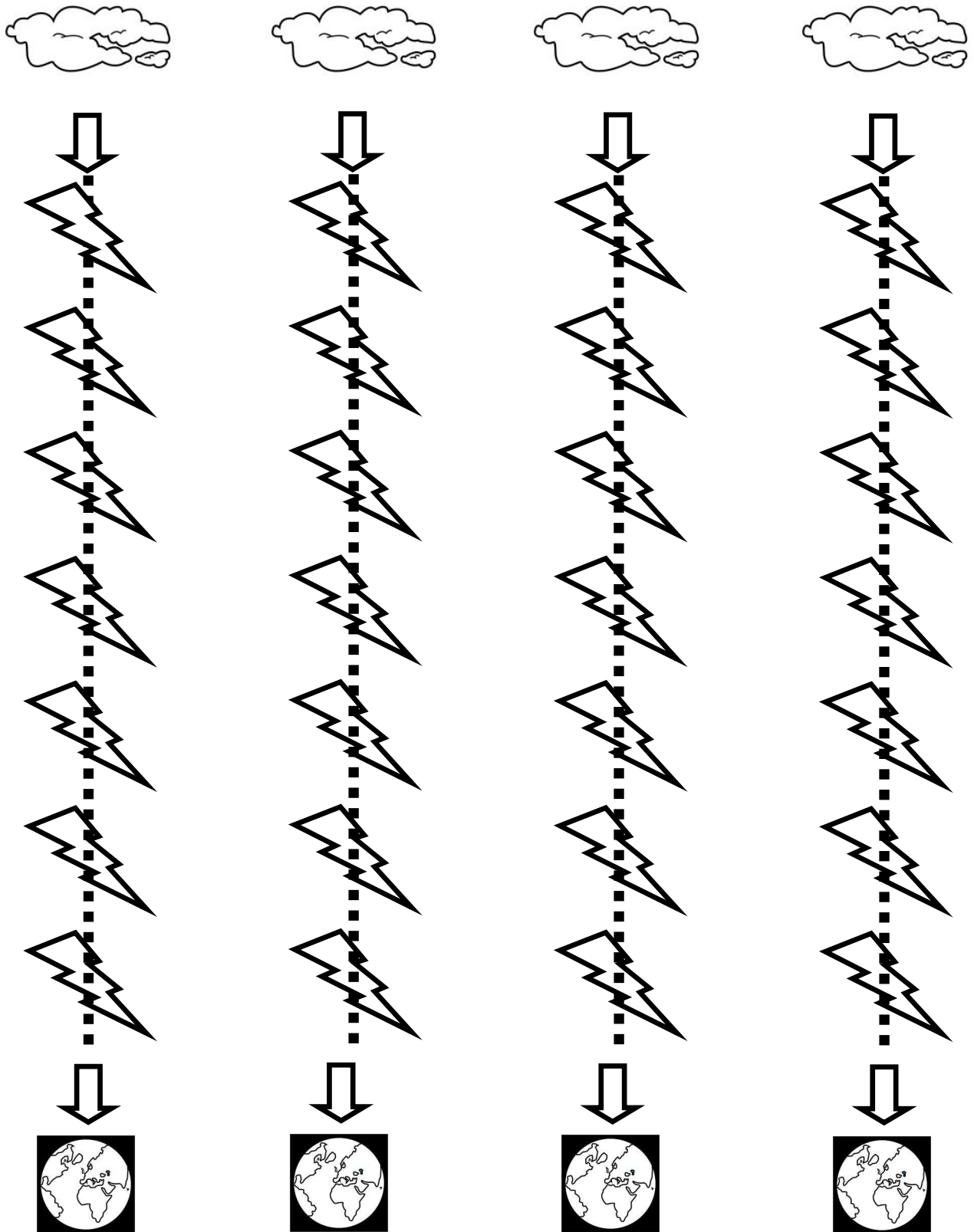

Actividades para mejorar motricidad fina

Sigue con tu lápiz los rayos para unir a nube y la tierra

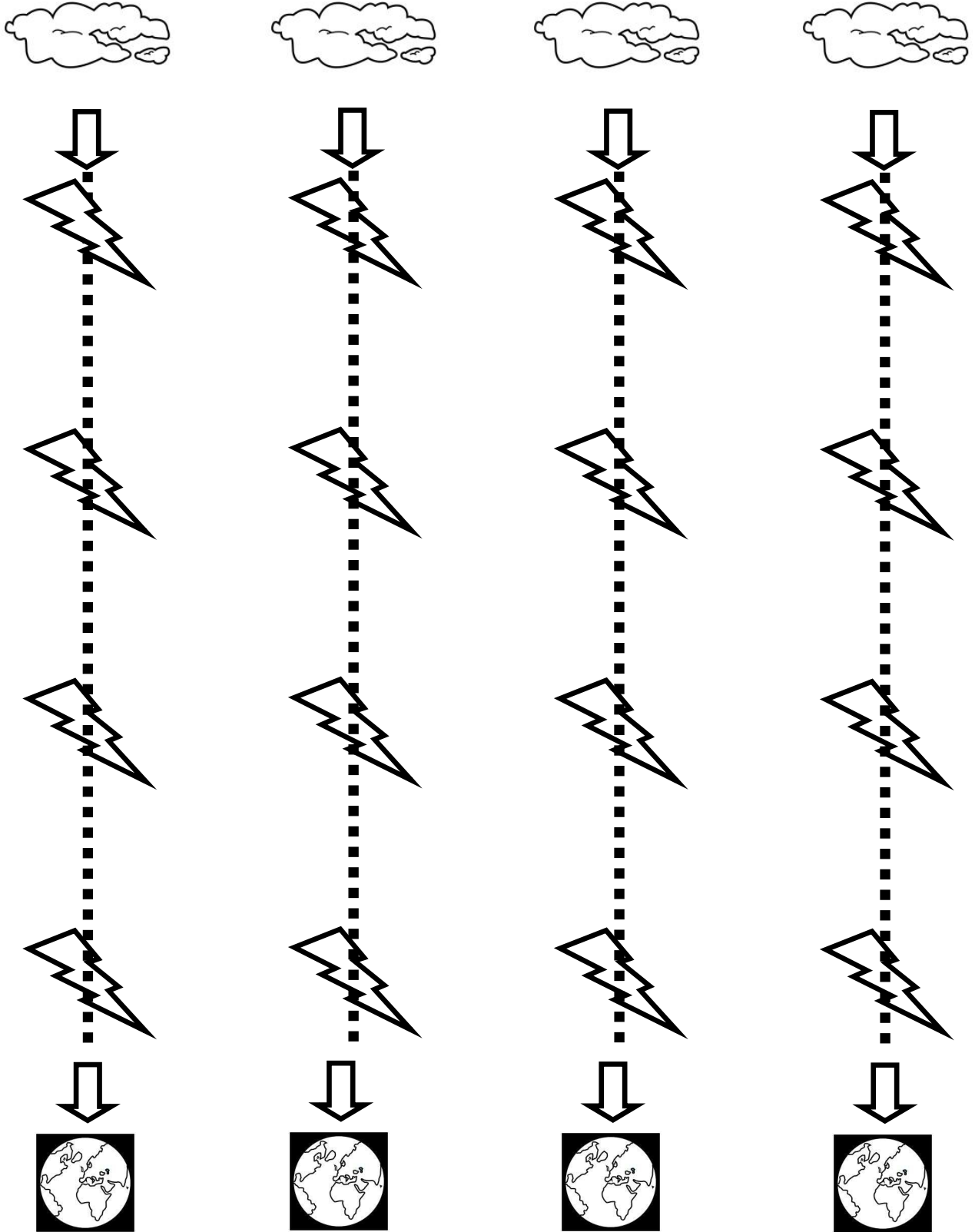

Actividades para mejorar motricidad fina

Sigue con tu lápiz los rayos para unir a nube y la tierra

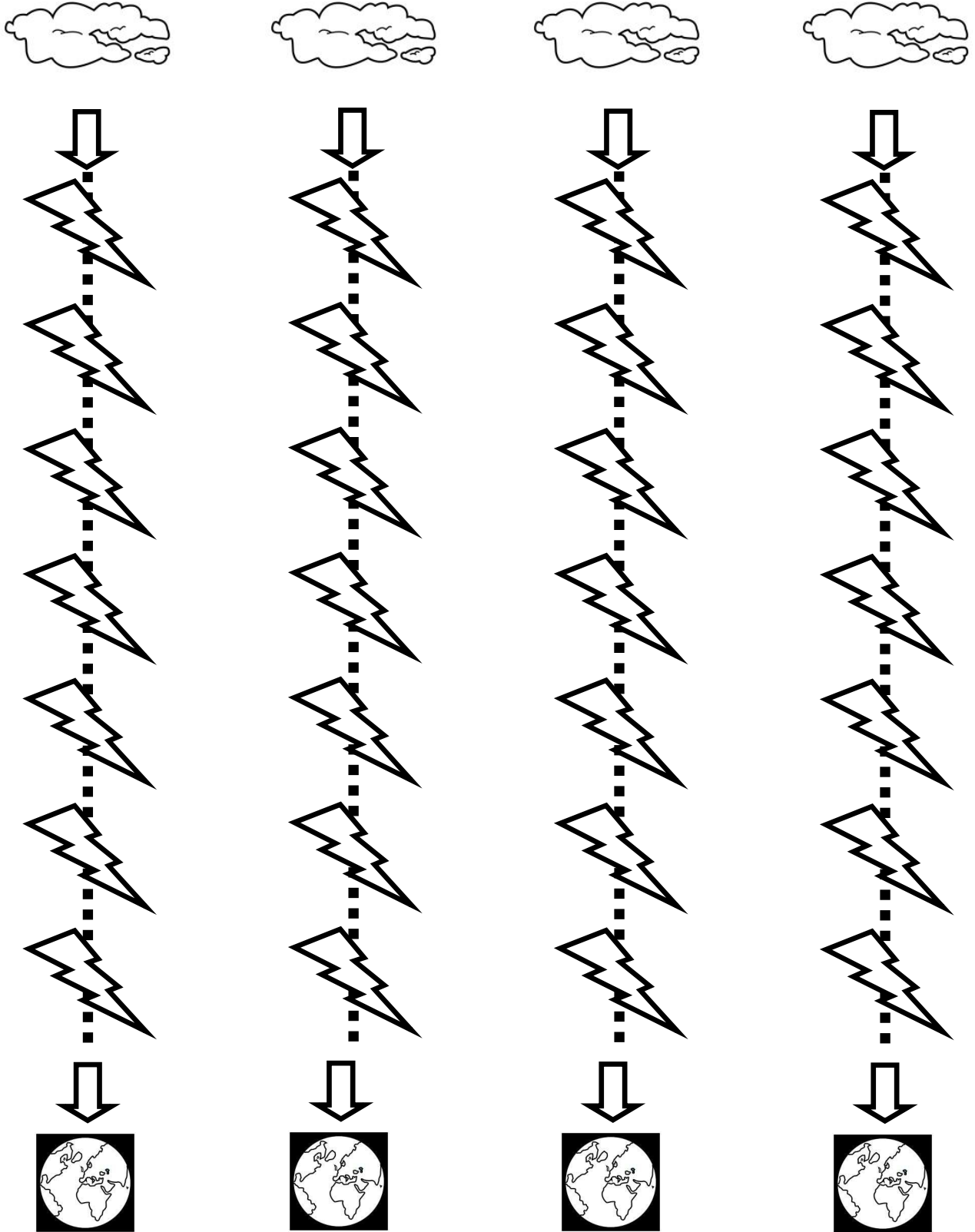

Actividades para mejorar motricidad fina

Sigue con tu lápiz los rayos para unir a nube y la tierra

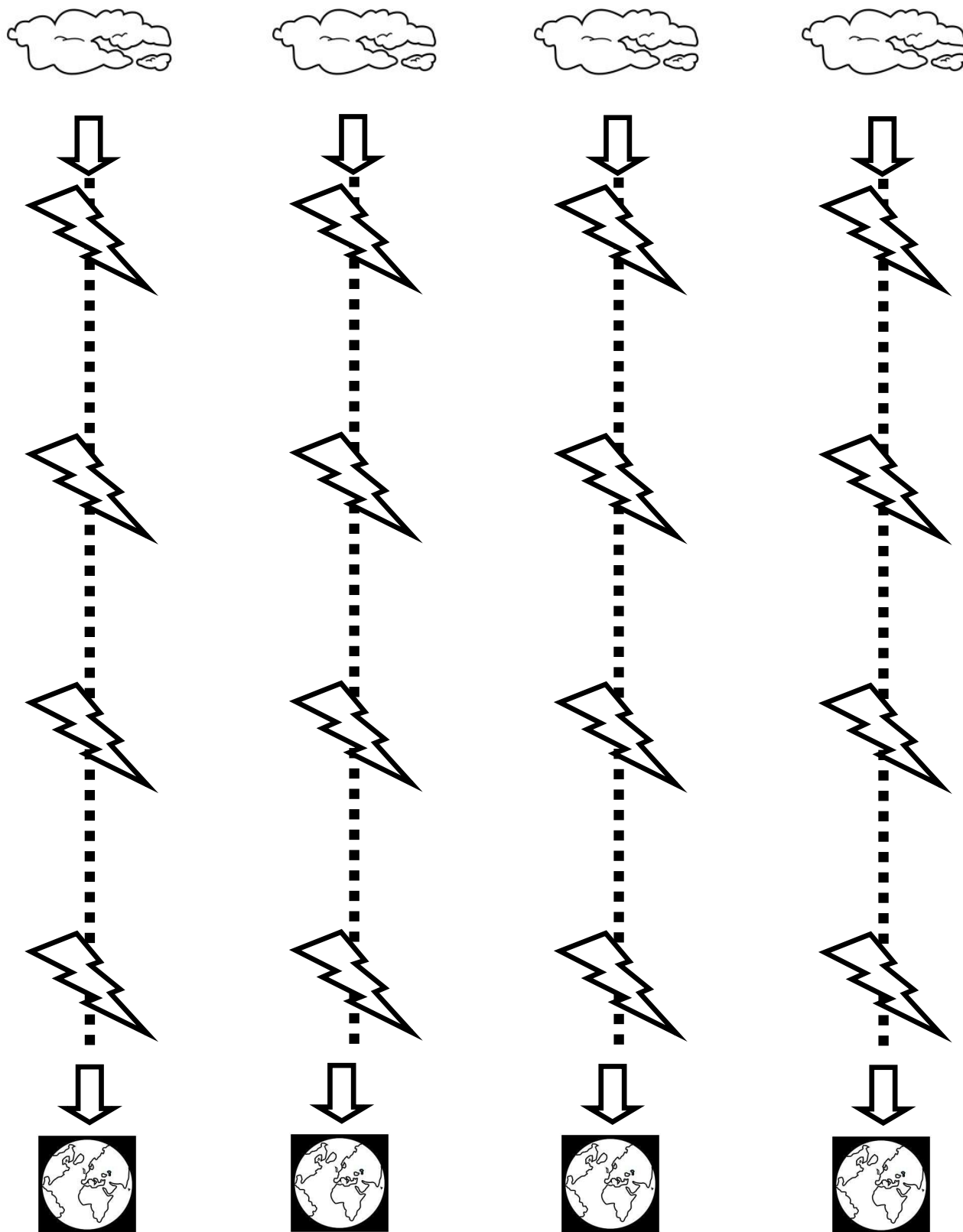

Actividades para mejorar motricidad fina

Sigue con tu lápiz los rayos para unir a nube y la tierra

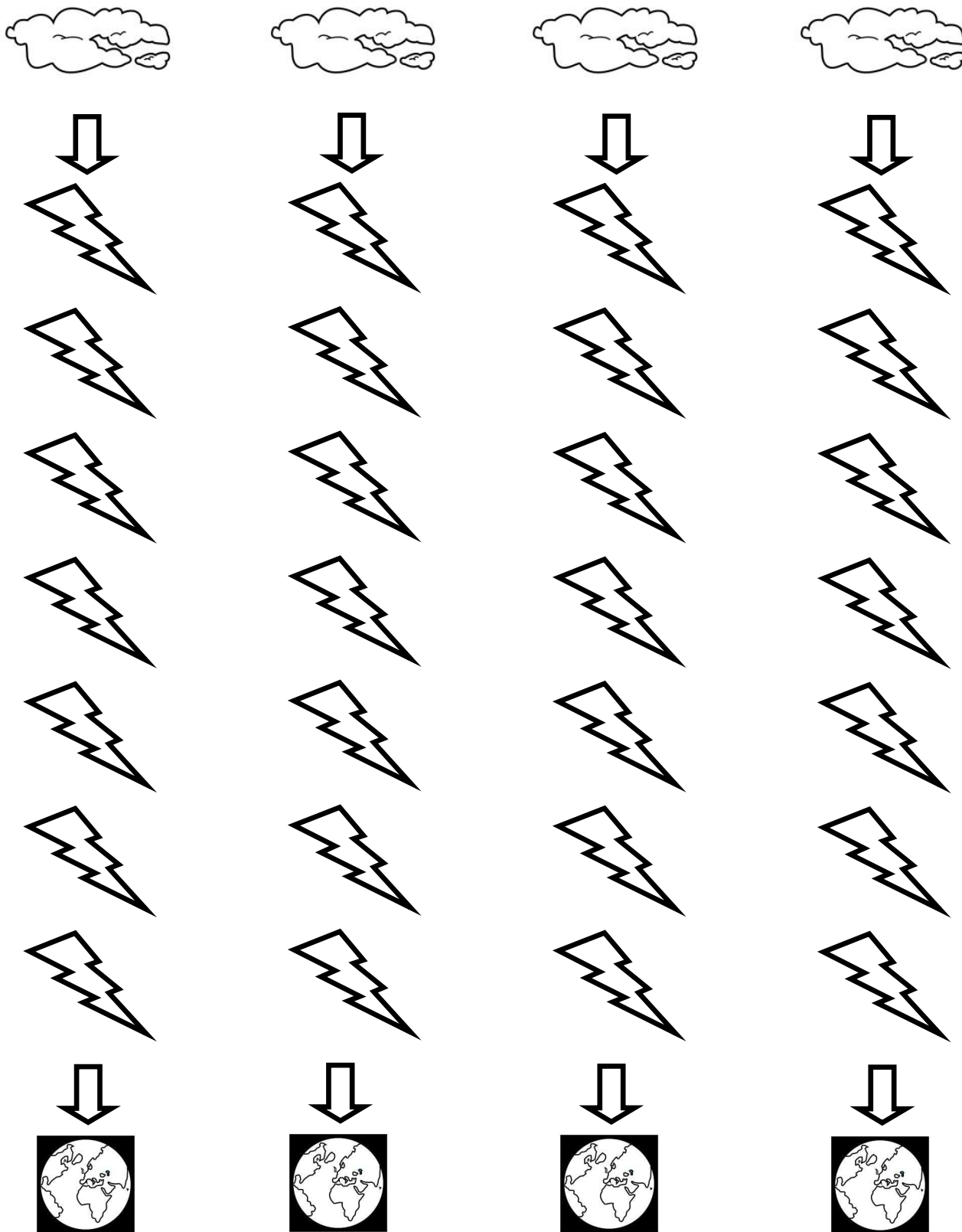

Actividades para mejorar motricidad fina

Sigue con tu lápiz los rayos para unir a nube y la tierra

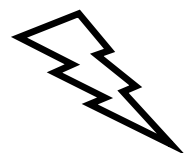
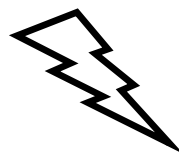
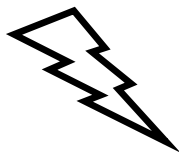
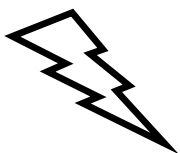
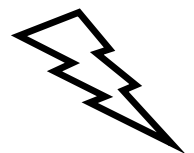
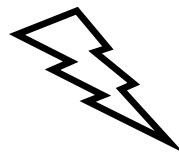
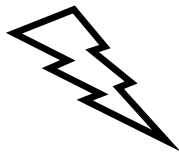
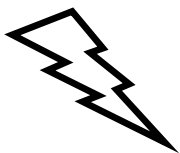
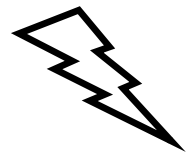
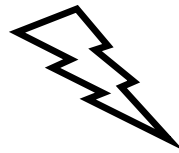
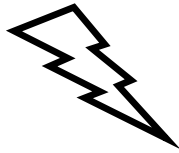
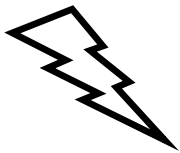
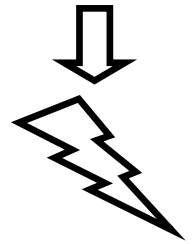
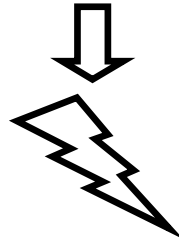
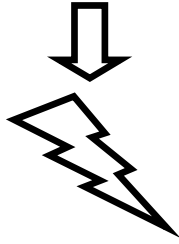
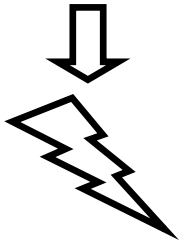

Actividades para mejorar motricidad fina

Sigue con tu lápiz las estrellitas para ir desde el sol a la tierra



Actividades para mejorar motricidad fina

Sigue con tu lápiz las estrellitas para ir desde el sol a la tierra



Actividades para mejorar motricidad fina

Sigue con tu lápiz las estrellitas para ir desde el sol a la tierra



Actividades para mejorar motricidad fina

Sigue con tu lápiz las estrellitas para ir desde el sol a la tierra

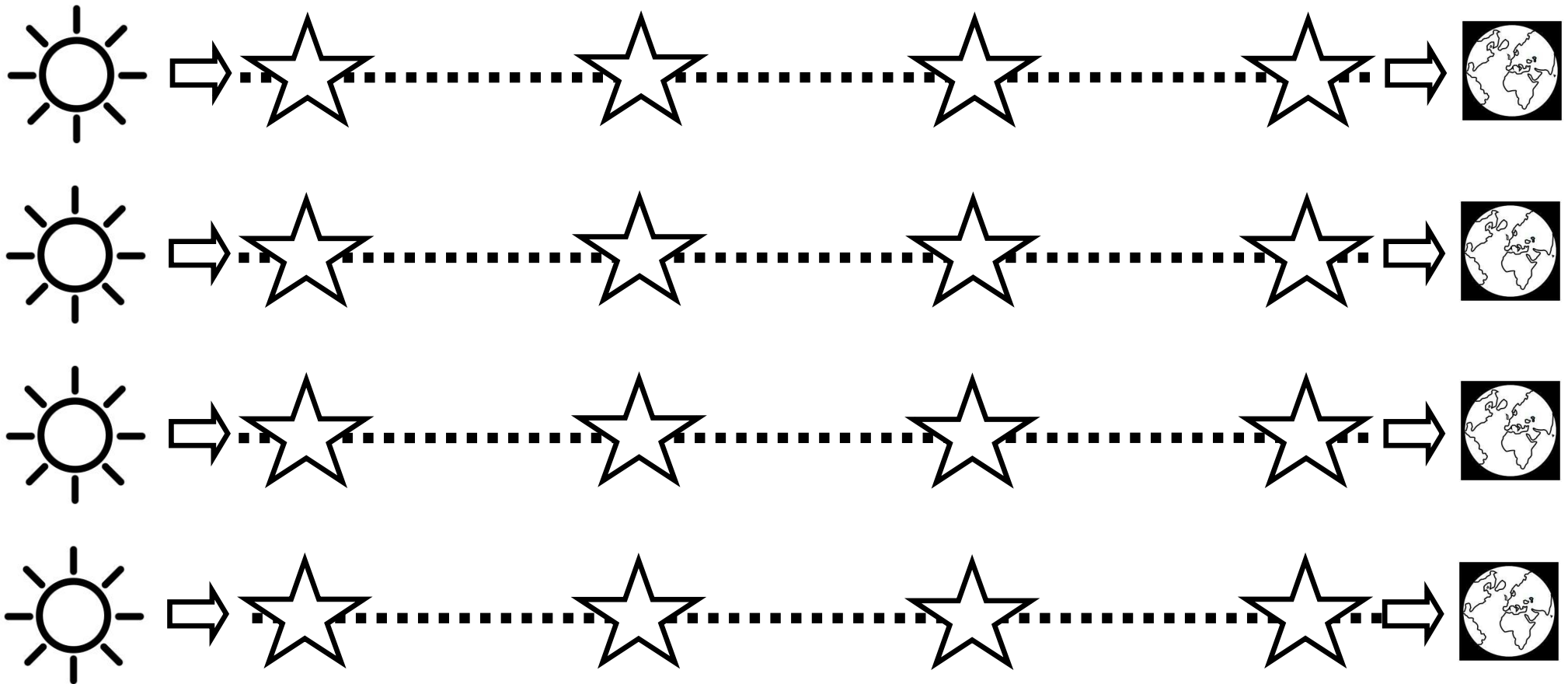

Actividades para mejorar motricidad fina

Sigue con tu lápiz las estrellitas para ir desde el sol a la tierra



Actividades para mejorar motricidad fina

Sigue con tu lápiz las estrellitas para ir desde el sol a la tierra

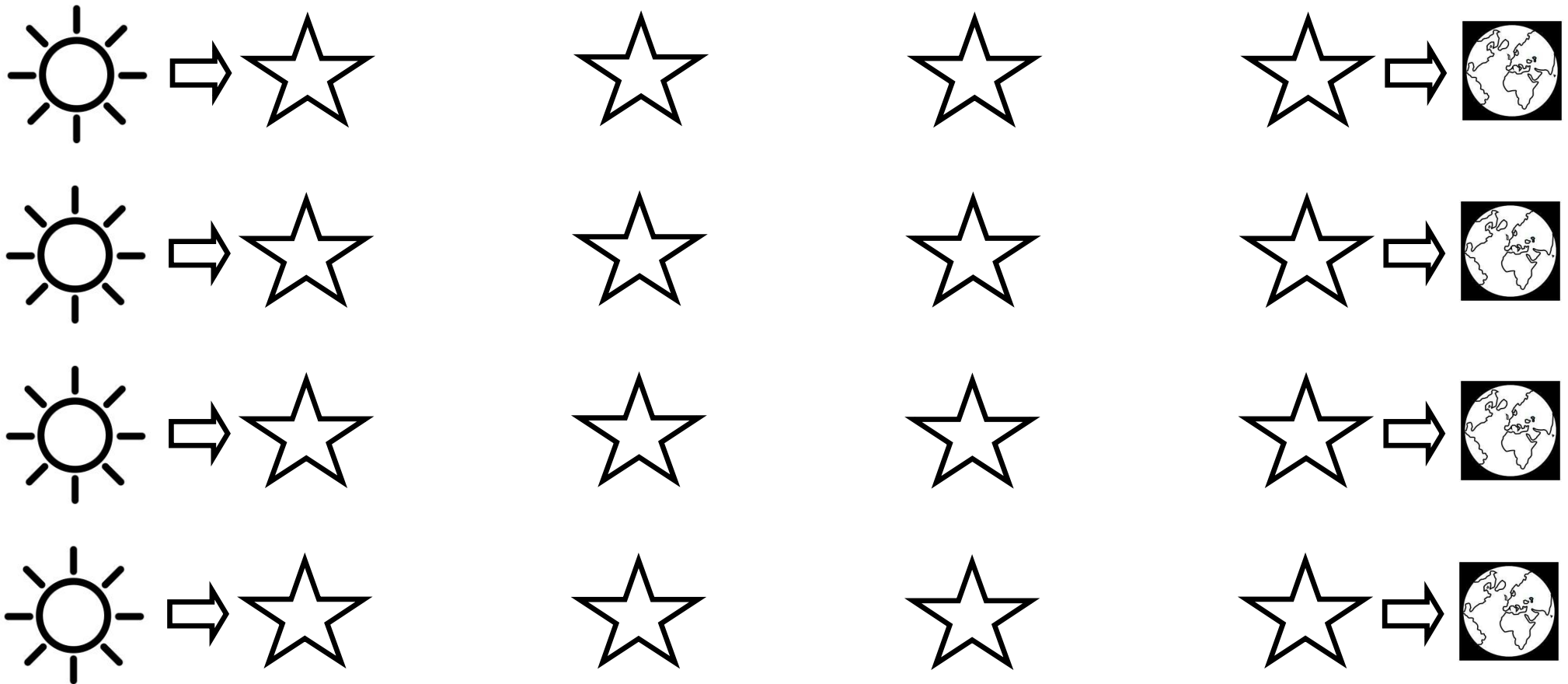

Actividades para mejorar motricidad fina

Sigue con tu lápiz los corazones para unir a la mama y a su bebe

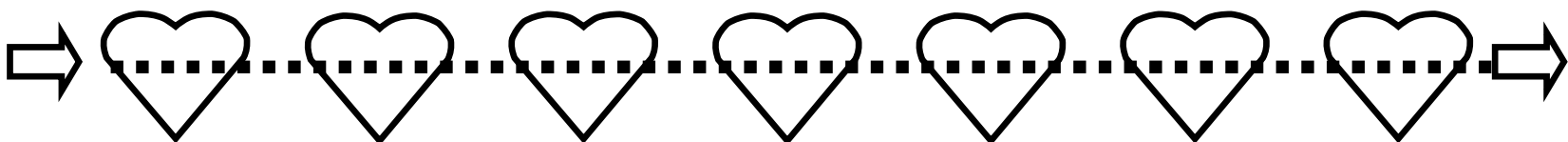
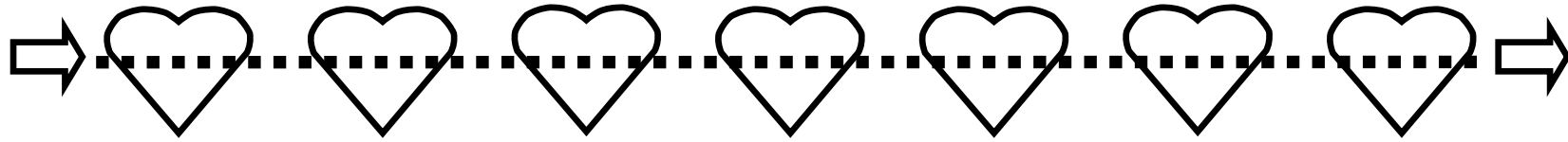

Actividades para mejorar motricidad fina

Sigue con tu lápiz los corazones para unir a la mama y a su bebe

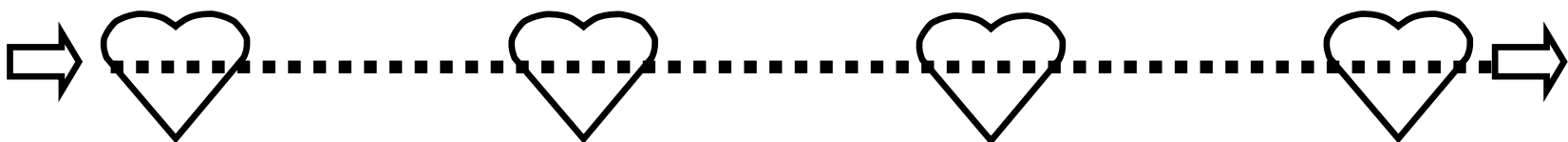
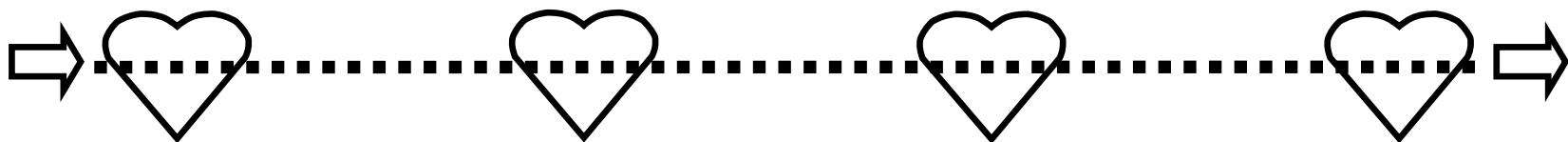
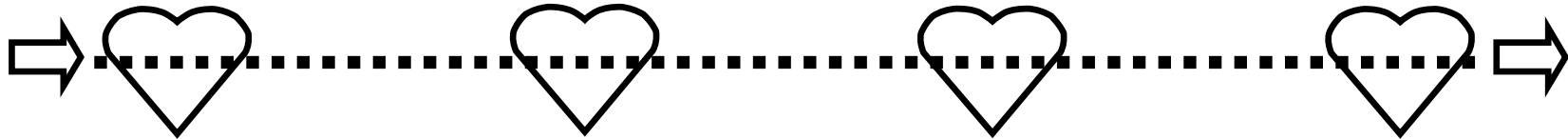
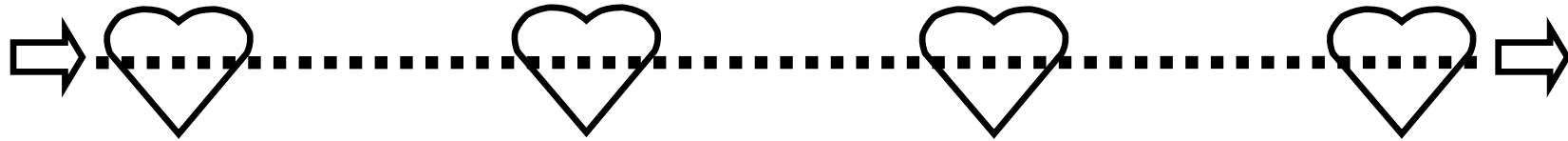

Actividades para mejorar motricidad fina

Sigue con tu lápiz los corazones para unir a la mama y a su bebe

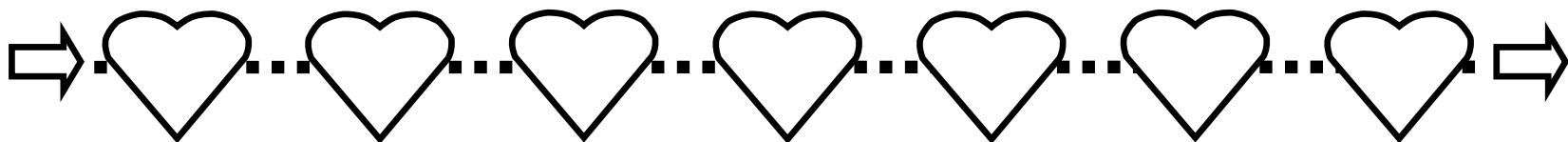

Actividades para mejorar motricidad fina

Sigue con tu lápiz los corazones para unir a la mama y a su bebe

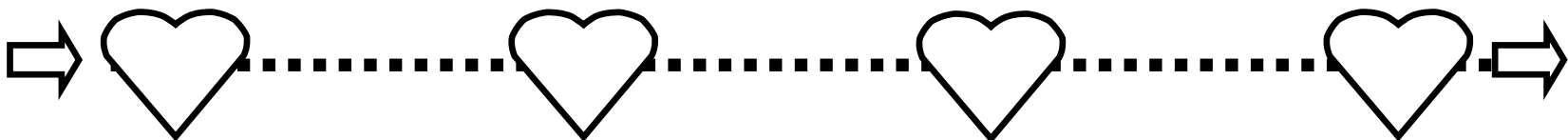
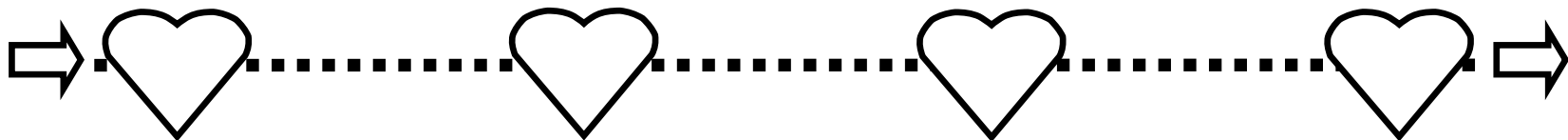
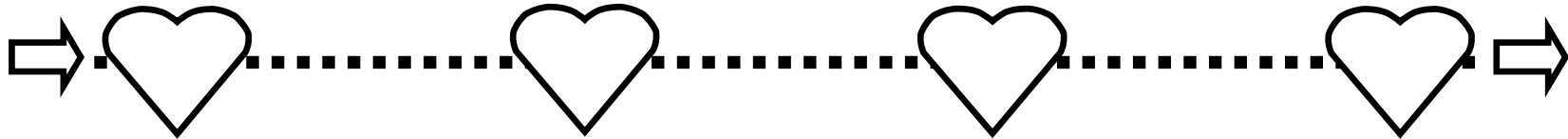
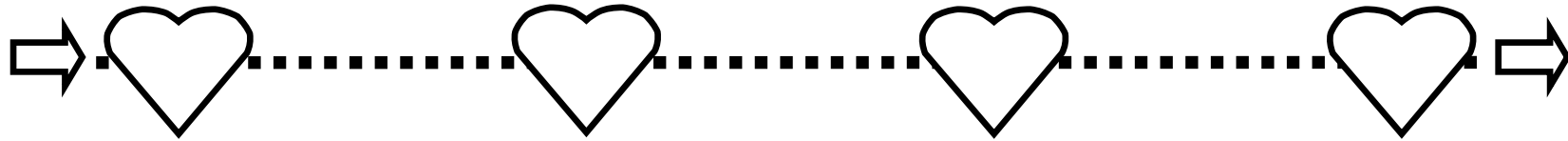

Actividades para mejorar motricidad fina

Sigue con tu lápiz los corazones para unir a la mama y a su bebe

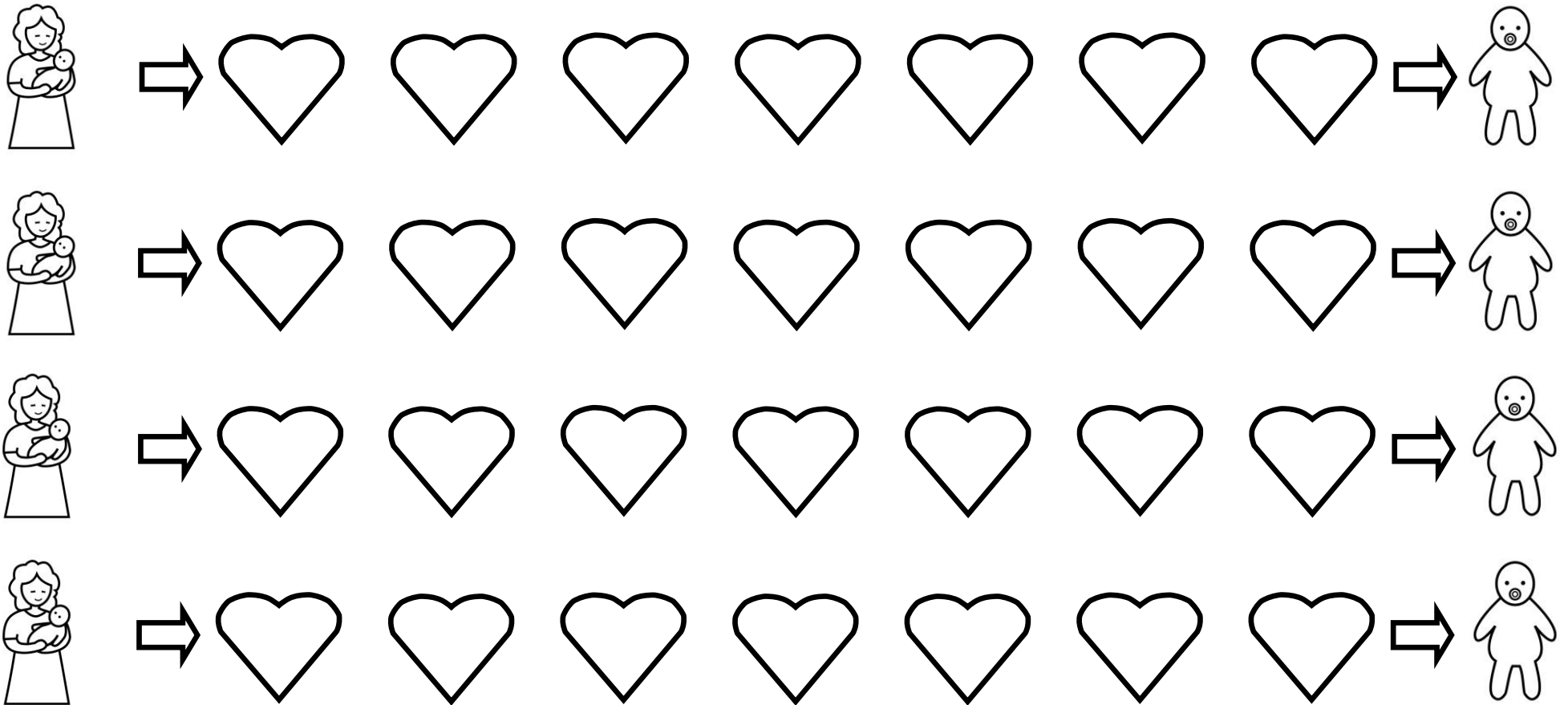

Actividades para mejorar motricidad fina

Sigue con tu lápiz los corazones para unir a la mama y a su bebe

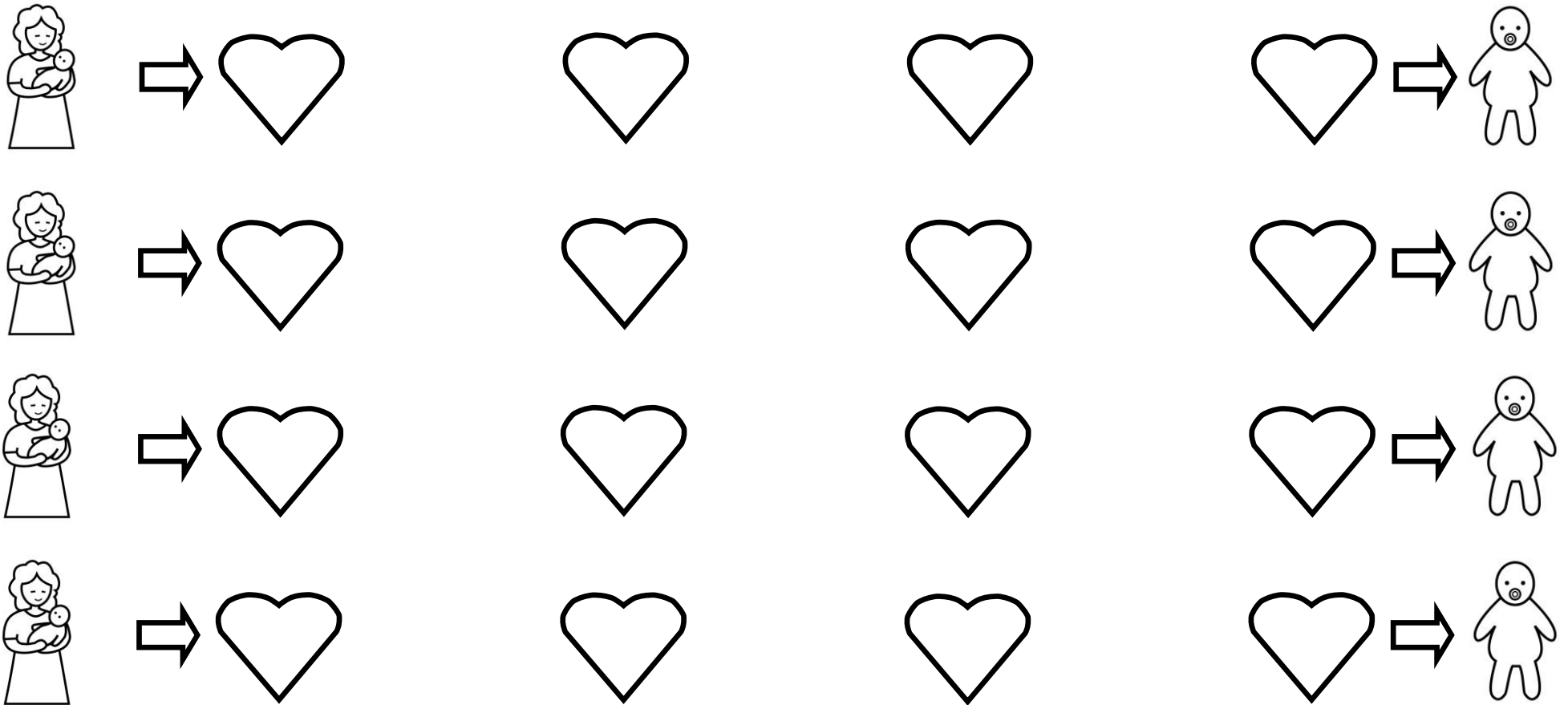

Actividades para mejorar motricidad fina

Sigue con tu lápiz las caras para unir al niño con su amiga

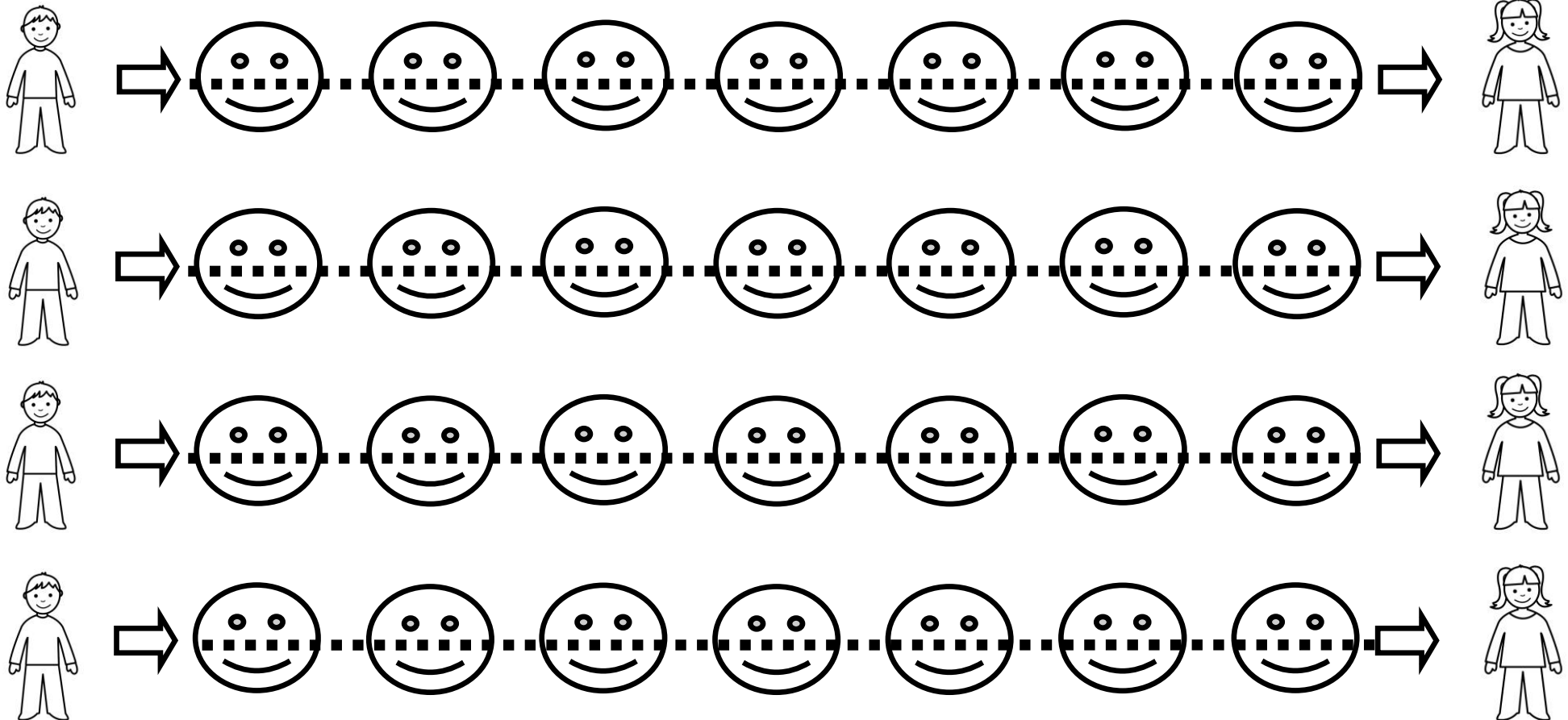

Actividades para mejorar motricidad fina

Sigue con tu lápiz las caras para unir al niño con su amiga

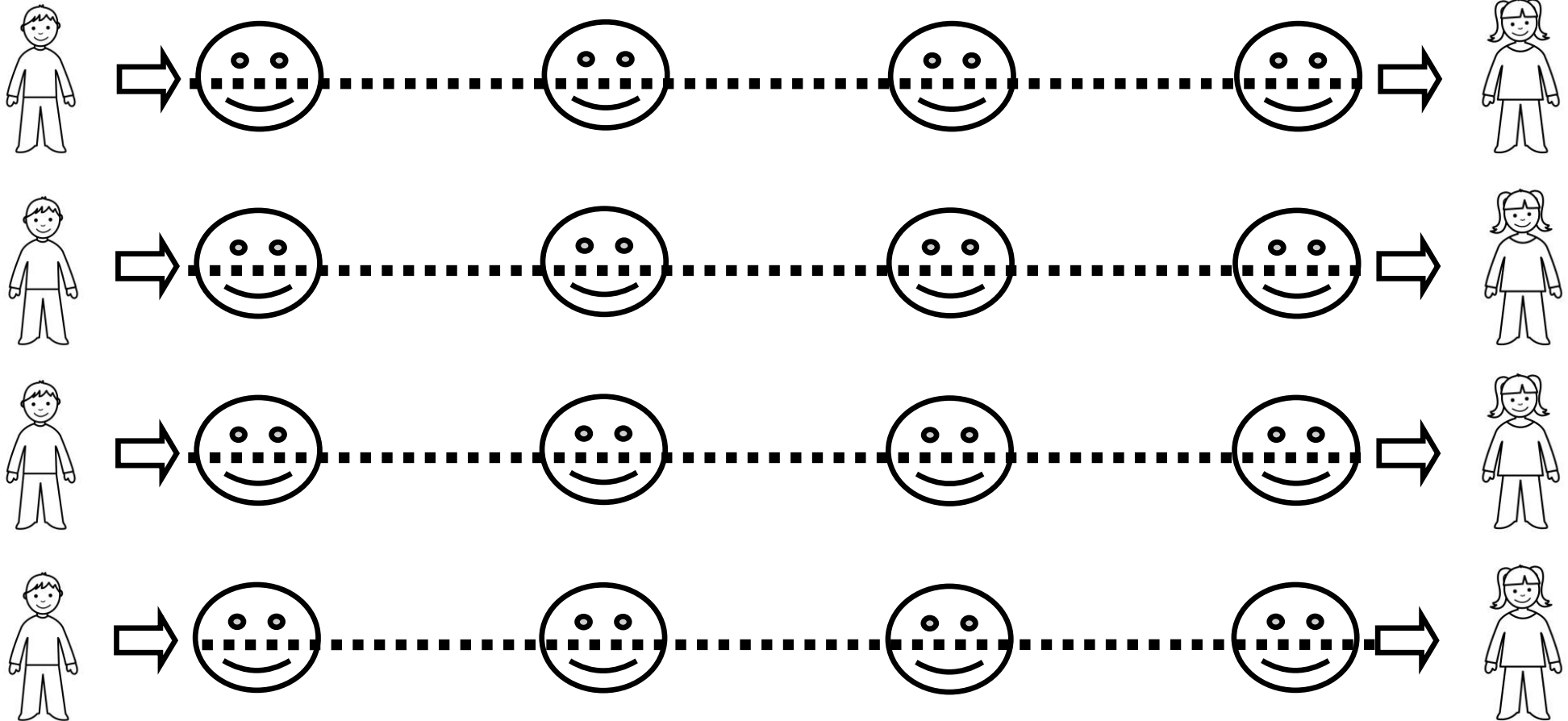

Actividades para mejorar motricidad fina

Sigue con tu lápiz las caras para unir al niño con su amiga

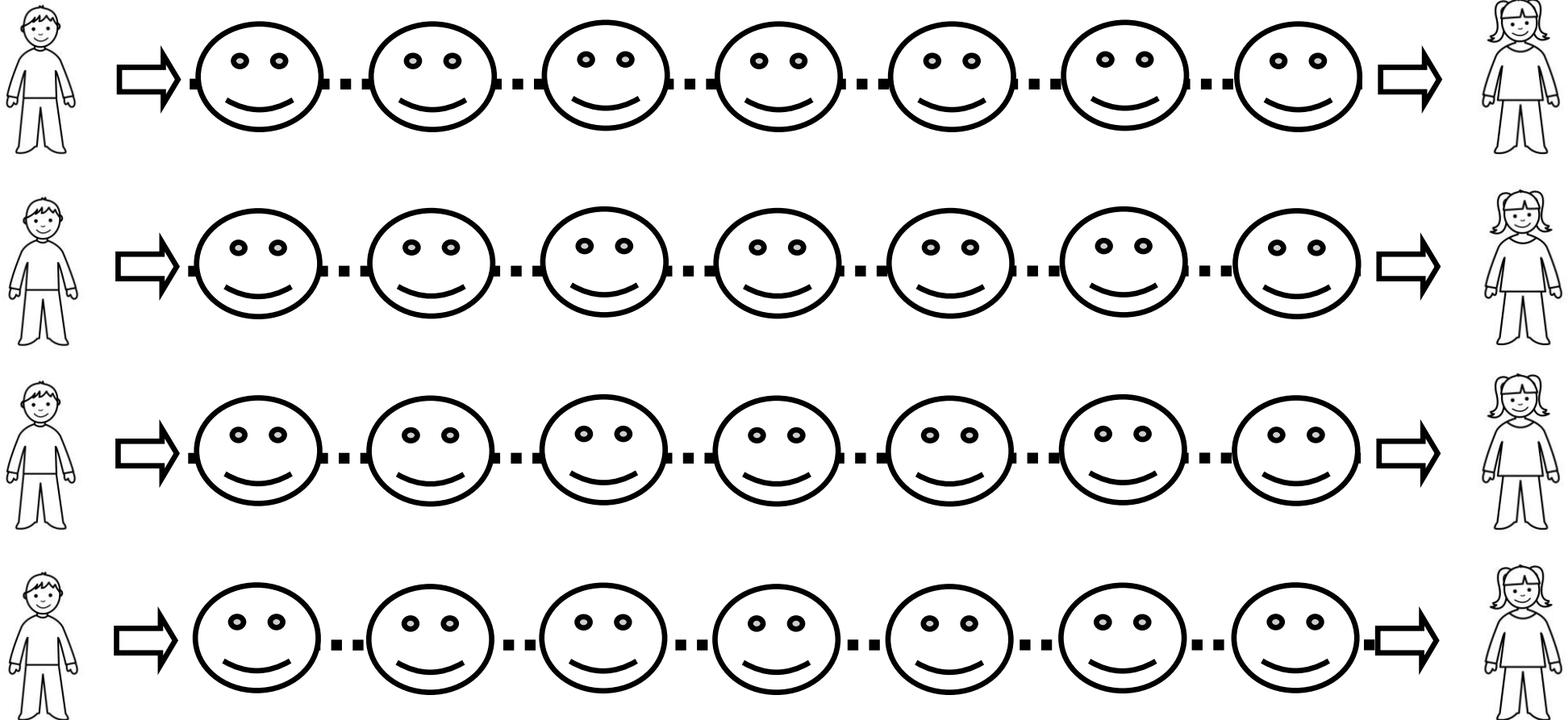

Actividades para mejorar motricidad fina

Sigue con tu lápiz las caras para unir al niño con su amiga

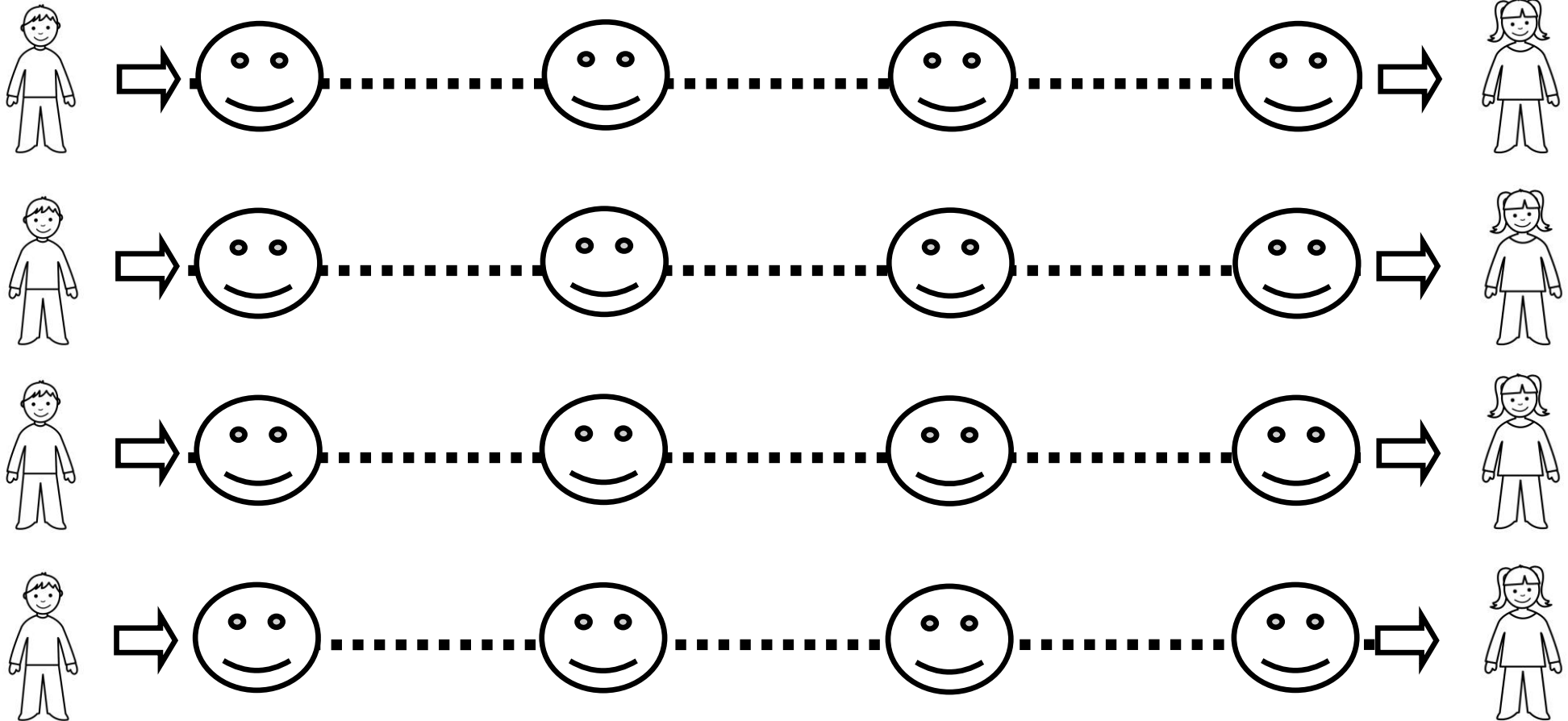

Actividades para mejorar motricidad fina

Sigue con tu lápiz las caras para unir al niño con su amiga

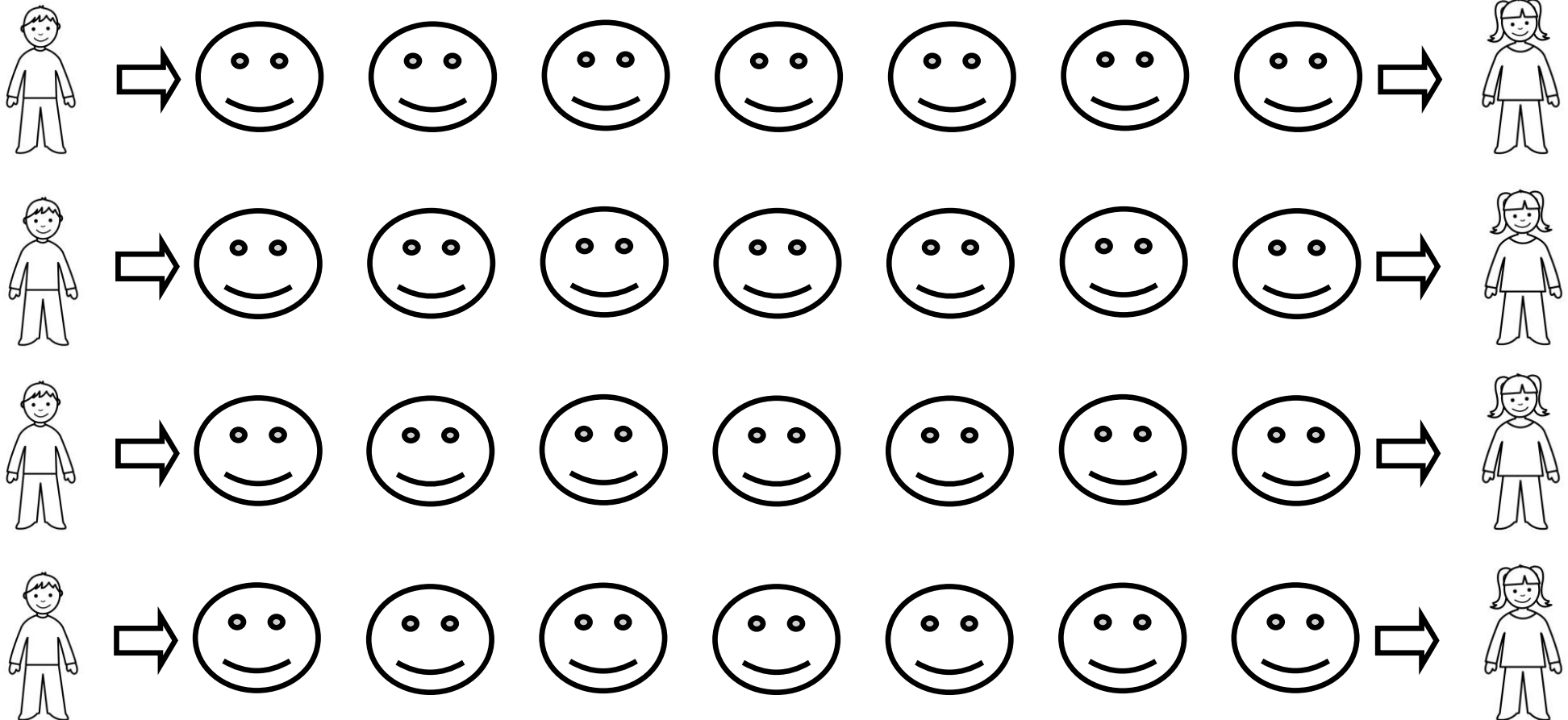

Actividades para mejorar motricidad fina

Sigue con tu lápiz las caras para unir al niño con su amiga

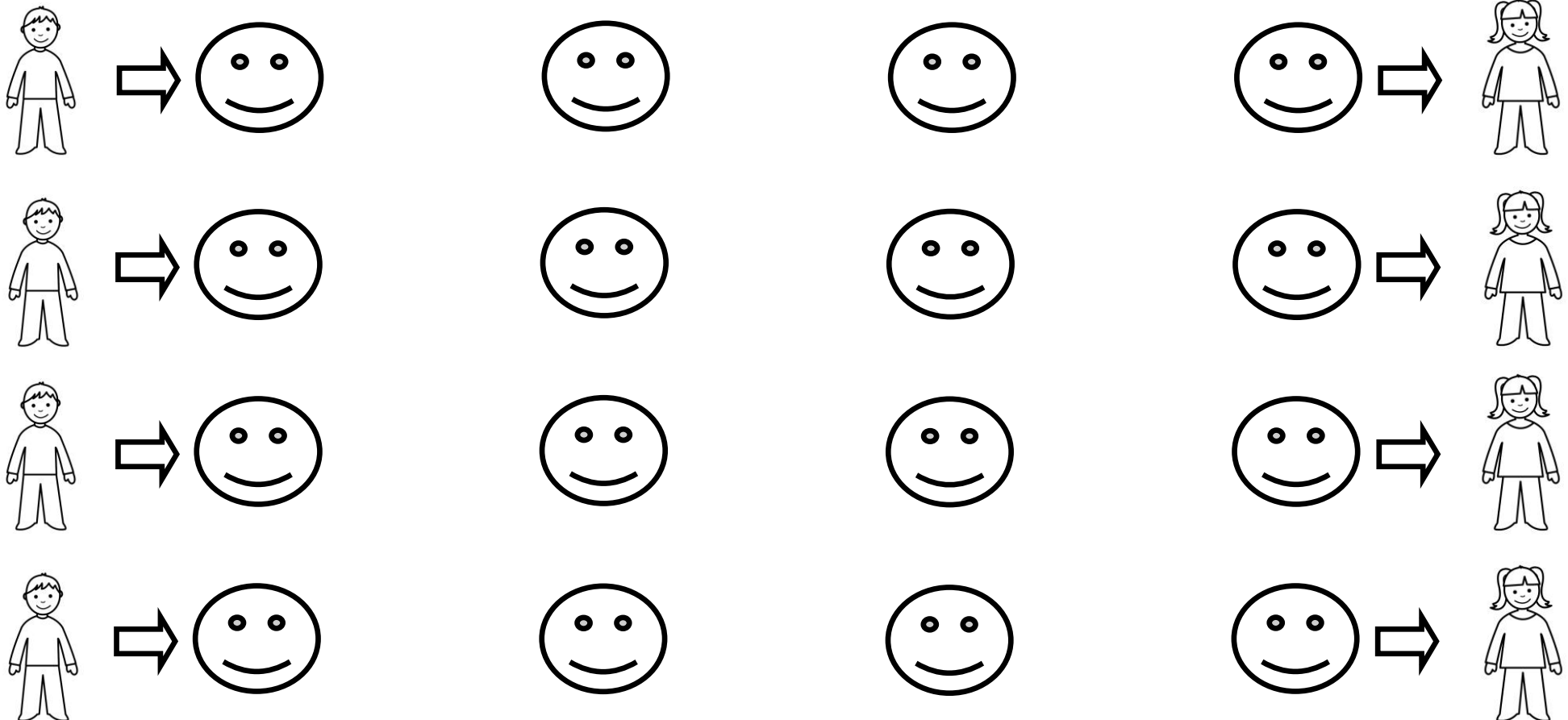

Actividades para mejorar motricidad fina

Sigue con tu lápiz los círculos para unir al niño con su balón

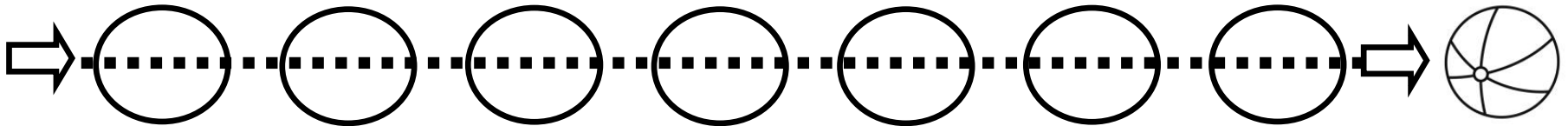
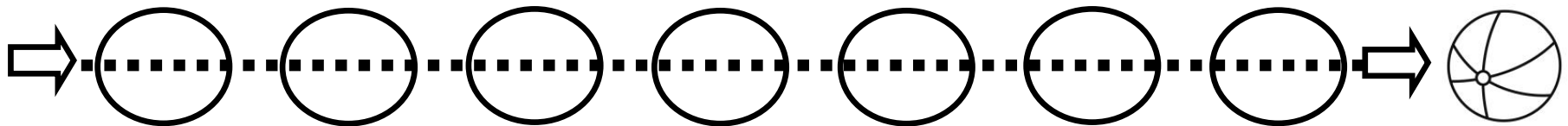
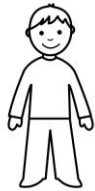
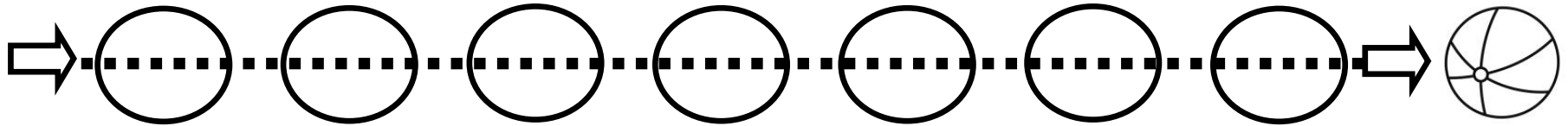
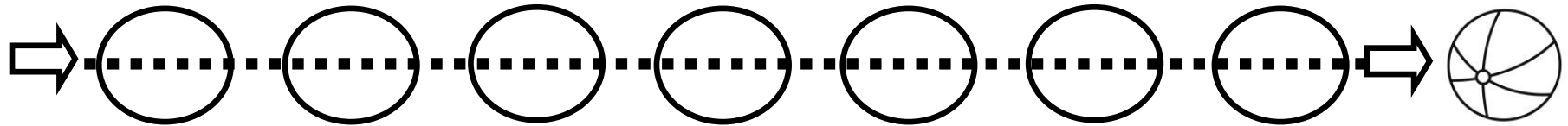
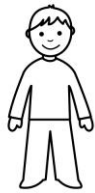

Actividades para mejorar motricidad fina

Sigue con tu lápiz los círculos para unir al niño con su balón

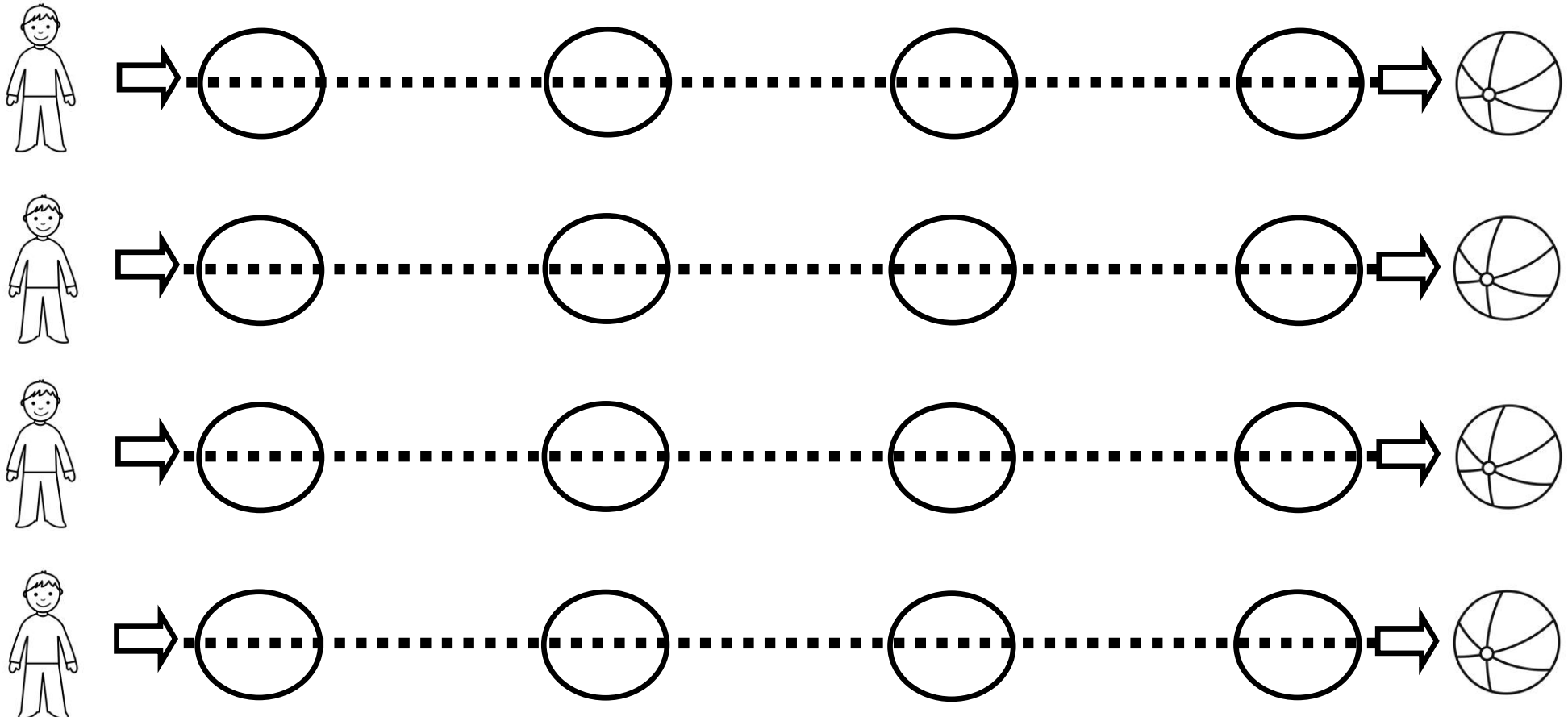

Actividades para mejorar motricidad fina

Sigue con tu lápiz los círculos para unir al niño con su balón

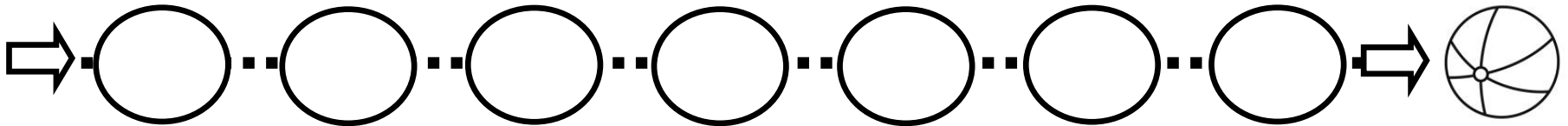
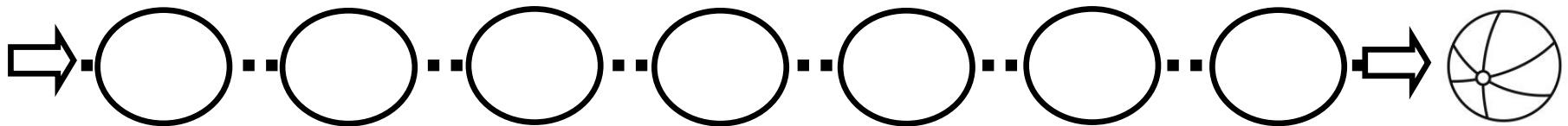
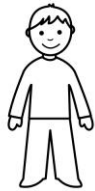
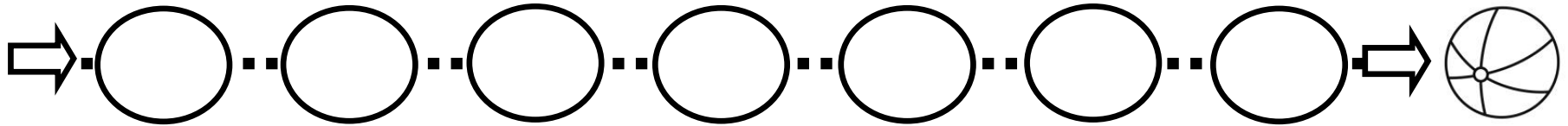
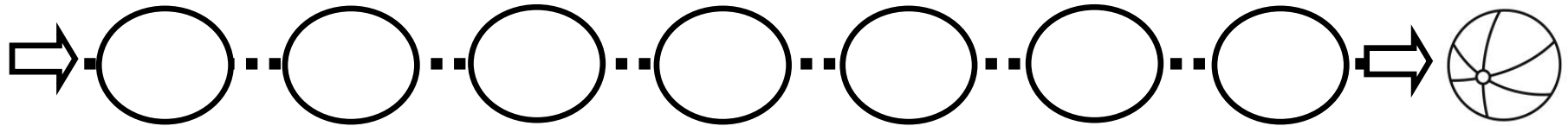

Actividades para mejorar motricidad fina

Sigue con tu lápiz los círculos para unir al niño con su balón

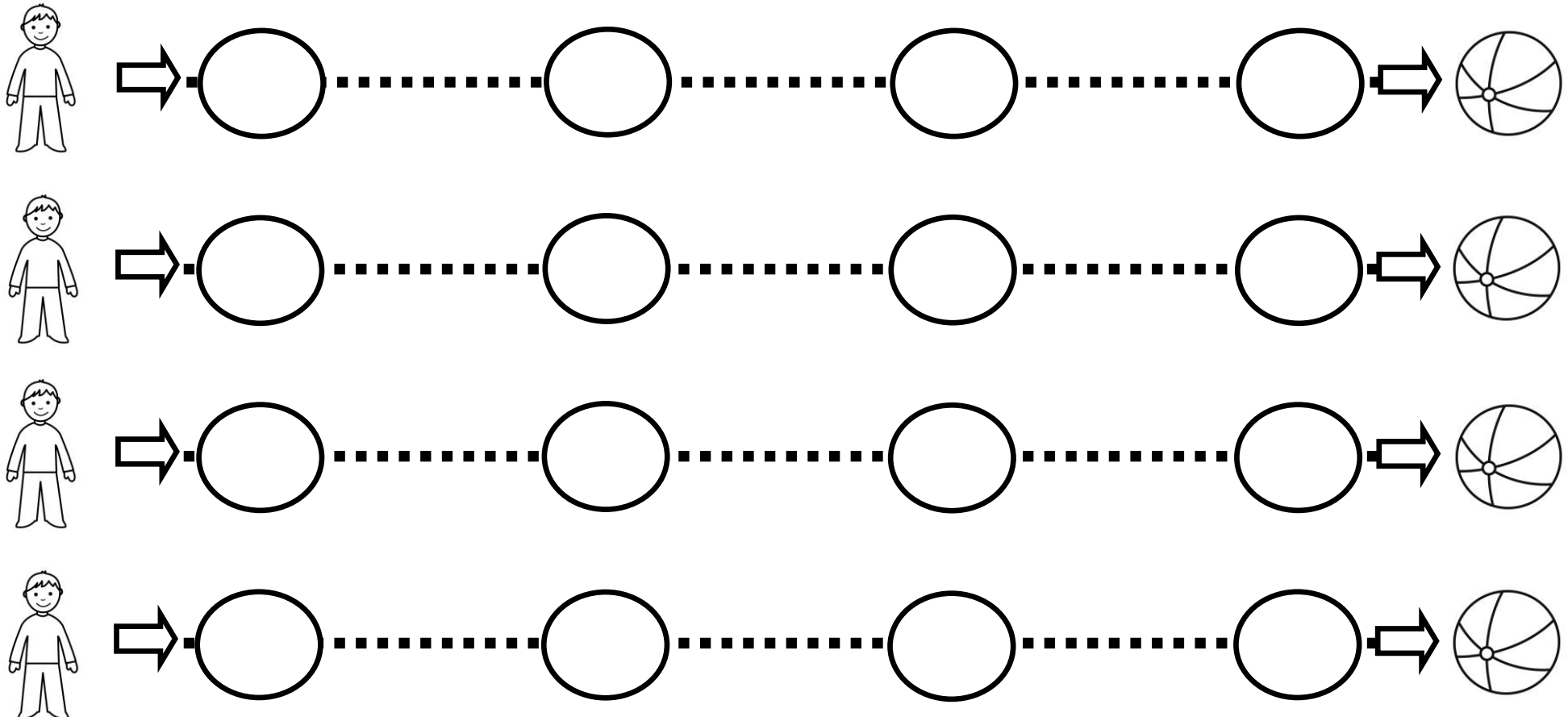

Actividades para mejorar motricidad fina

Sigue con tu lápiz los círculos para unir al niño con su balón

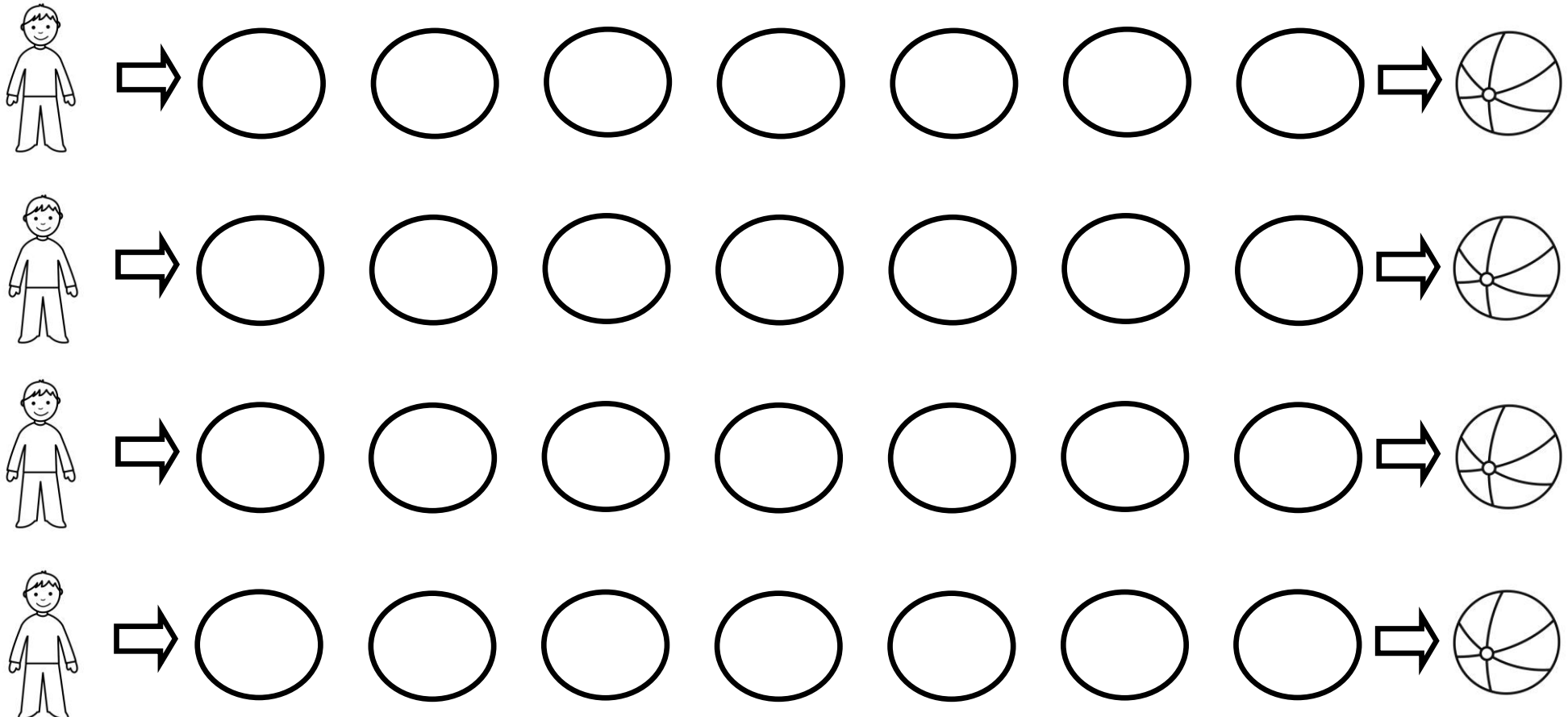

Actividades para mejorar motricidad fina

Sigue con tu lápiz los círculos para unir al niño con su balón

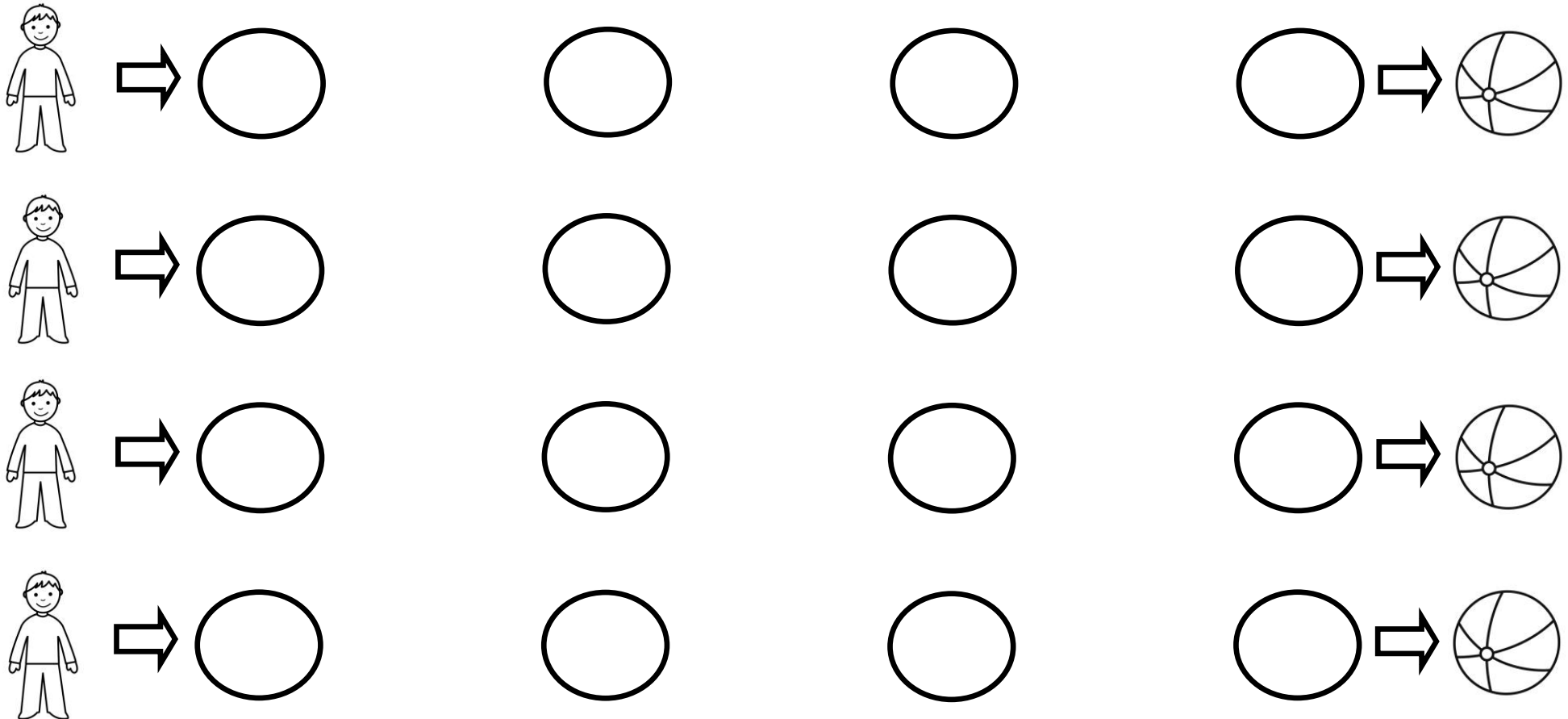

Actividades para mejorar motricidad fina

Sigue con tu lápiz los rayos para unir a nube y la tierra

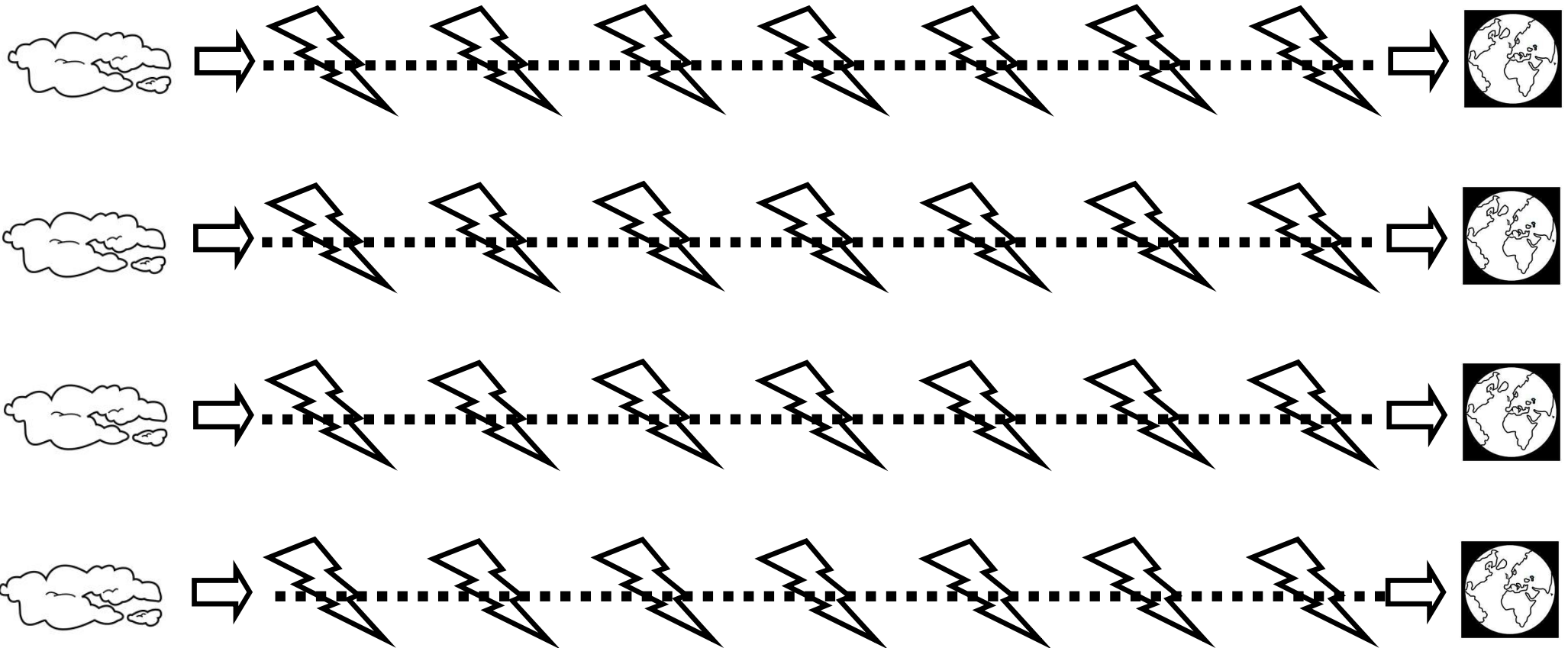

Actividades para mejorar motricidad fina

Sigue con tu lápiz los rayos para unir a nube y la tierra

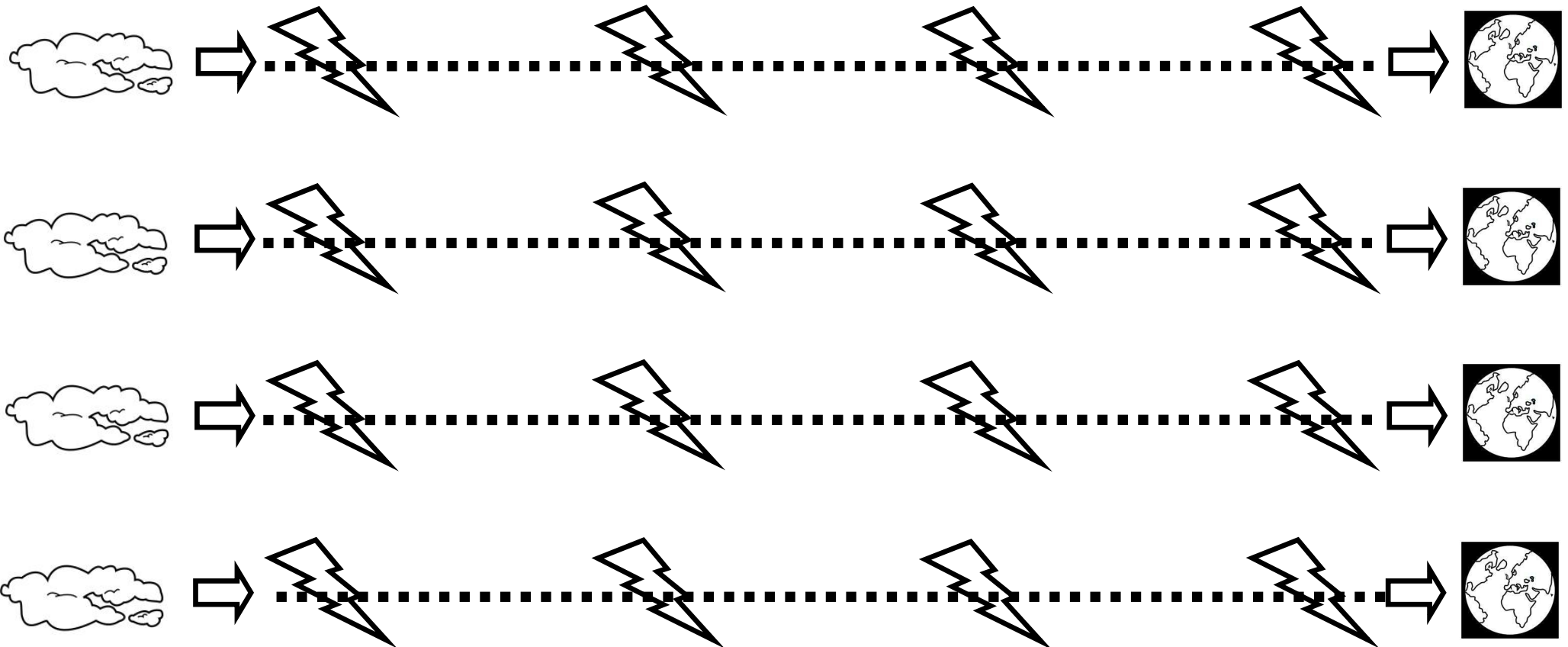

Actividades para mejorar motricidad fina

Sigue con tu lápiz los rayos para unir a nube y la tierra

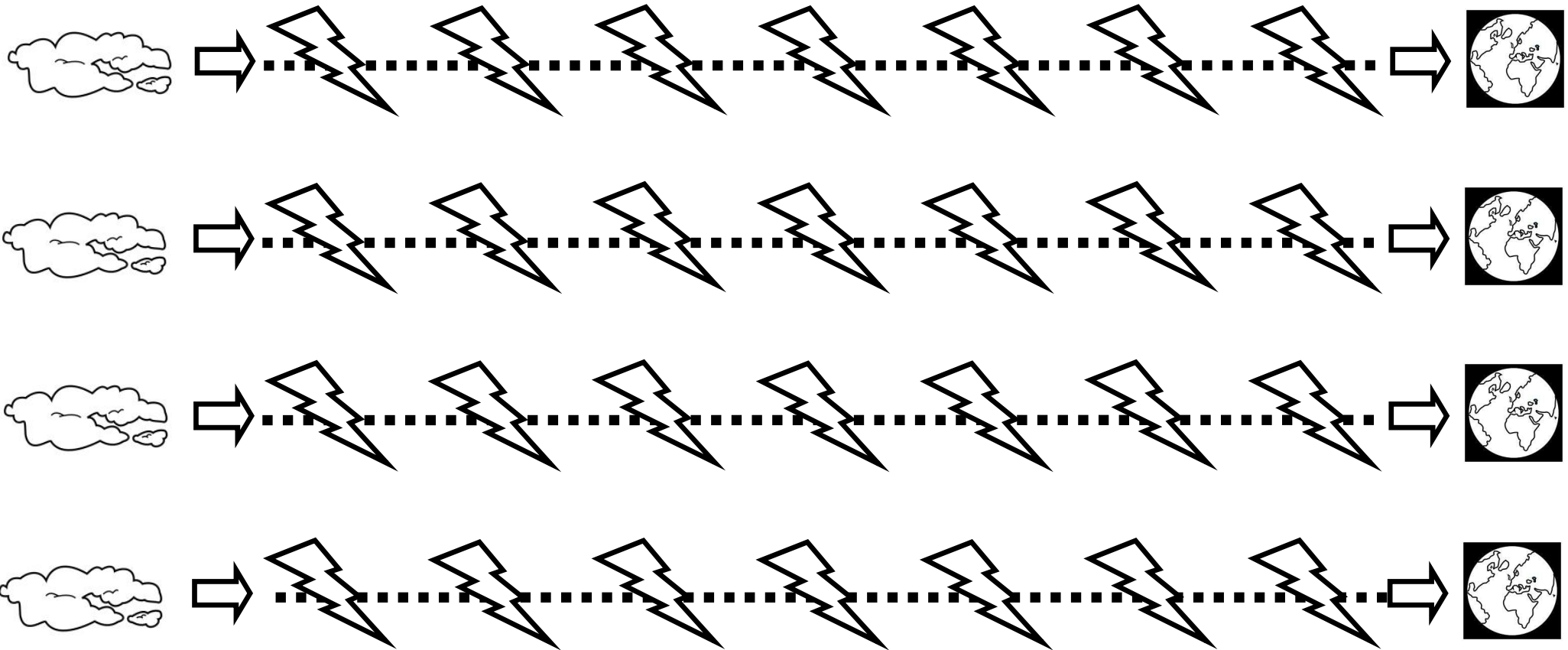

Actividades para mejorar motricidad fina

Sigue con tu lápiz los rayos para unir a nube y la tierra

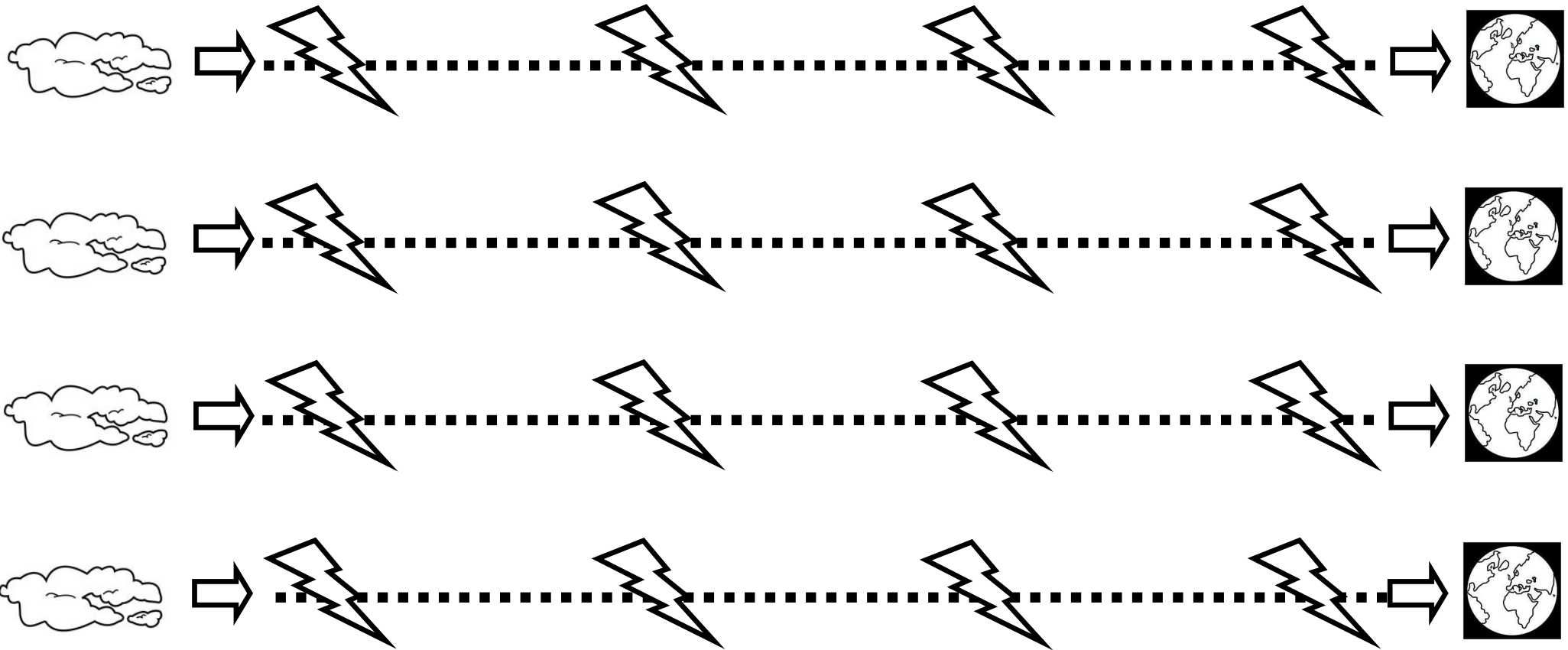

Actividades para mejorar motricidad fina

Sigue con tu lápiz los rayos para unir a nube y la tierra

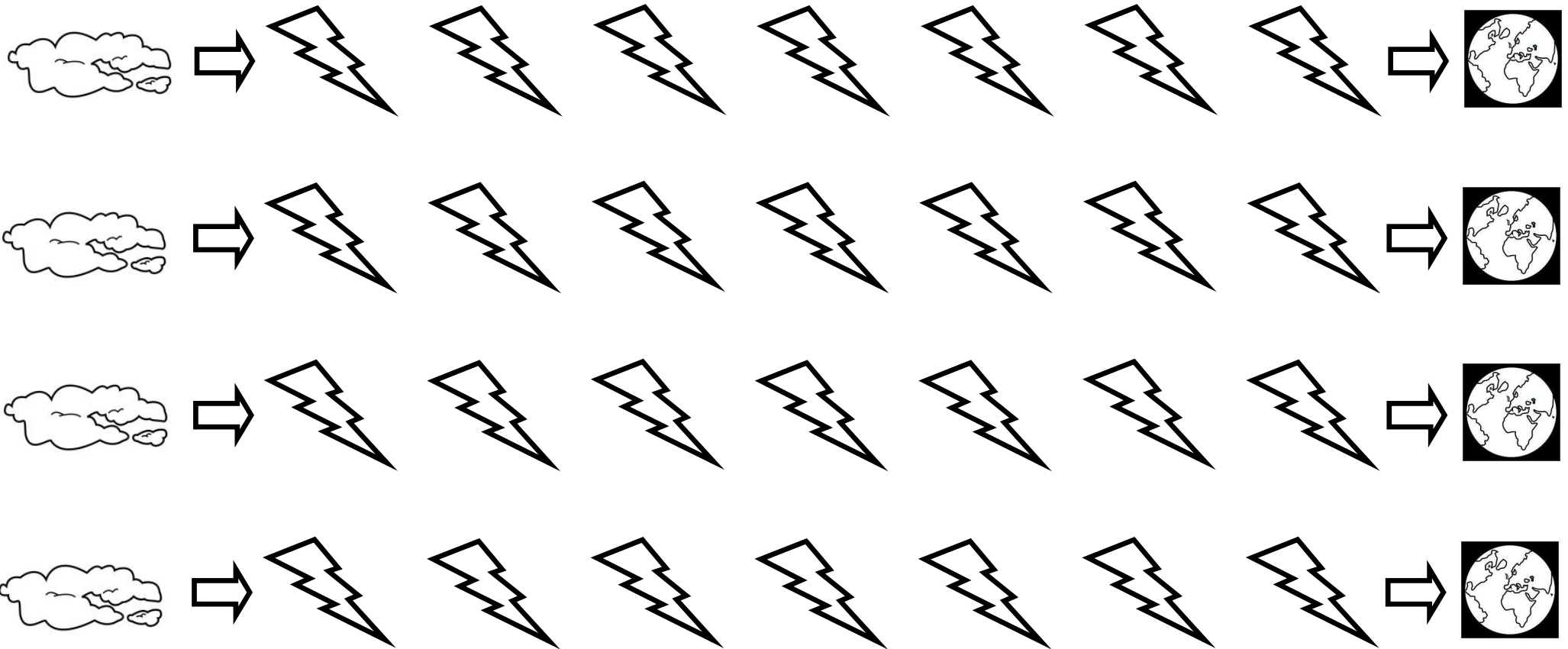

Actividades para mejorar motricidad fina

Sigue con tu lápiz los rayos para unir a nube y la tierra

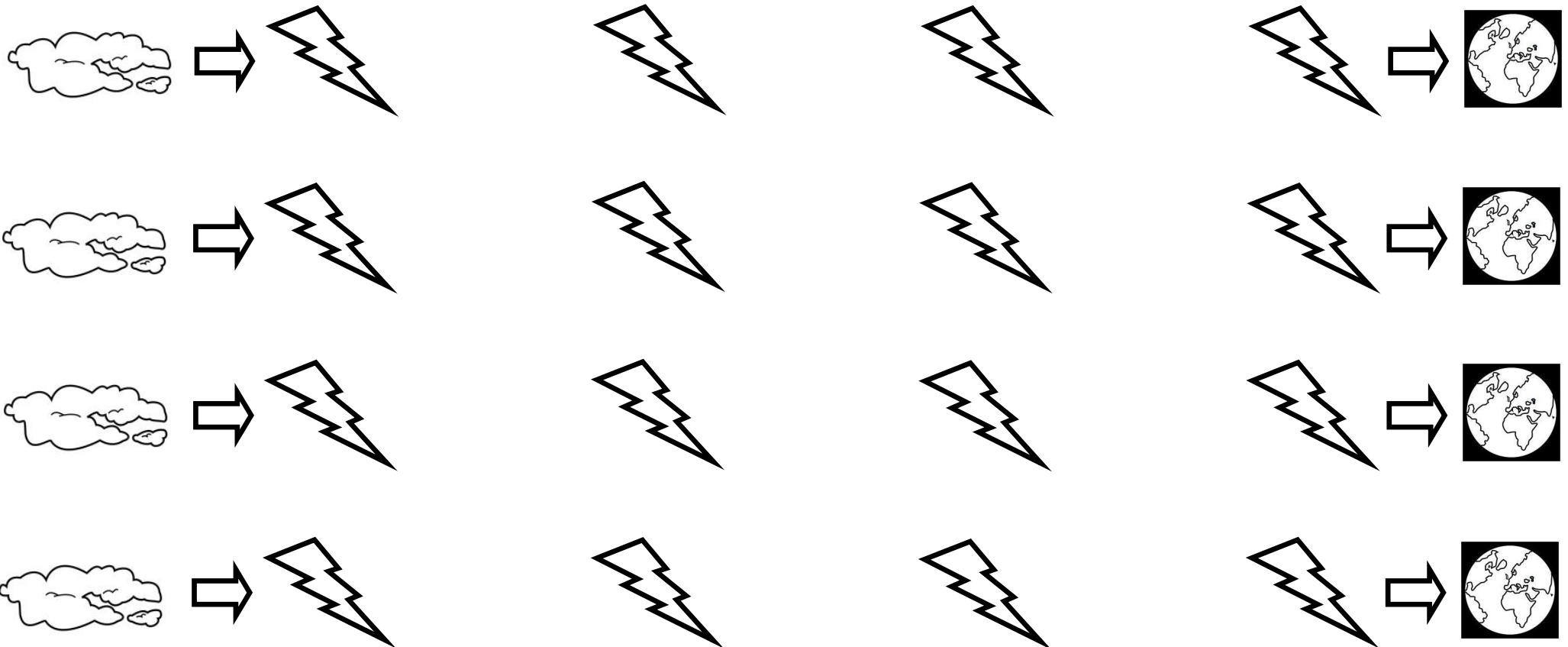

Actividades para mejorar motricidad fina

Sigue con tu lápiz las estrellitas para ir desde el sol a la tierra

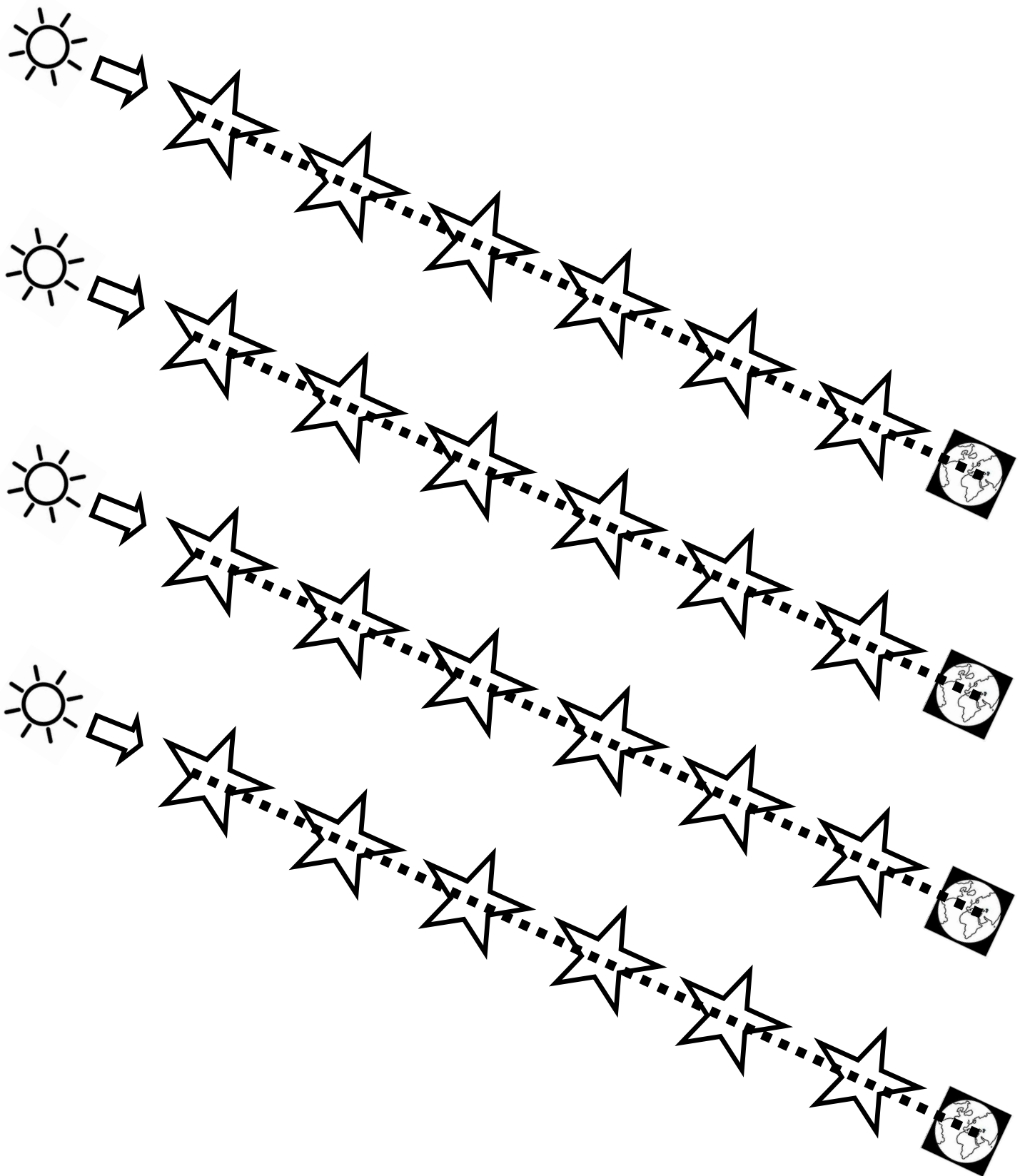

Actividades para mejorar motricidad fina

Sigue con tu lápiz las estrellitas para ir desde el sol a la tierra

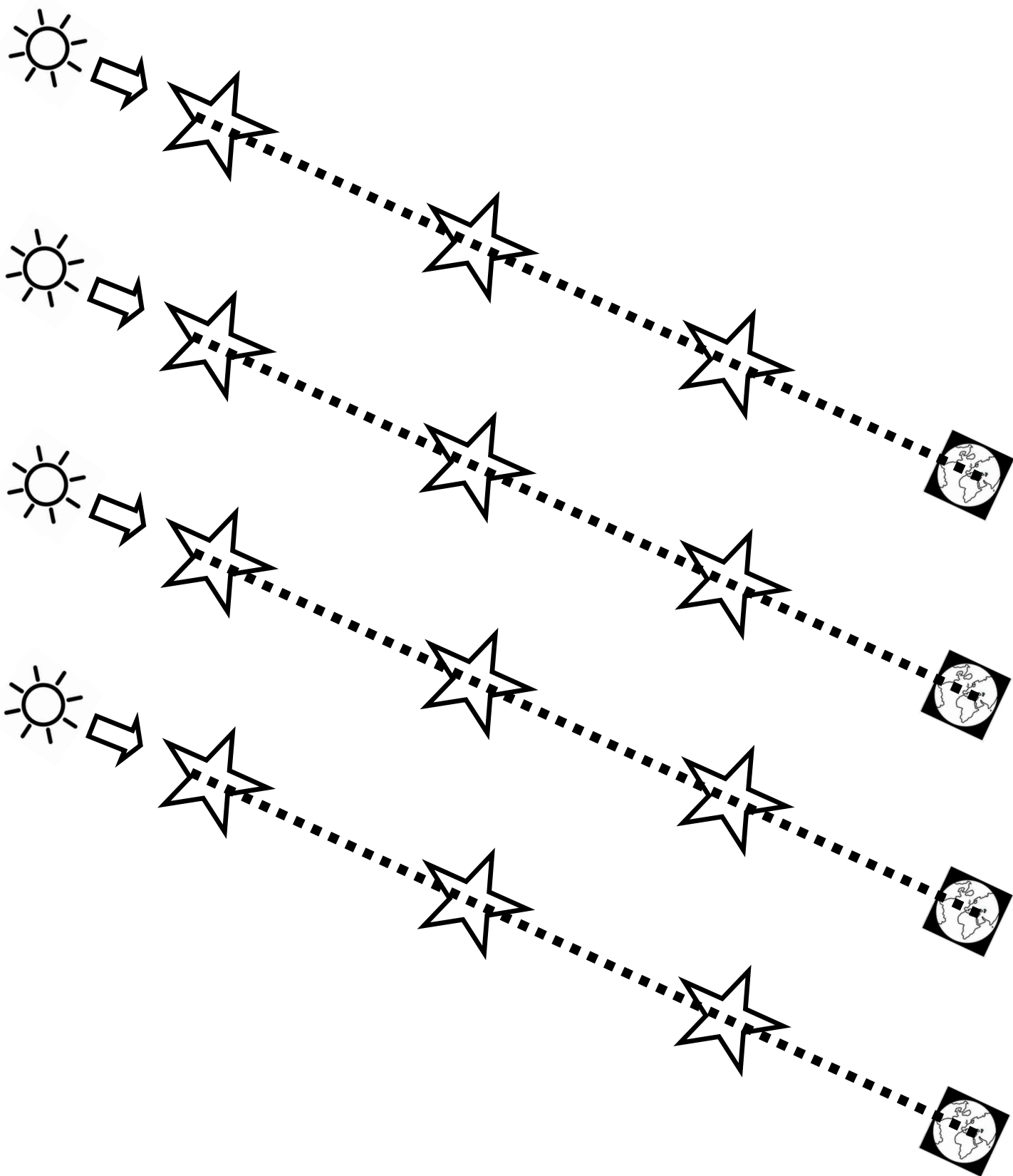

Actividades para mejorar motricidad fina

Sigue con tu lápiz las estrellitas para ir desde el sol a la tierra

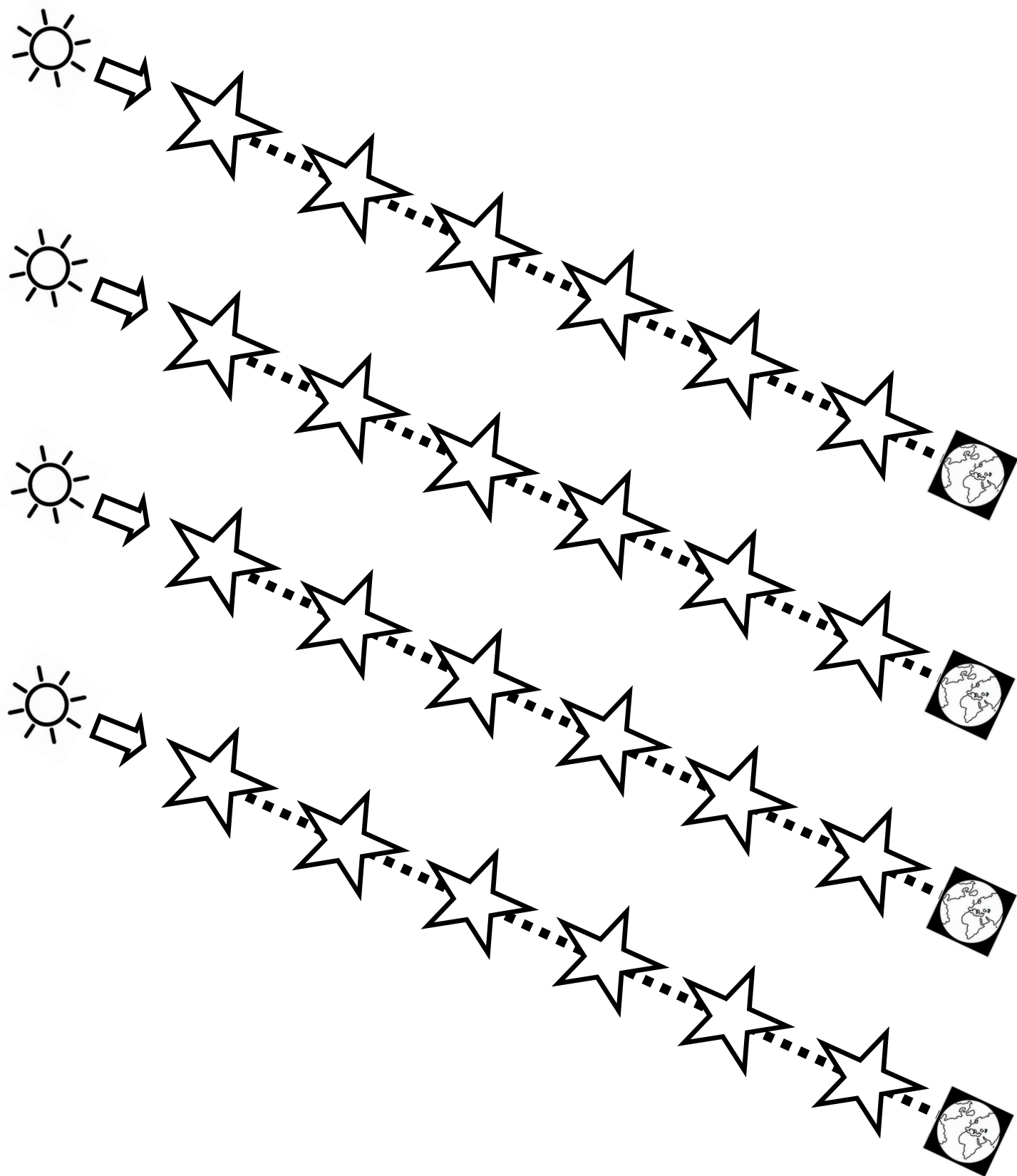

Actividades para mejorar motricidad fina

Sigue con tu lápiz las estrellitas para ir desde el sol a la tierra

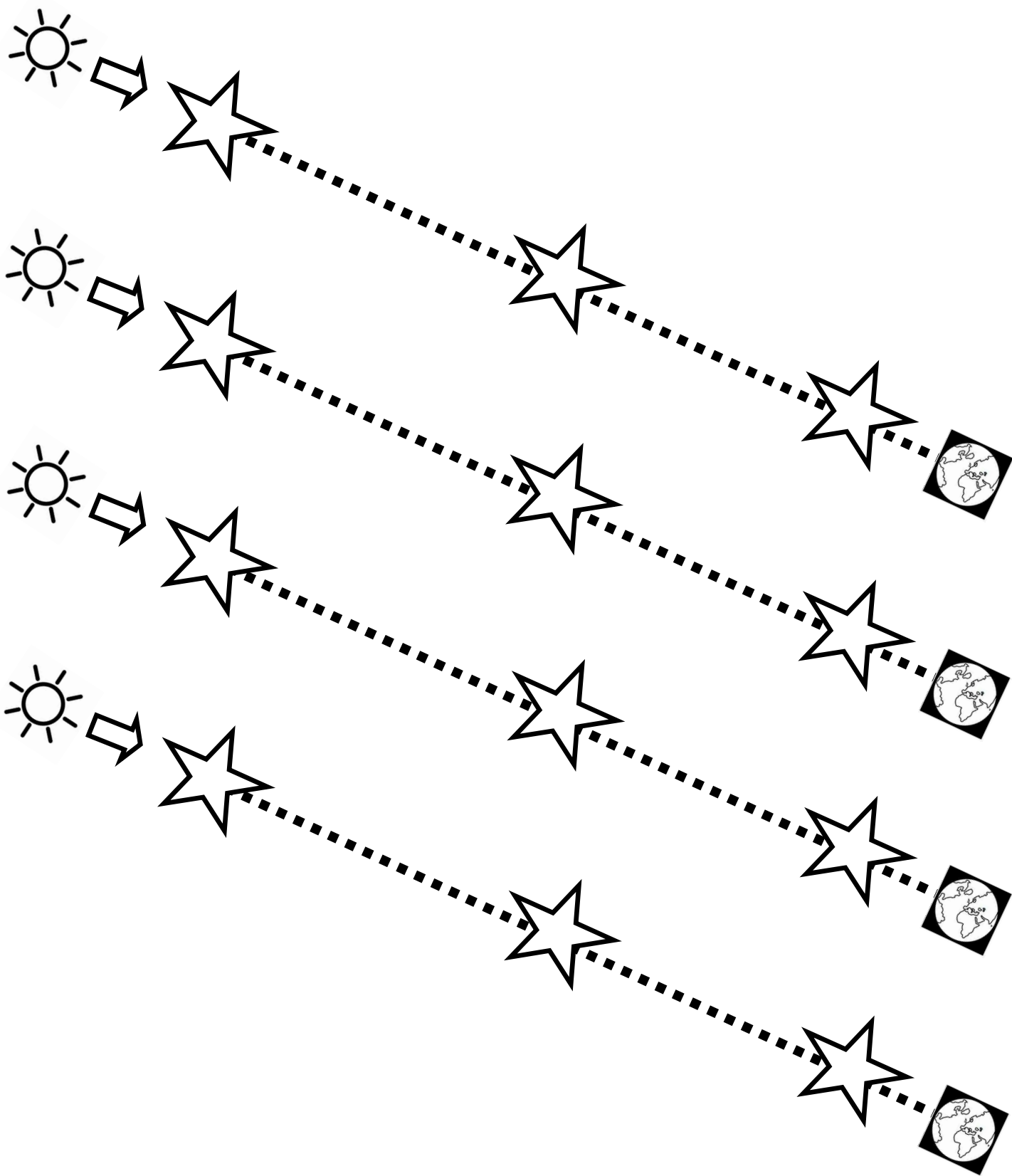

Actividades para mejorar motricidad fina

Sigue con tu lápiz las estrellitas para ir desde el sol a la tierra



Actividades para mejorar motricidad fina

Sigue con tu lápiz las estrellitas para ir desde el sol a la tierra

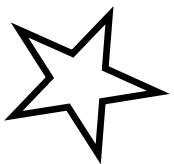
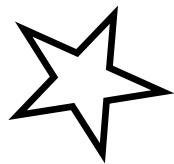
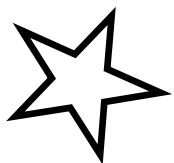
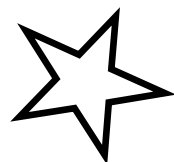
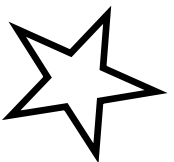
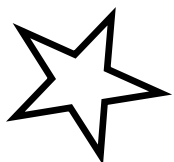
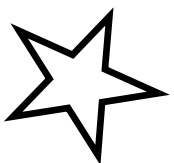
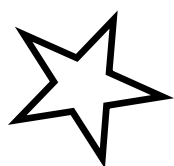
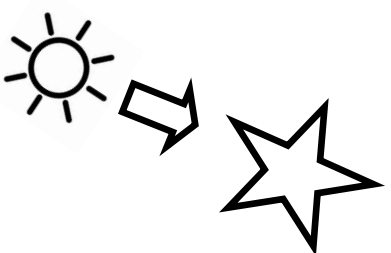
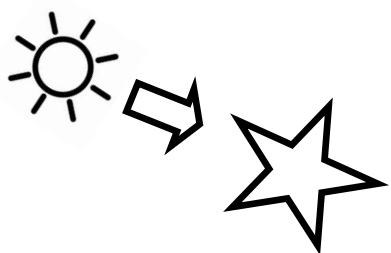
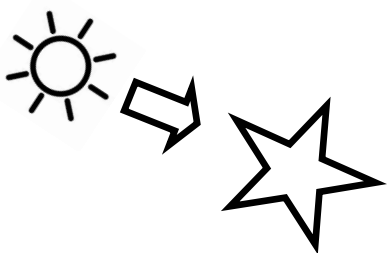
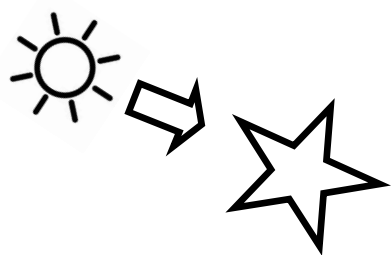

Actividades para mejorar motricidad fina

Sigue con tu lápiz los corazones para unir a la mama y a su bebe

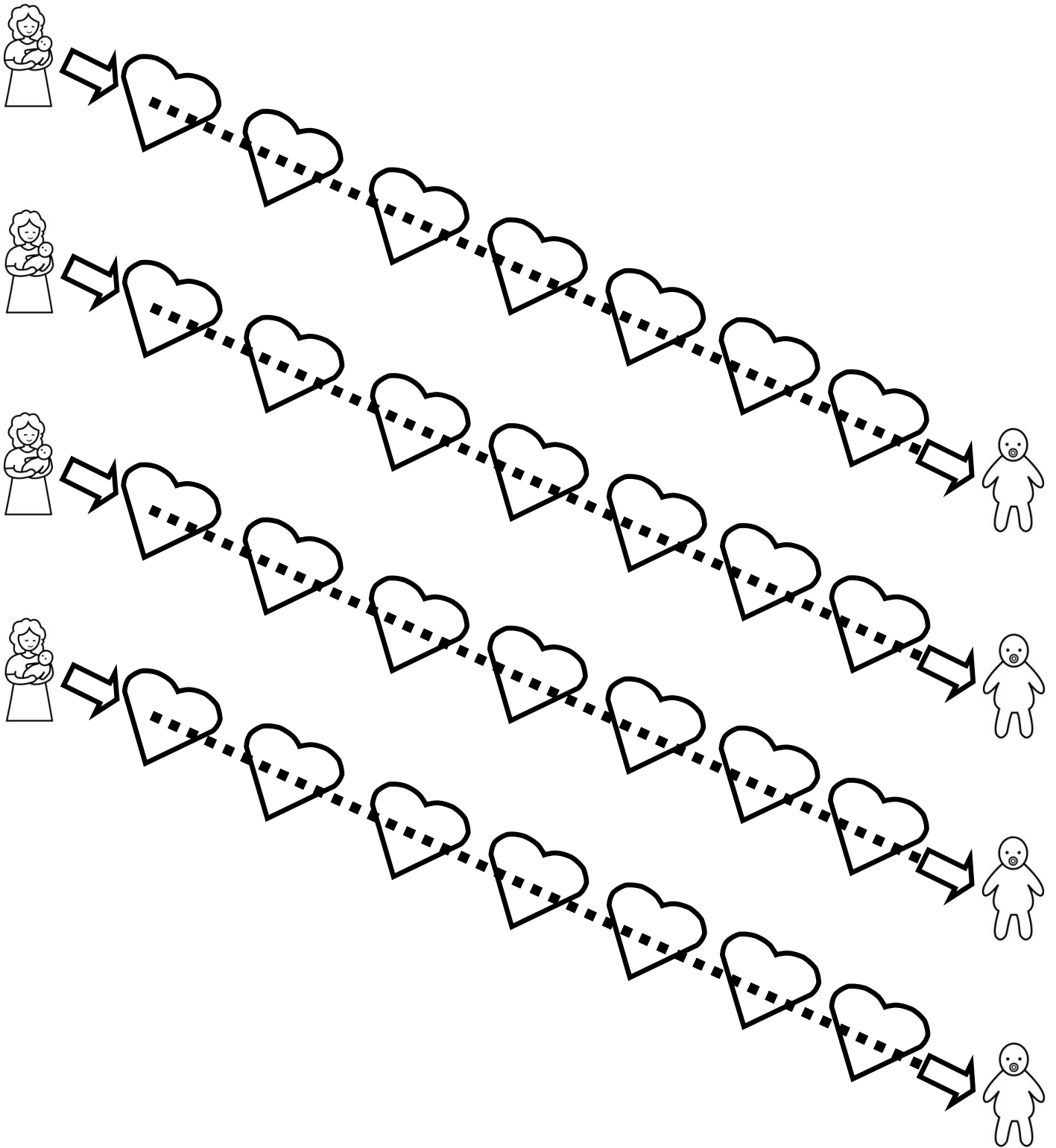

Actividades para mejorar motricidad fina

Sigue con tu lápiz los corazones para unir a la mama y a su bebe

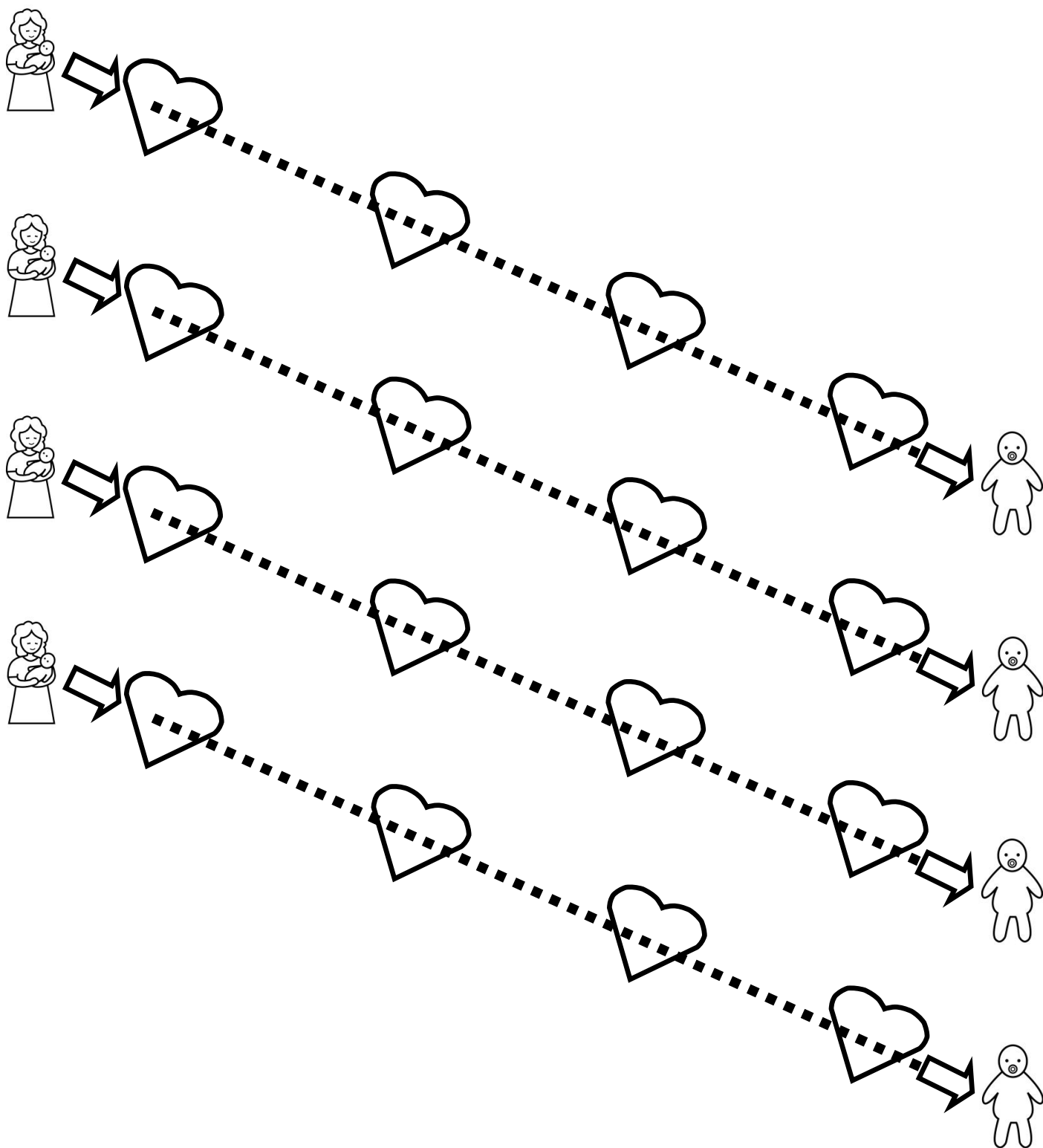

Actividades para mejorar motricidad fina

Sigue con tu lápiz los corazones para unir a la mama y a su bebe

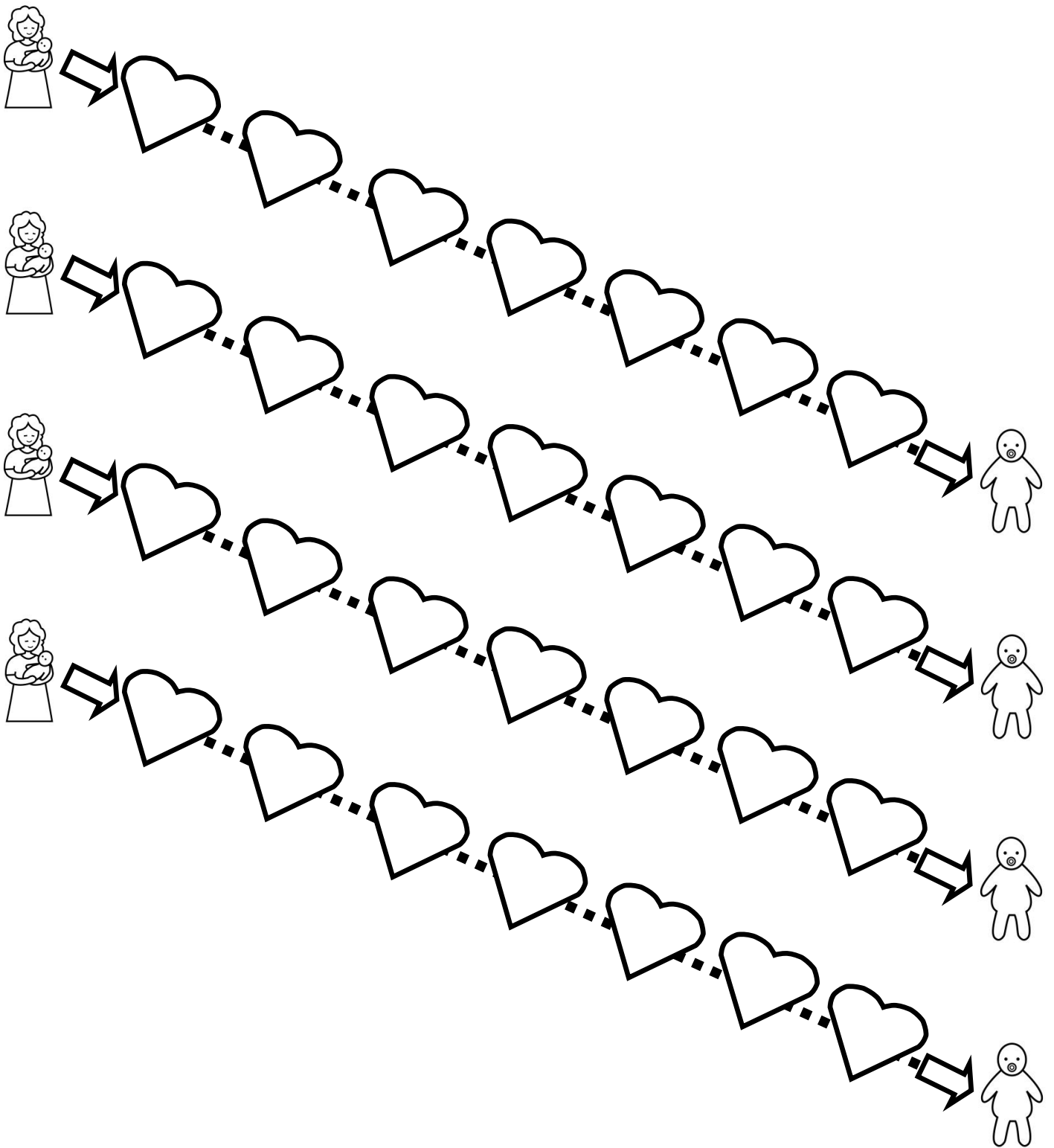

Actividades para mejorar motricidad fina

Sigue con tu lápiz los corazones para unir a la mama y a su bebe

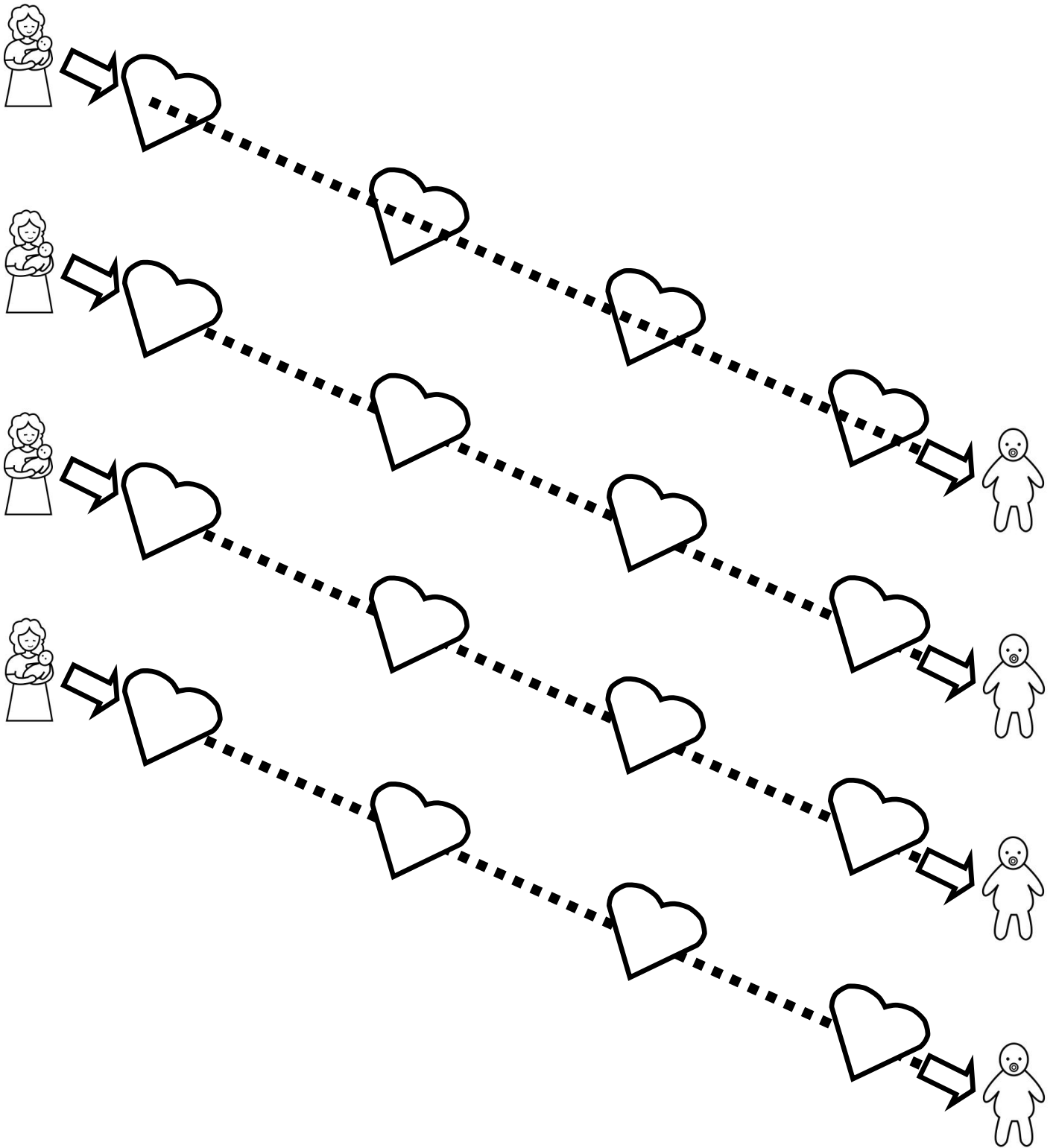

Actividades para mejorar motricidad fina

Sigue con tu lápiz los corazones para unir a la mama y a su bebe

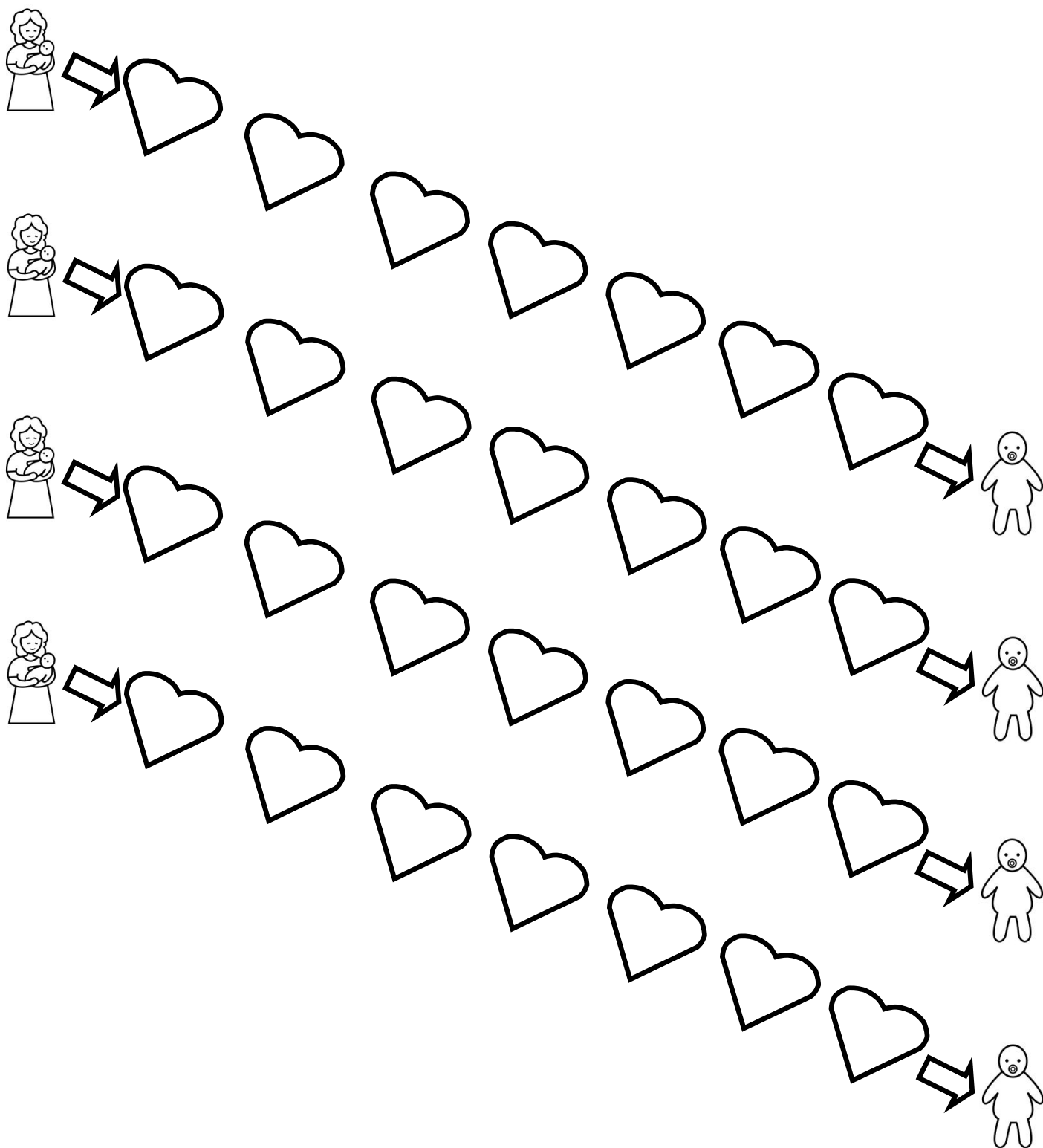

Actividades para mejorar motricidad fina

Sigue con tu lápiz los corazones para unir a la mama y a su bebe

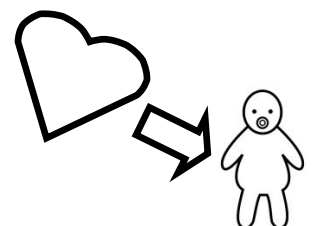
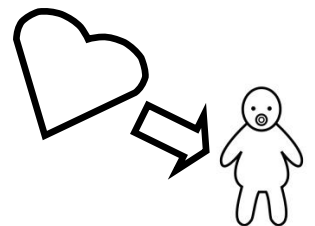
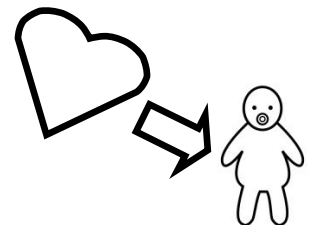
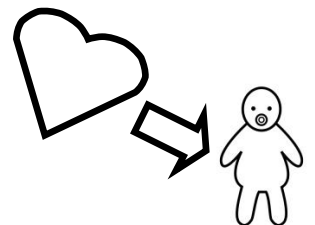
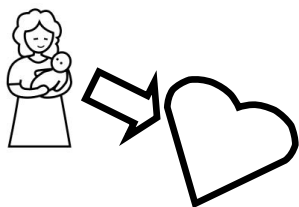
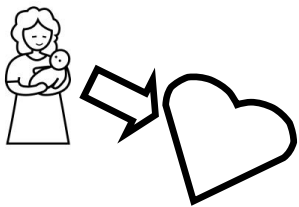
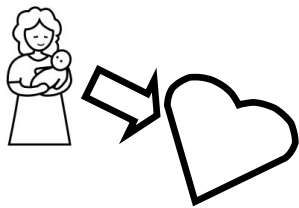
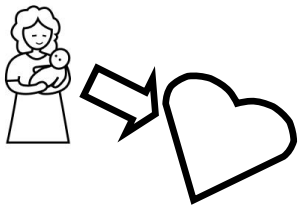

Actividades para mejorar motricidad fina

Sigue con tu lápiz las caras para unir al niño con su amiga

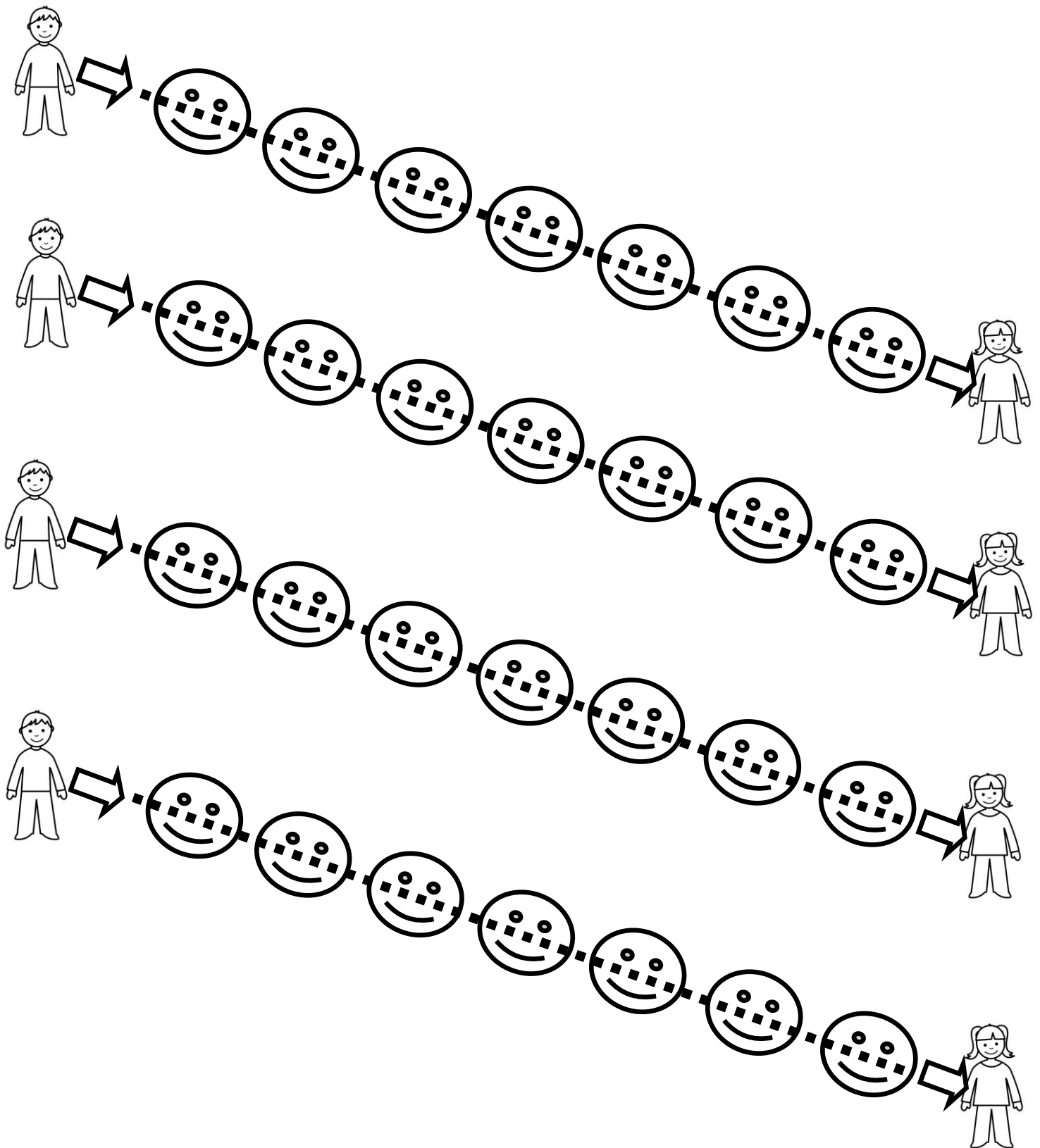

Actividades para mejorar motricidad fina

Sigue con tu lápiz las caras para unir al niño con su amiga

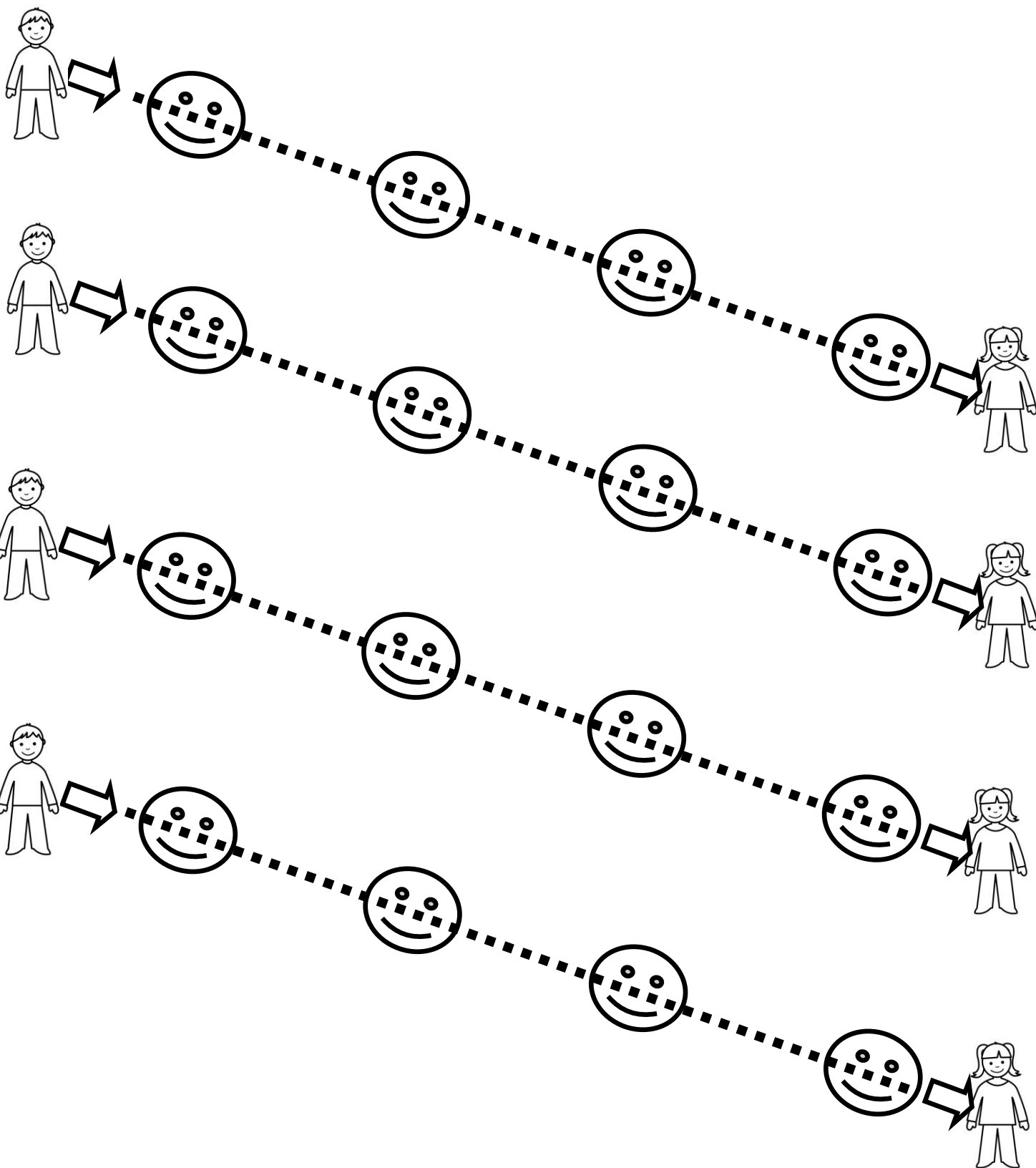

Actividades para mejorar motricidad fina

Sigue con tu lápiz las caras para unir al niño con su amiga

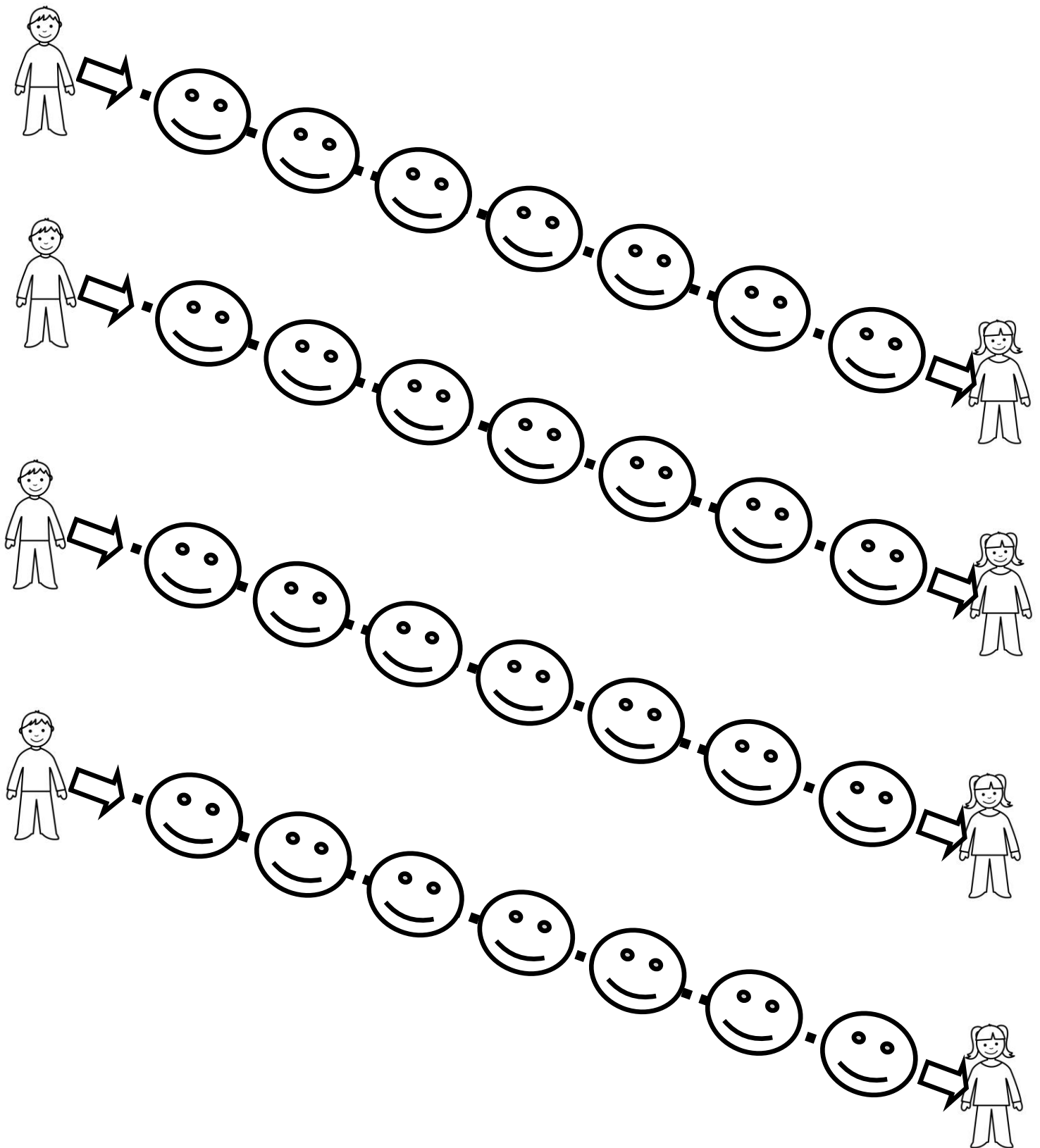

Actividades para mejorar motricidad fina

Sigue con tu lápiz las caras para unir al niño con su amiga

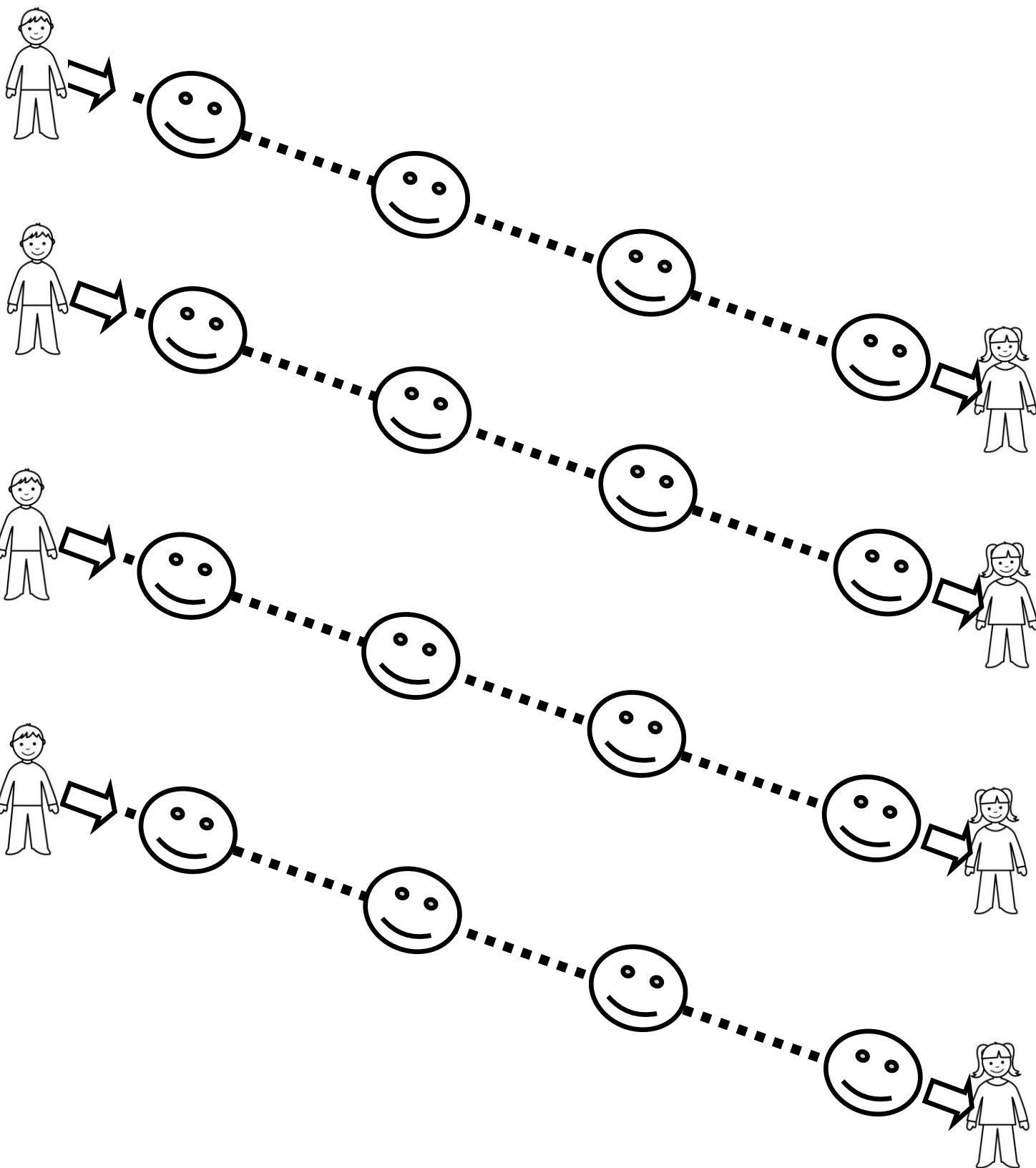

Actividades para mejorar motricidad fina

Sigue con tu lápiz las caras para unir al niño con su amiga

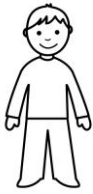
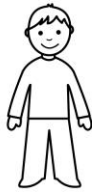
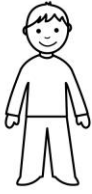

Actividades para mejorar motricidad fina

Sigue con tu lápiz las caras para unir al niño con su amiga

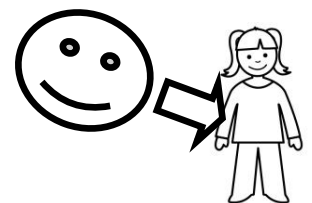
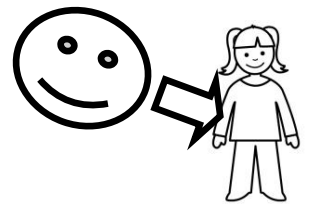
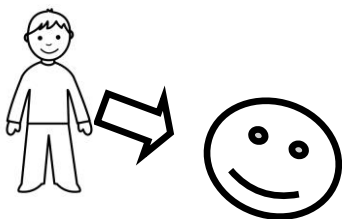
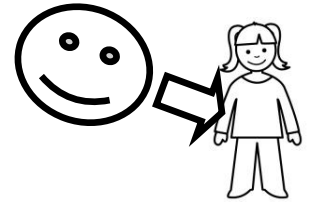
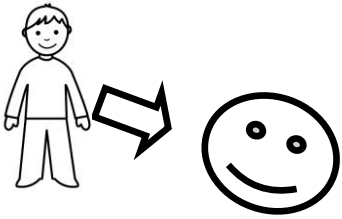
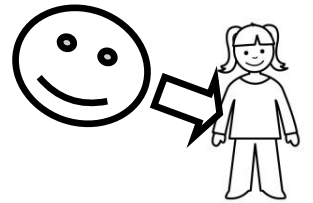
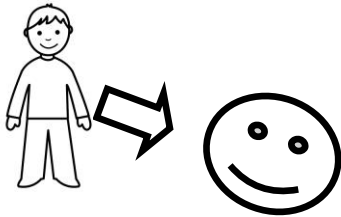
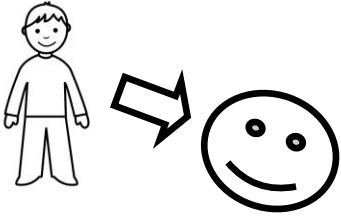

Actividades para mejorar motricidad fina

Sigue con tu lápiz los círculos para unir al niño con su pelota

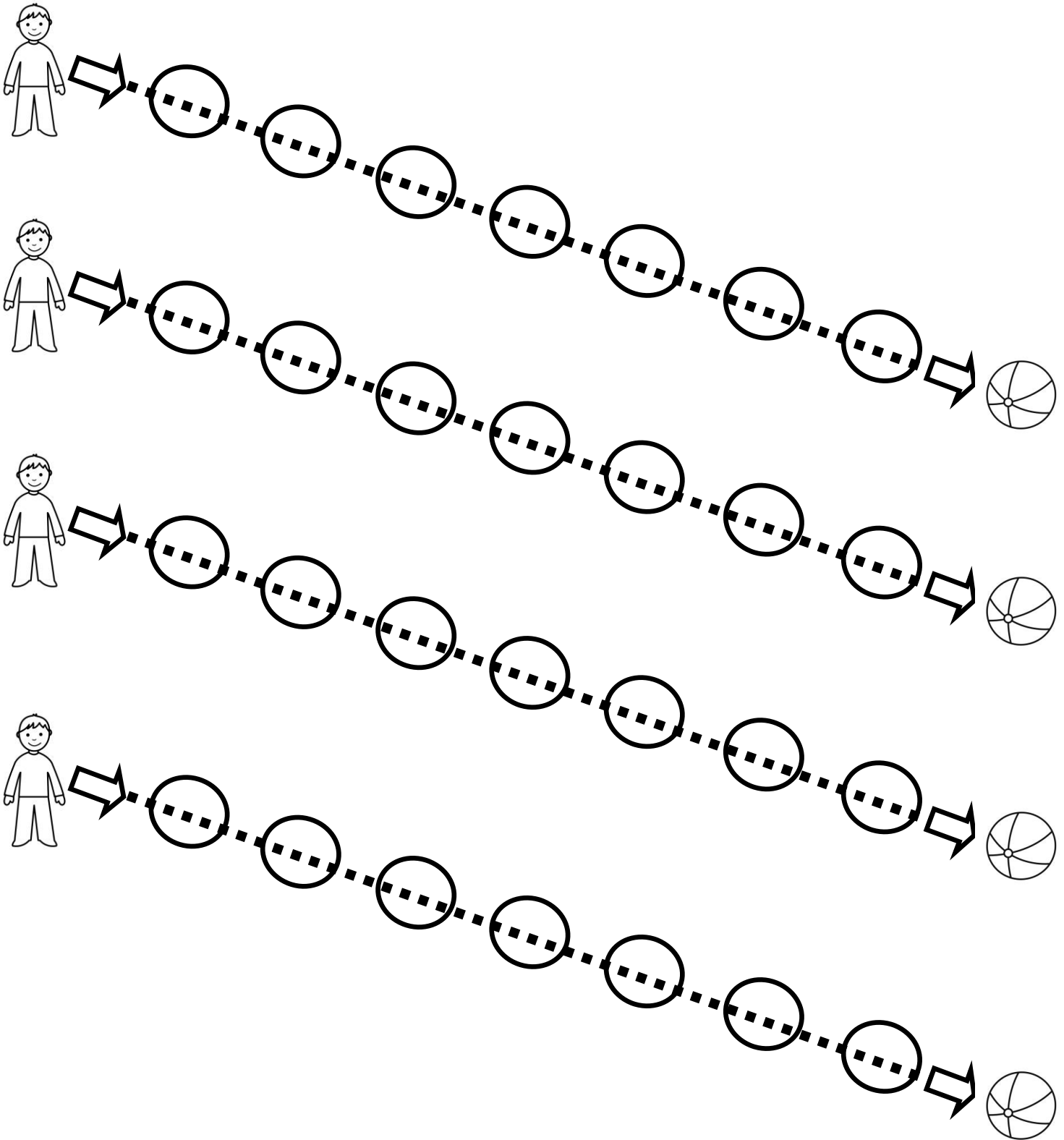

Actividades para mejorar motricidad fina

Sigue con tu lápiz los círculos para unir al niño con su pelota

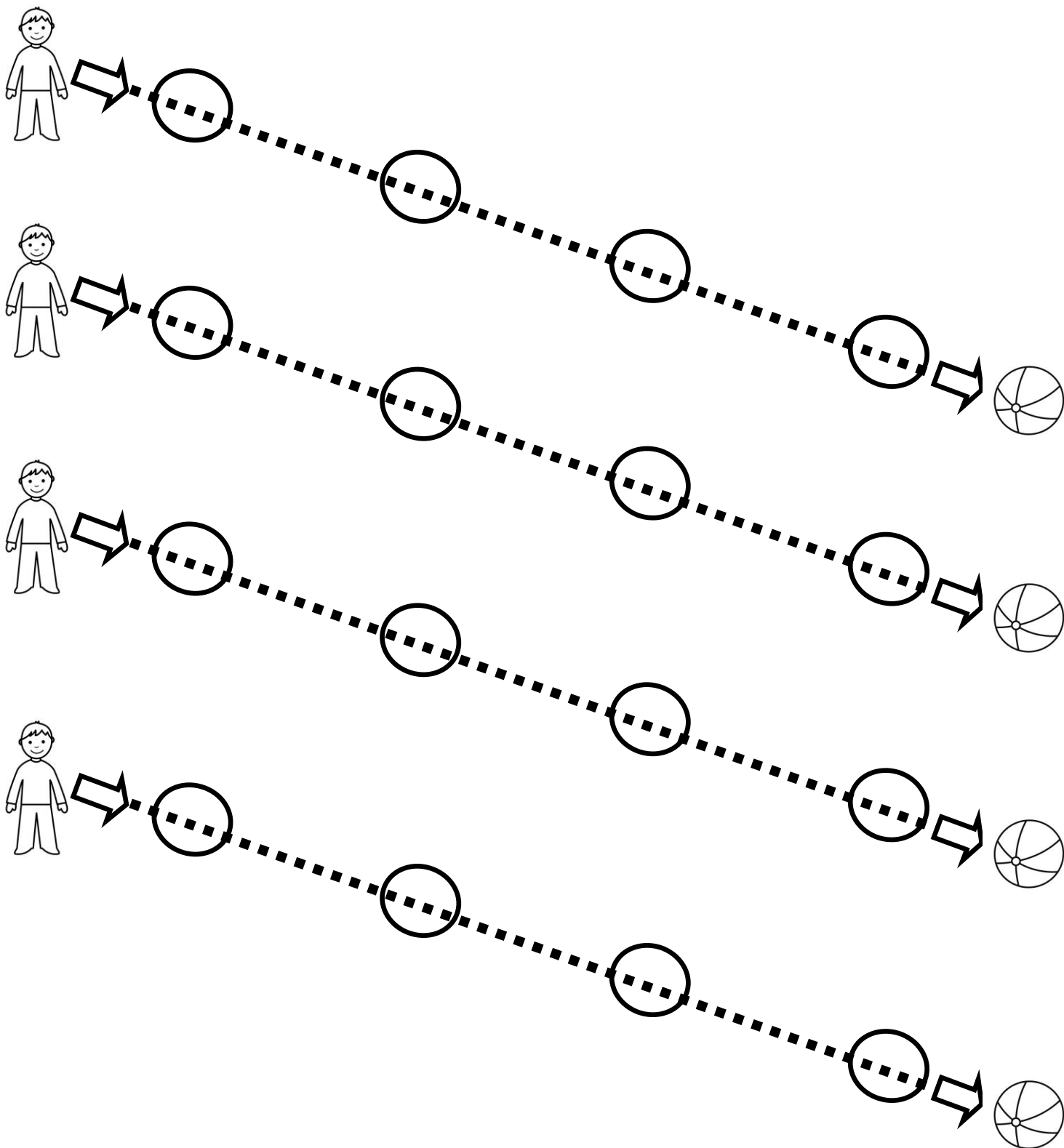

Actividades para mejorar motricidad fina

Sigue con tu lápiz los círculos para unir al niño con su pelota

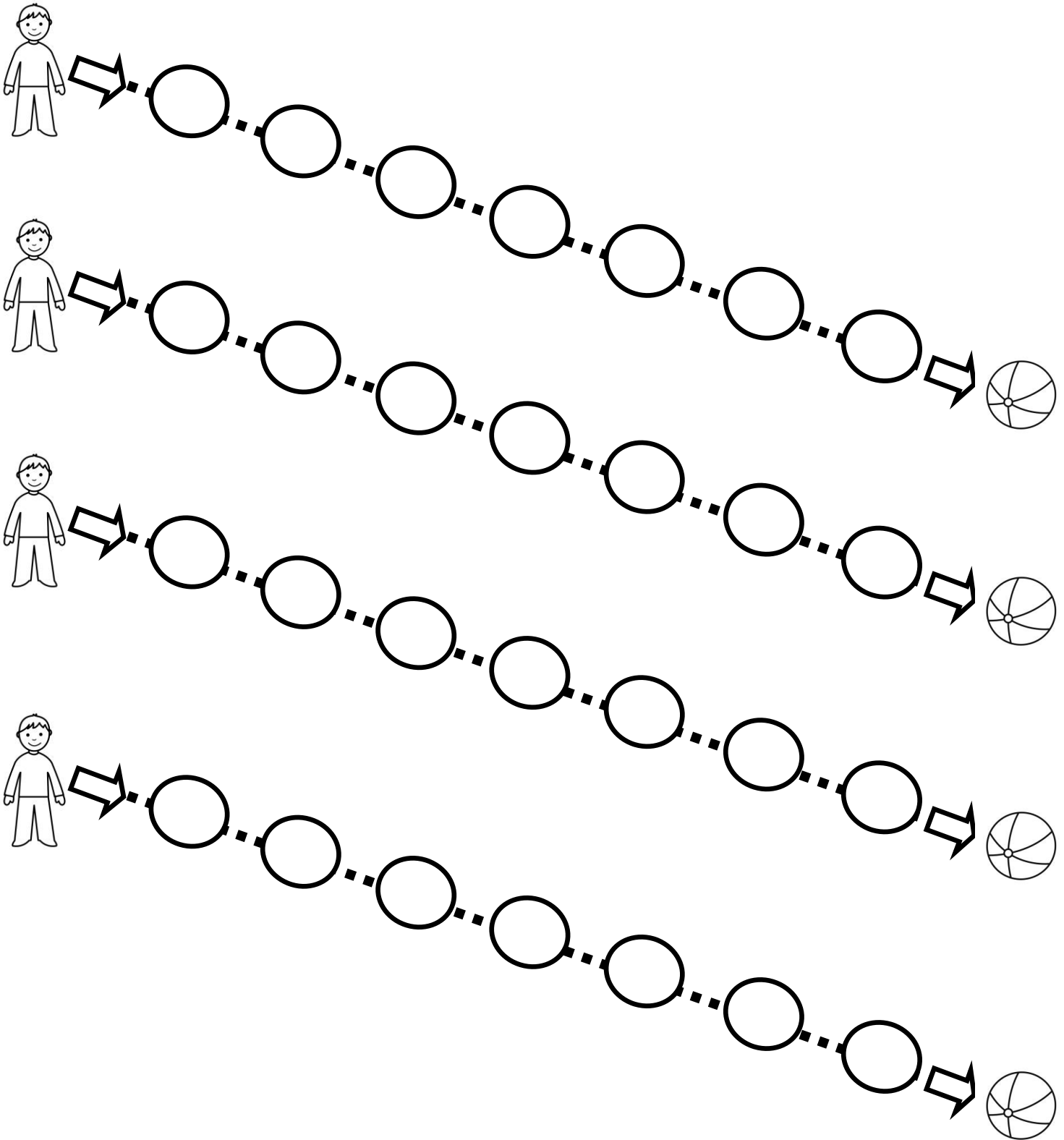

Actividades para mejorar motricidad fina

Sigue con tu lápiz los círculos para unir al niño con su pelota

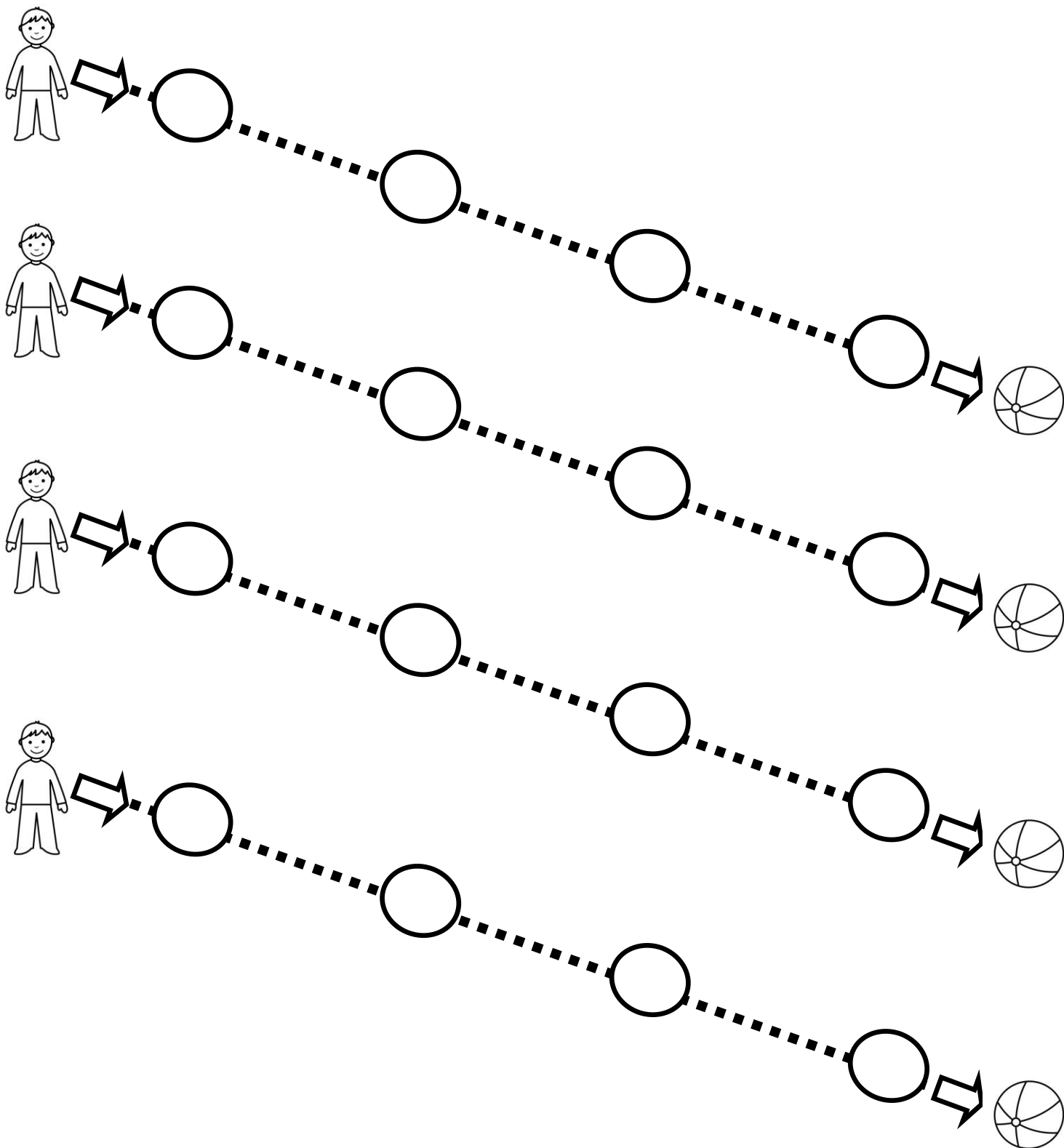

Actividades para mejorar motricidad fina

Sigue con tu lápiz los círculos para unir al niño con su pelota

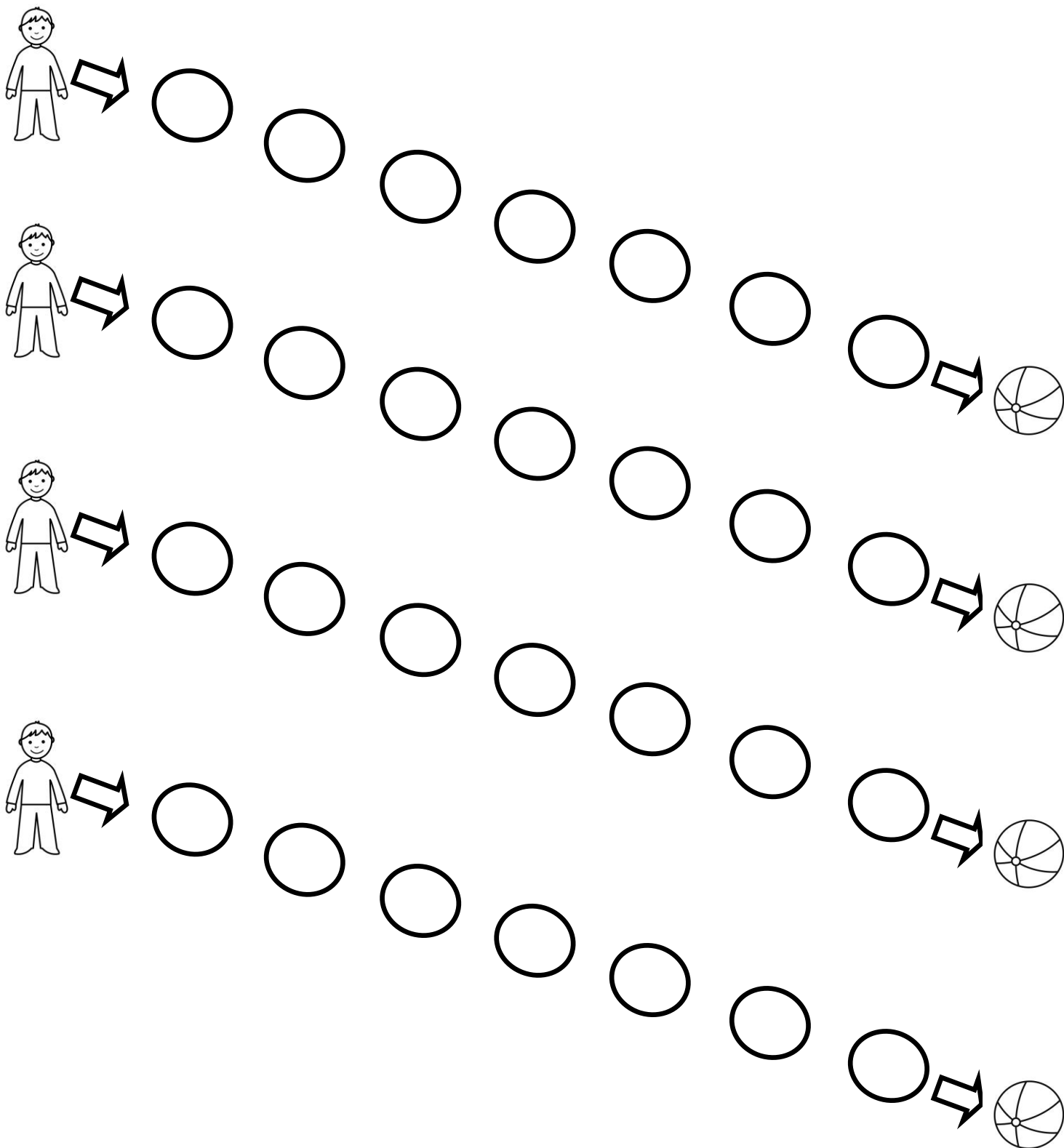

Actividades para mejorar motricidad fina

Sigue con tu lápiz los círculos para unir al niño con su pelota

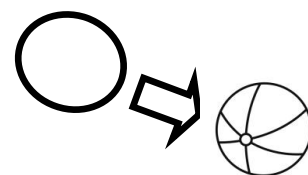
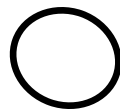
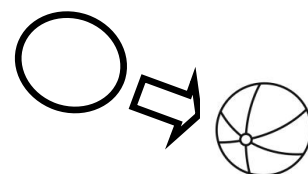
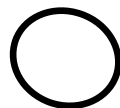
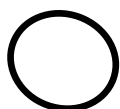
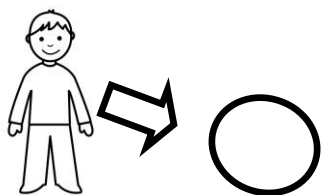
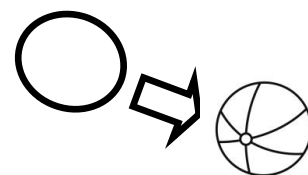
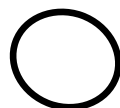
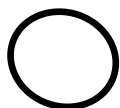
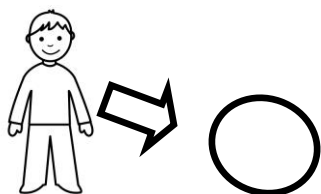
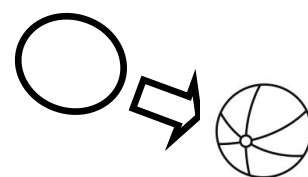
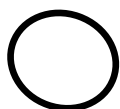
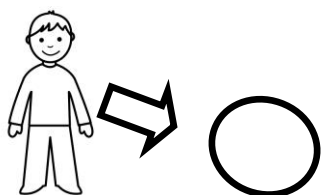
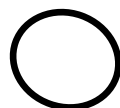
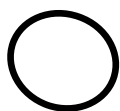
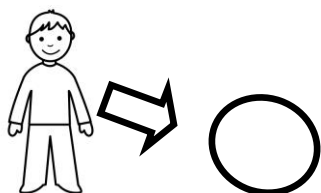

Actividades para mejorar motricidad fina

Sigue con tu lápiz las estrellitas para ir desde el sol a la tierra

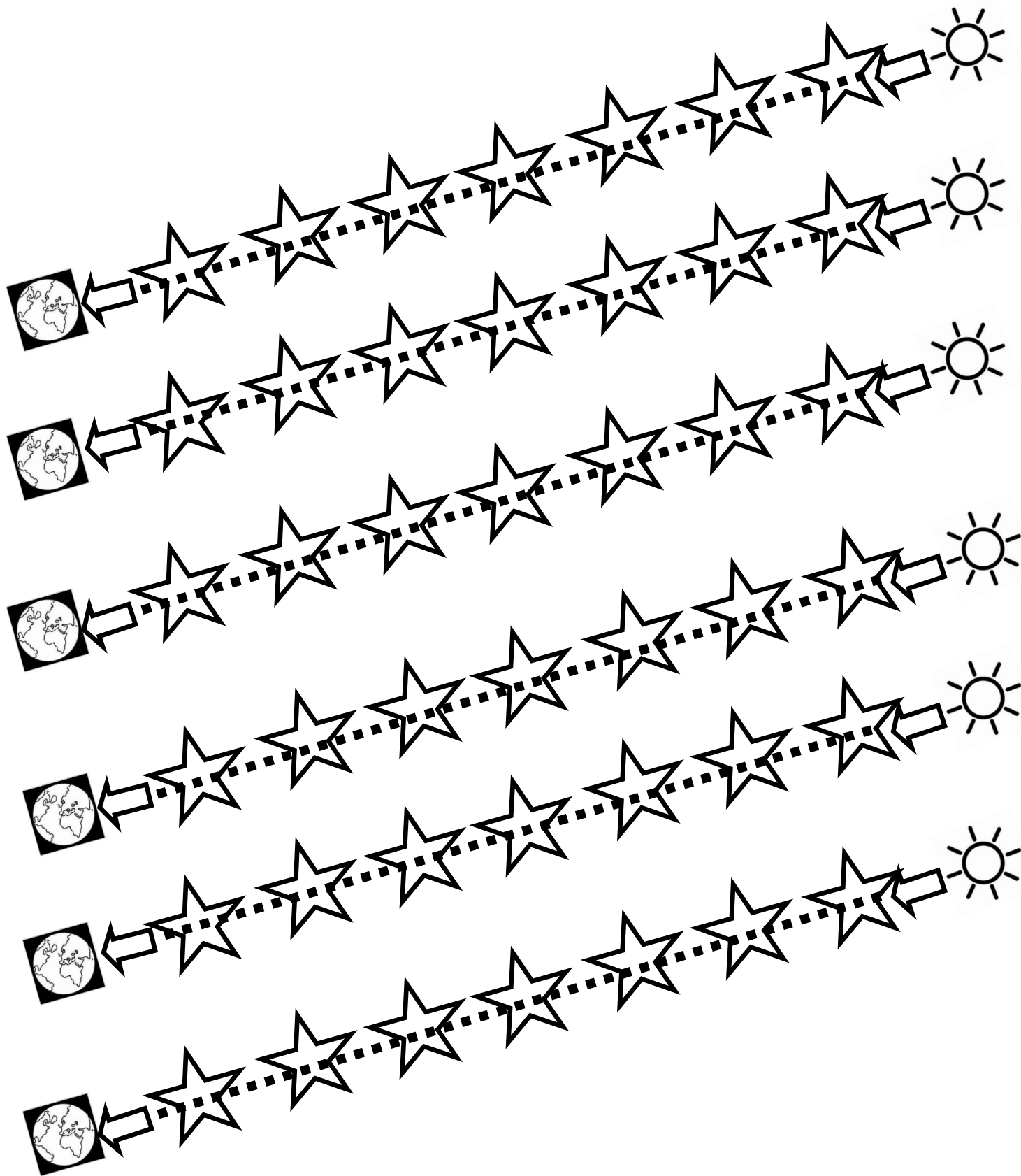

Actividades para mejorar motricidad fina

Sigue con tu lápiz las estrellitas para ir desde el sol a la tierra

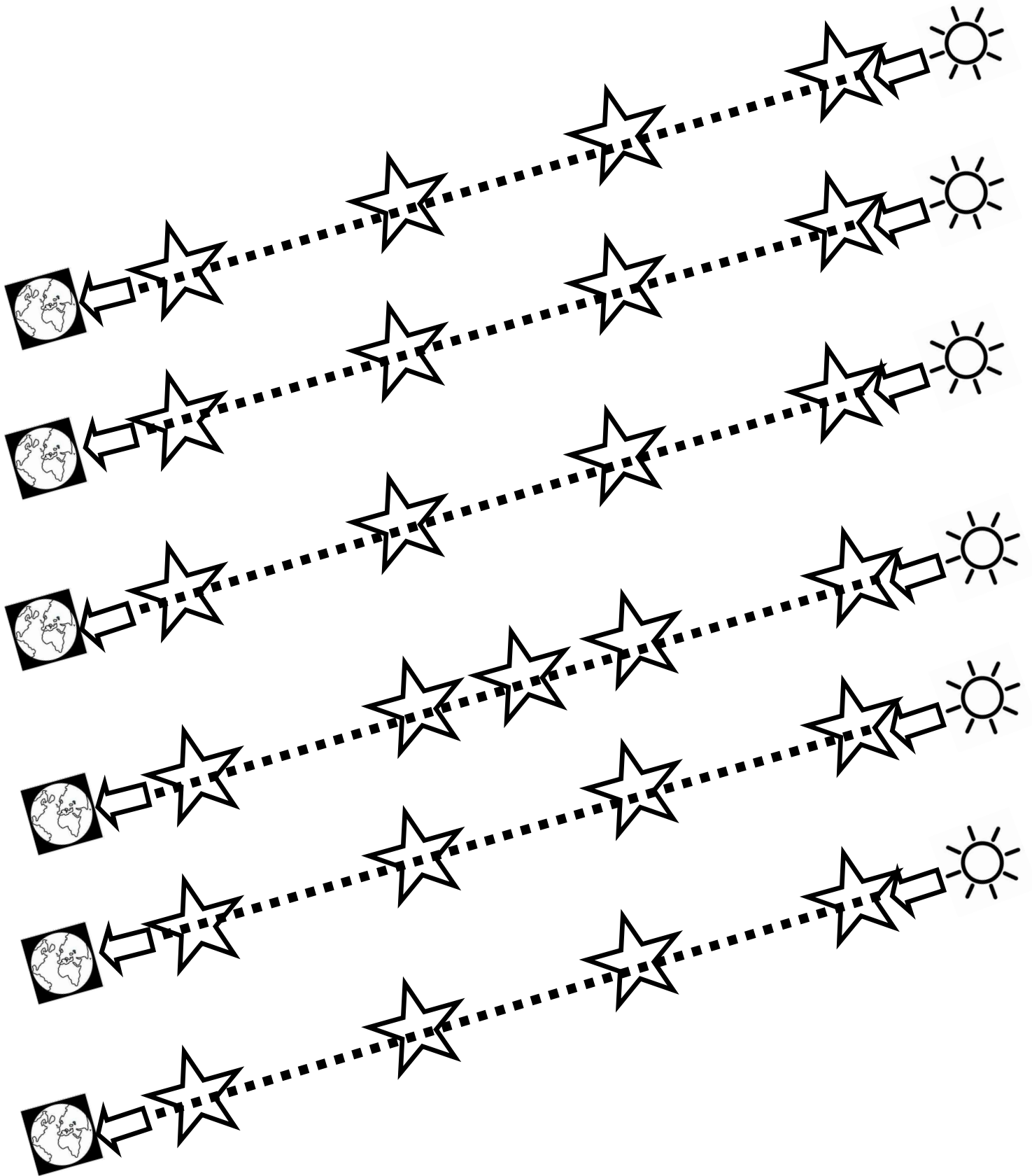

Actividades para mejorar motricidad fina

Sigue con tu lápiz las estrellitas para ir desde el sol a la tierra

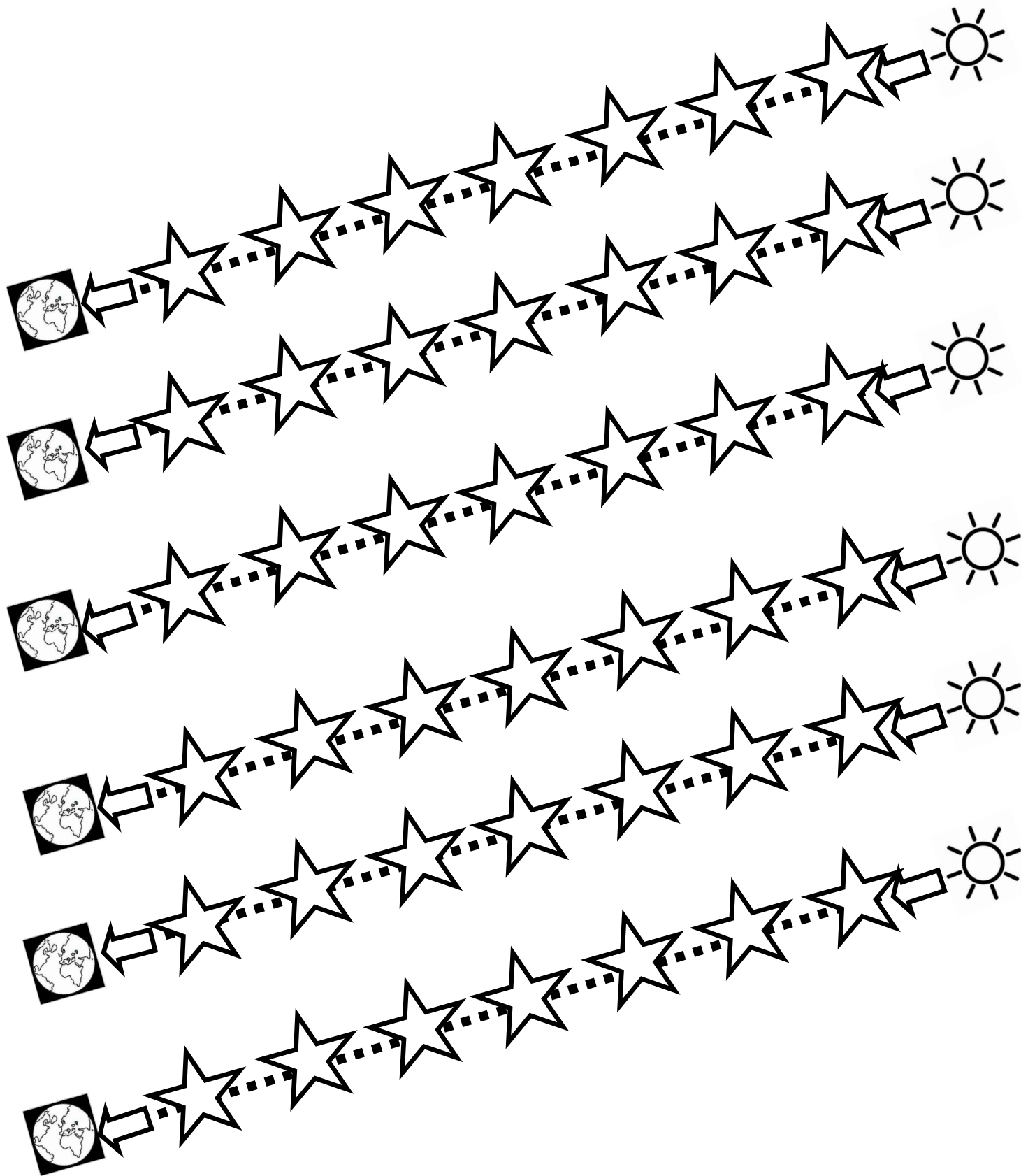

Actividades para mejorar motricidad fina

Sigue con tu lápiz las estrellitas para ir desde el sol a la tierra

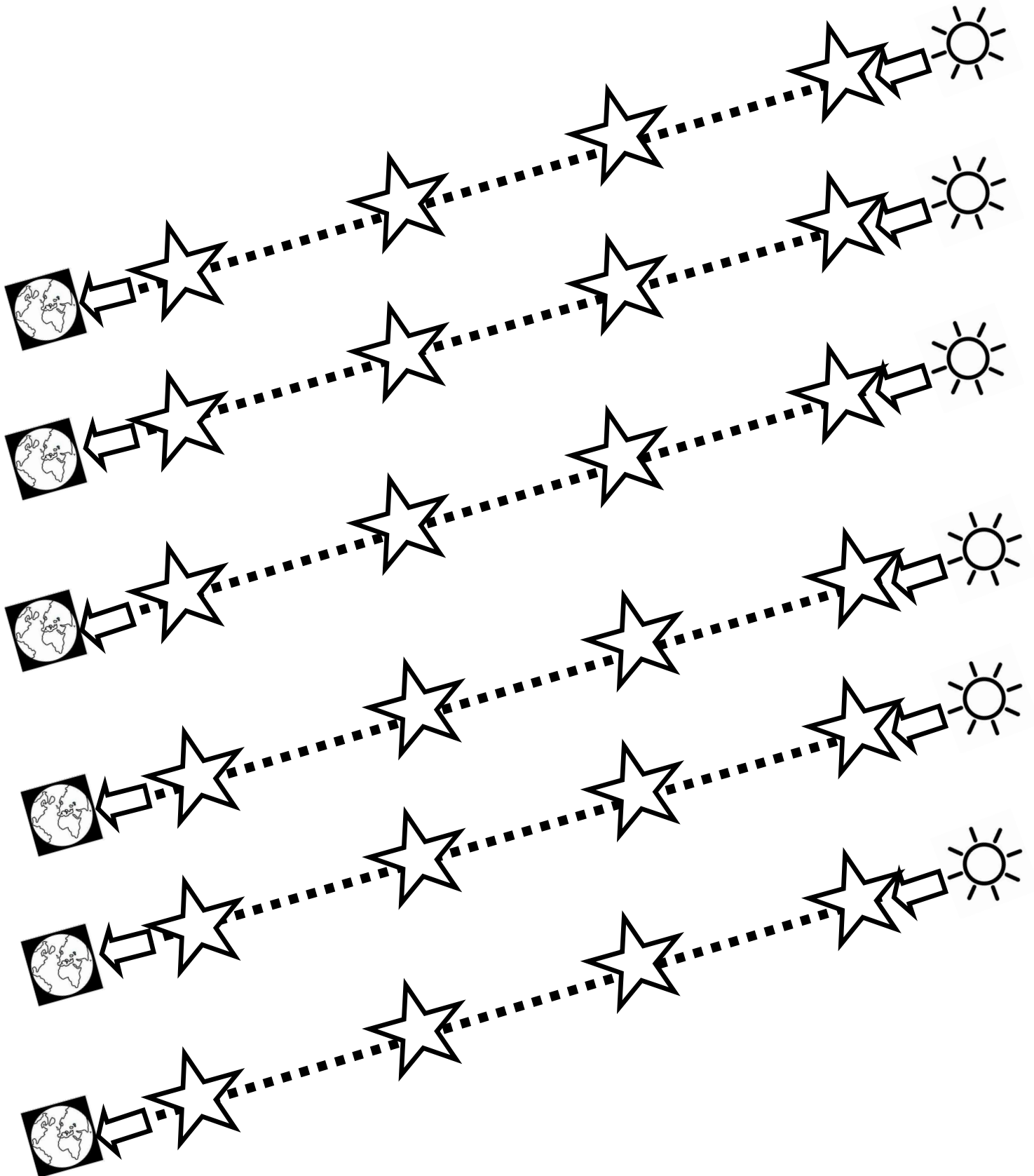

Actividades para mejorar motricidad fina

Sigue con tu lápiz las estrellitas para ir desde el sol a la tierra

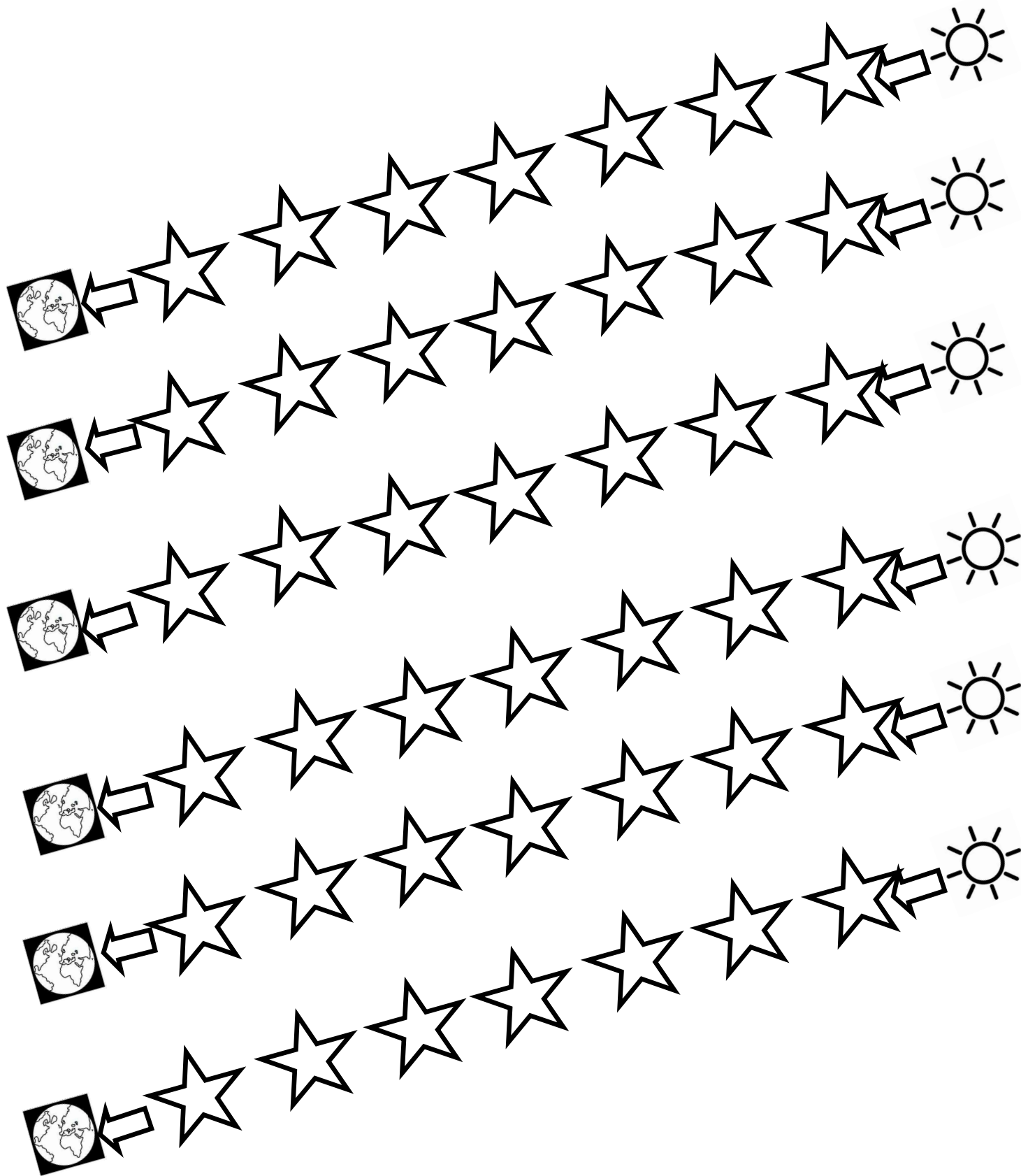

Actividades para mejorar motricidad fina

Sigue con tu lápiz las estrellitas para ir desde el sol a la tierra

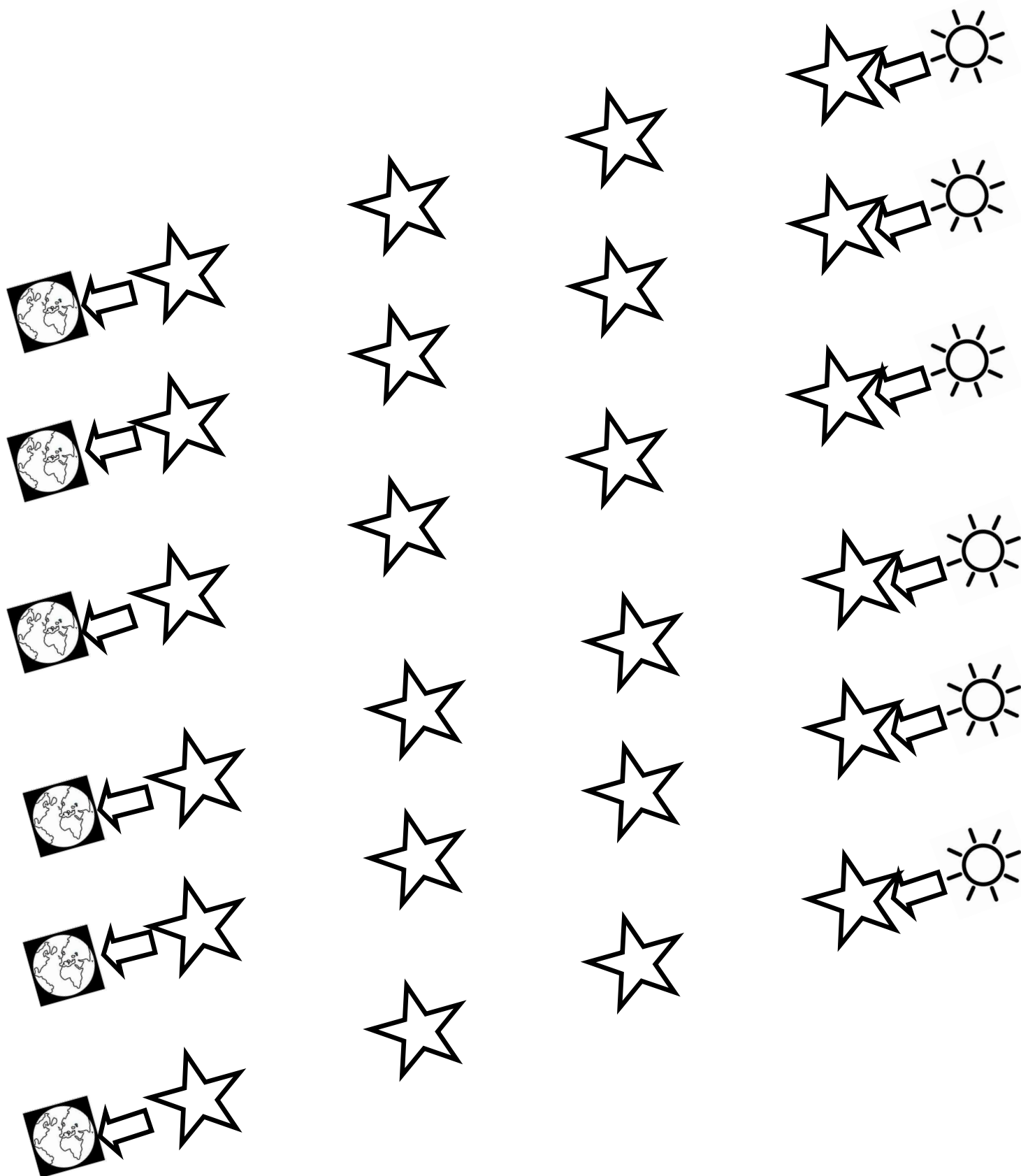

Actividades para mejorar motricidad fina

Sigue con tu lápiz los corazones para unir a la mama y a su bebe

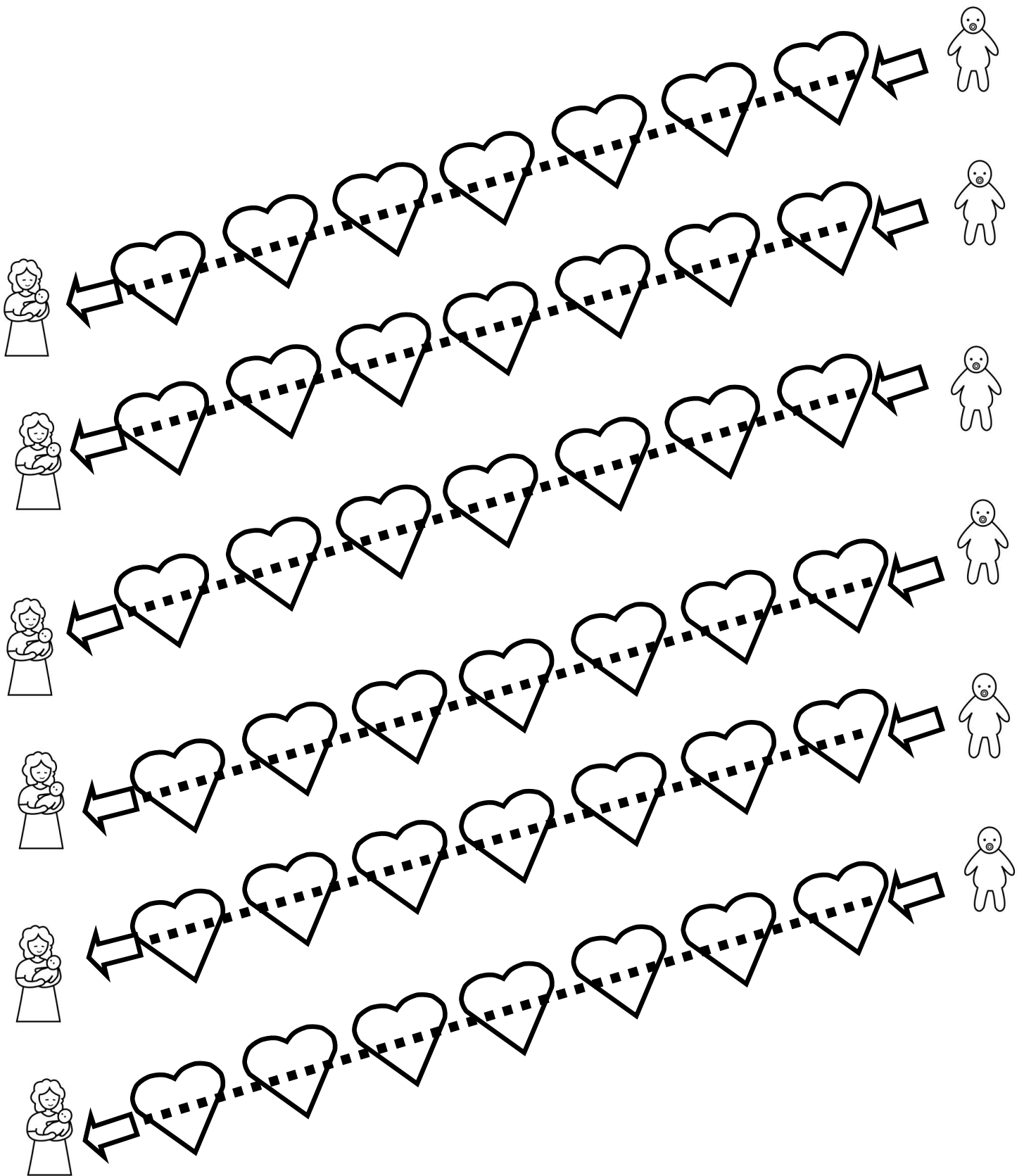

Actividades para mejorar motricidad fina

Sigue con tu lápiz los corazones para unir a la mama y a su bebe

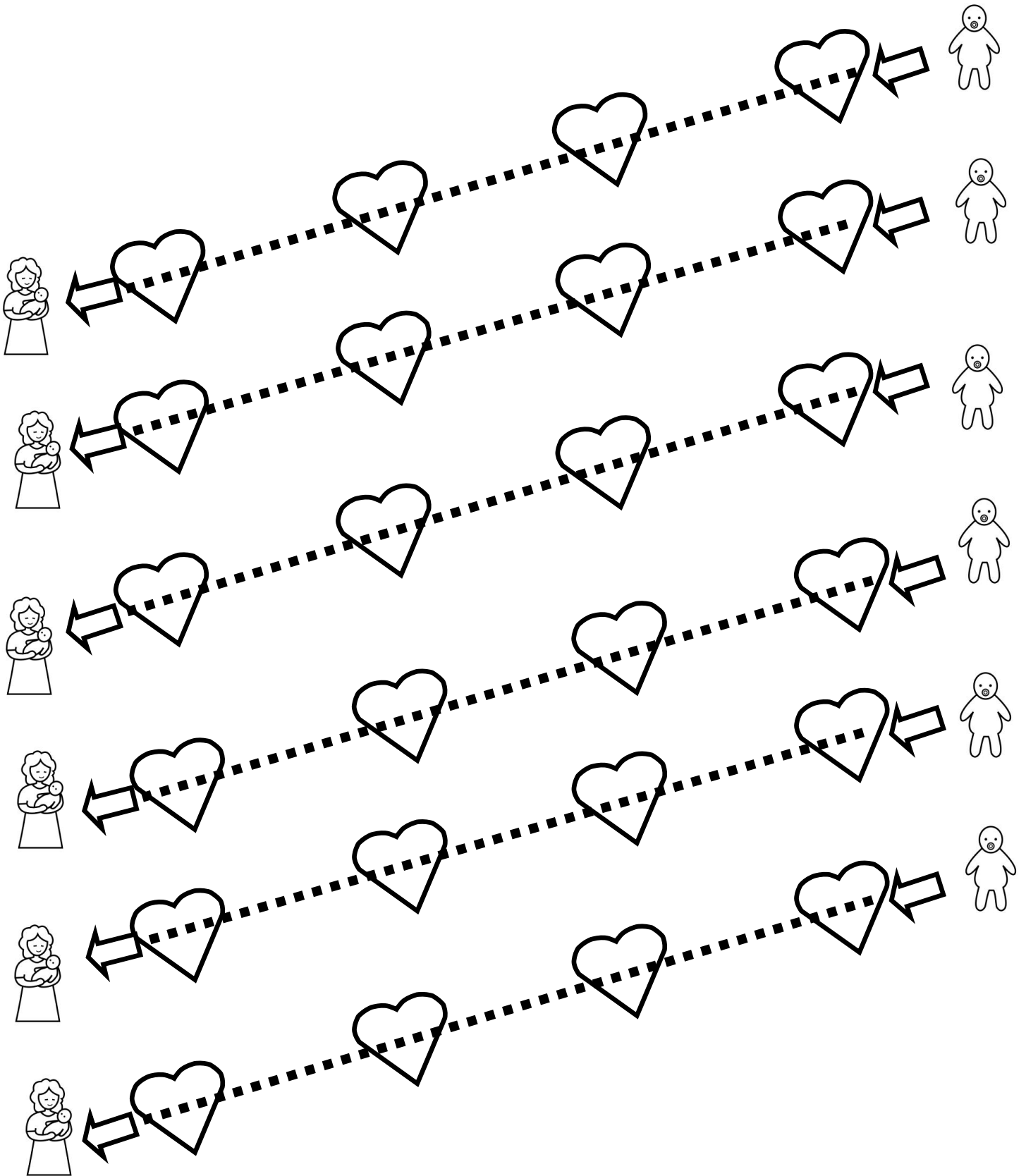

Actividades para mejorar motricidad fina

Sigue con tu lápiz los corazones para unir a la mama y a su bebe

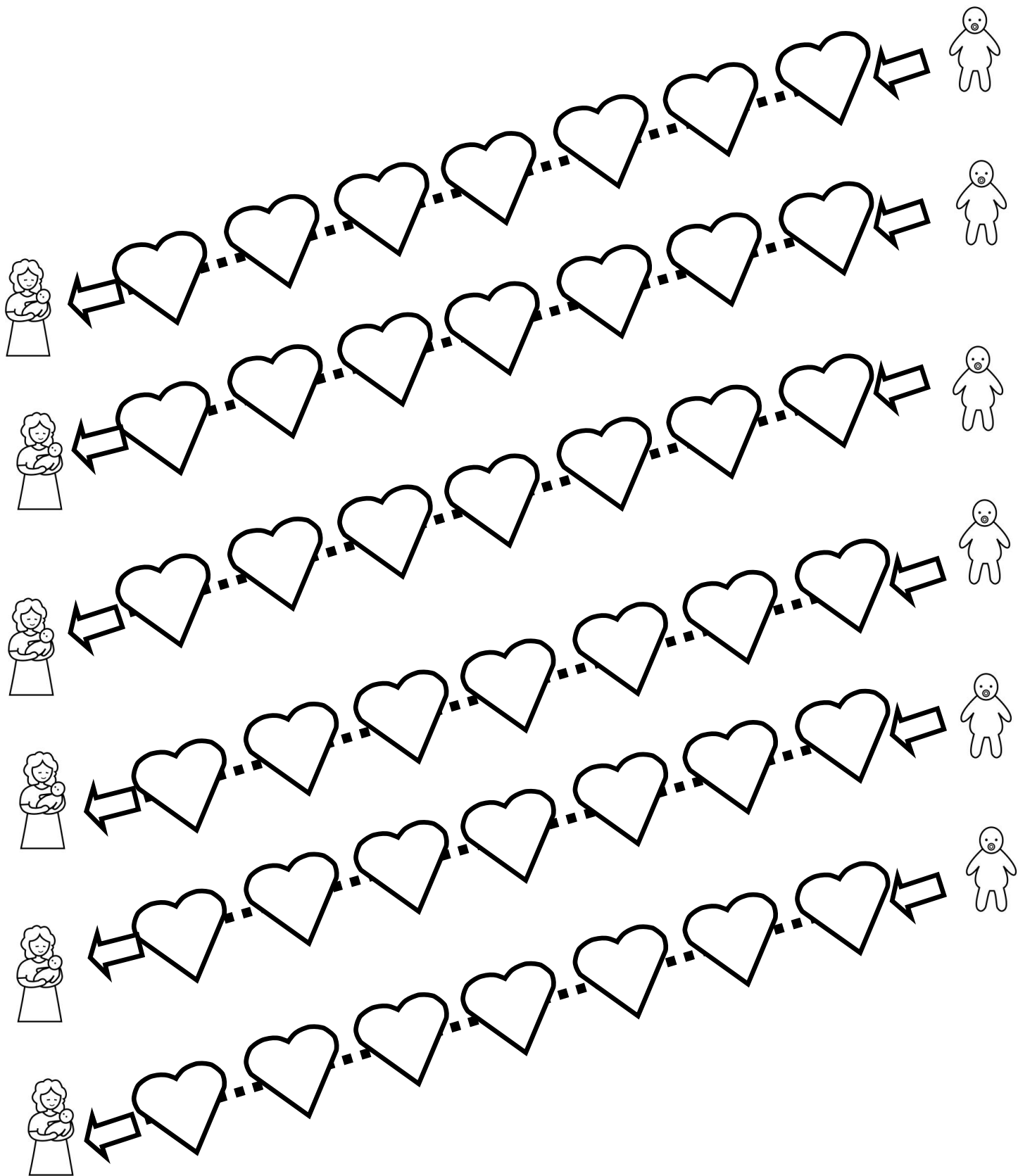

Actividades para mejorar motricidad fina

Sigue con tu lápiz los corazones para unir a la mama y a su bebe

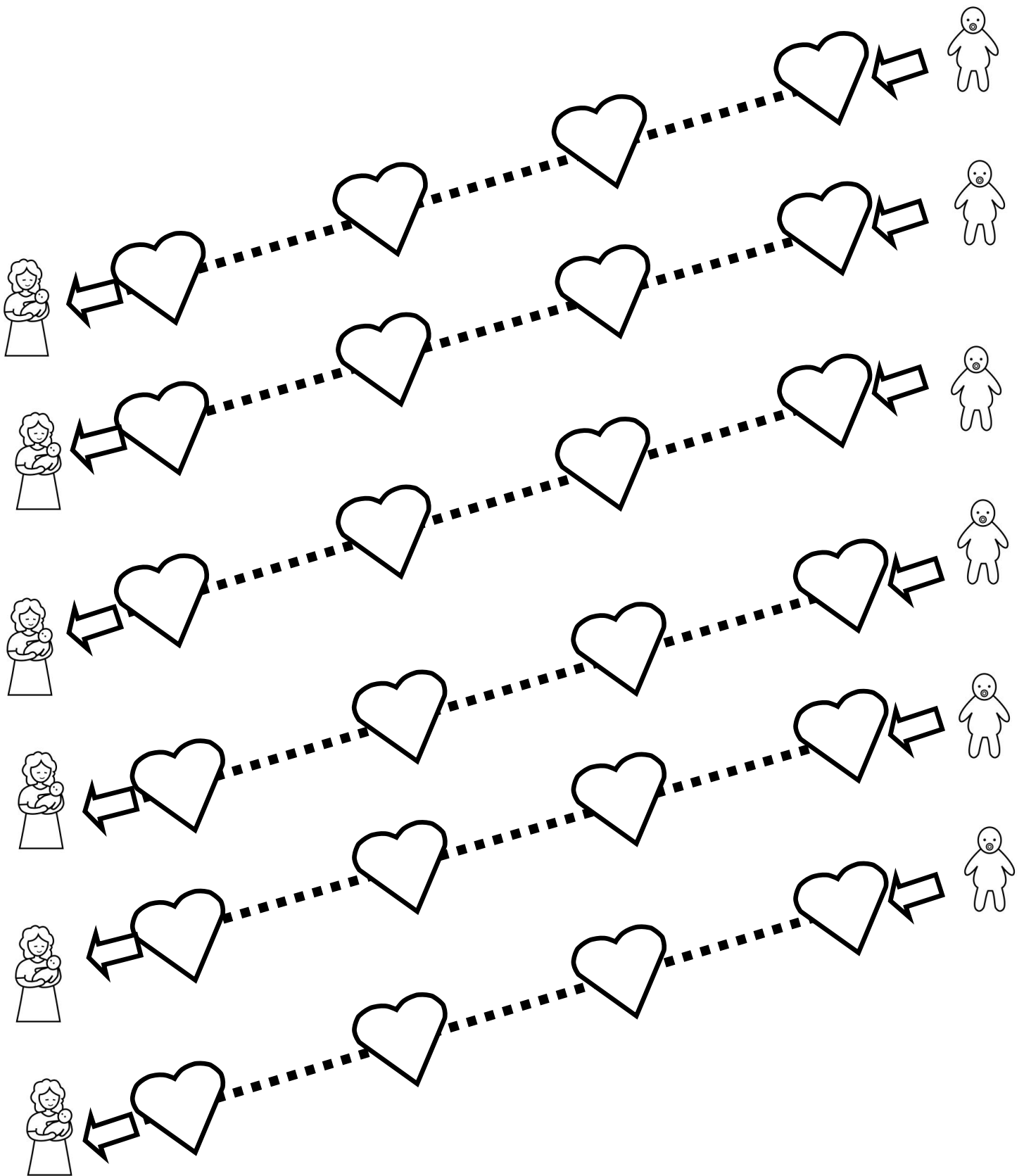

Actividades para mejorar motricidad fina

Sigue con tu lápiz los corazones para unir a la mama y a su bebe

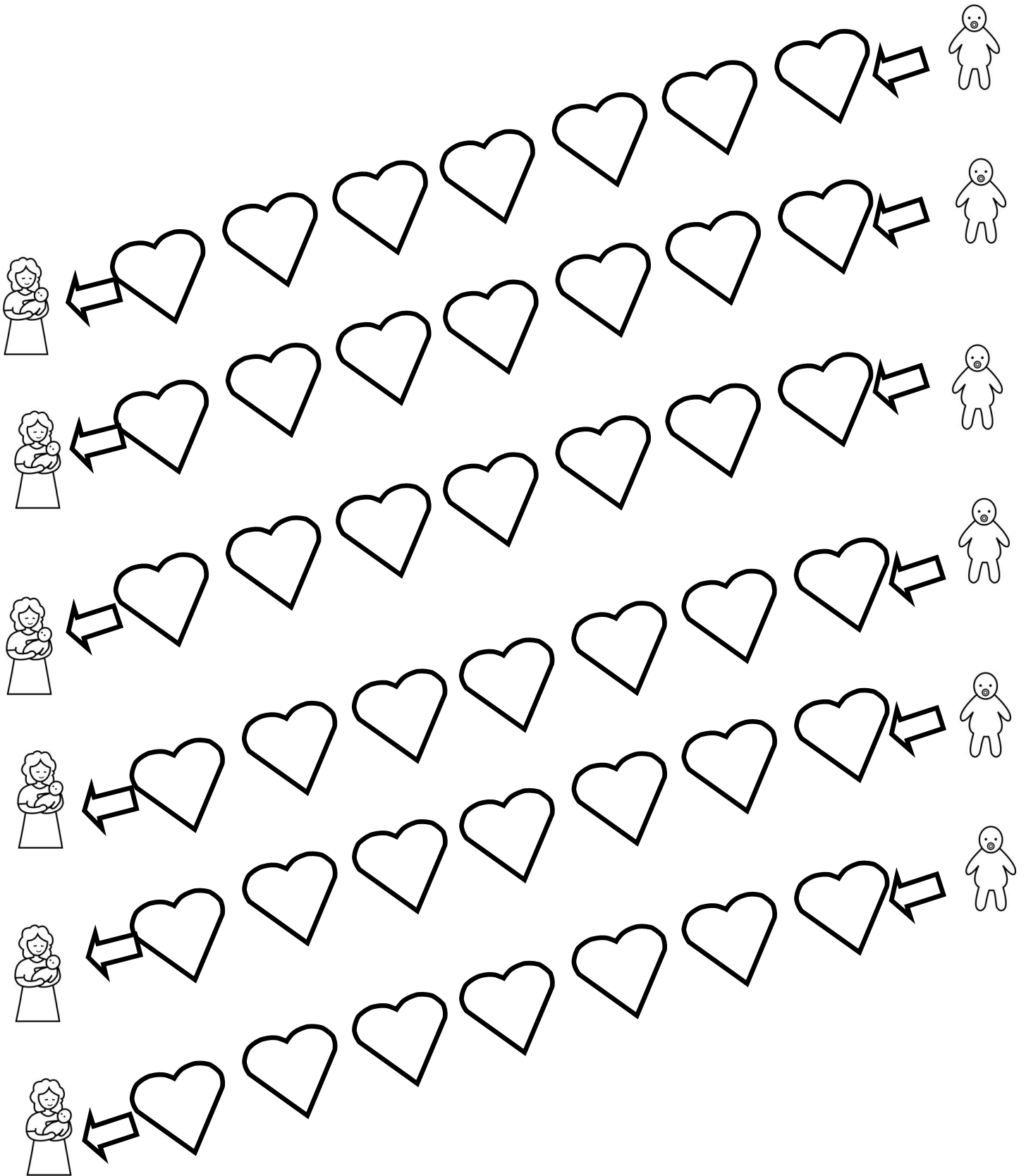

Actividades para mejorar motricidad fina

Sigue con tu lápiz los corazones para unir a la mama y a su bebe

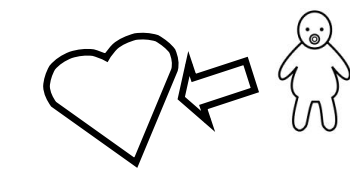
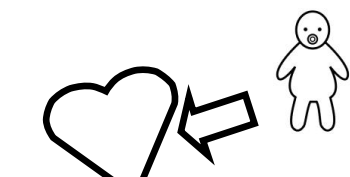
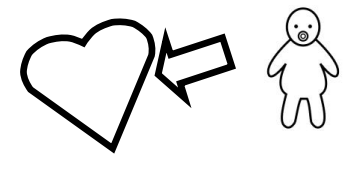
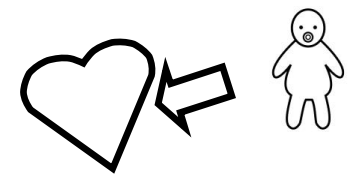
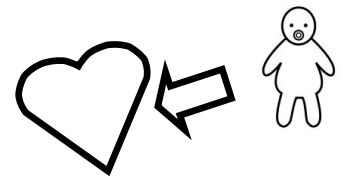
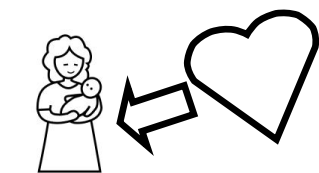
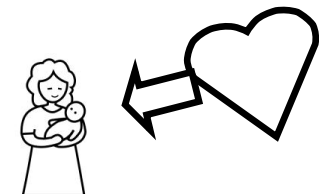
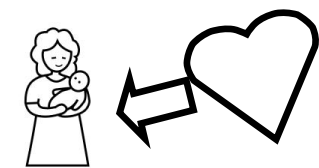
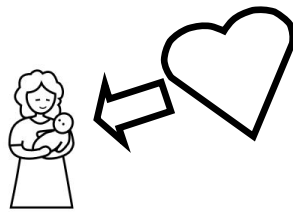
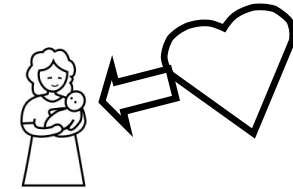
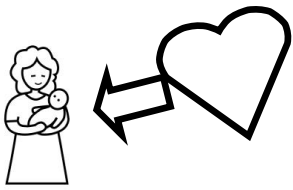

Actividades para mejorar motricidad fina

Sigue con tu lápiz las caras para unir al niño con su amiga

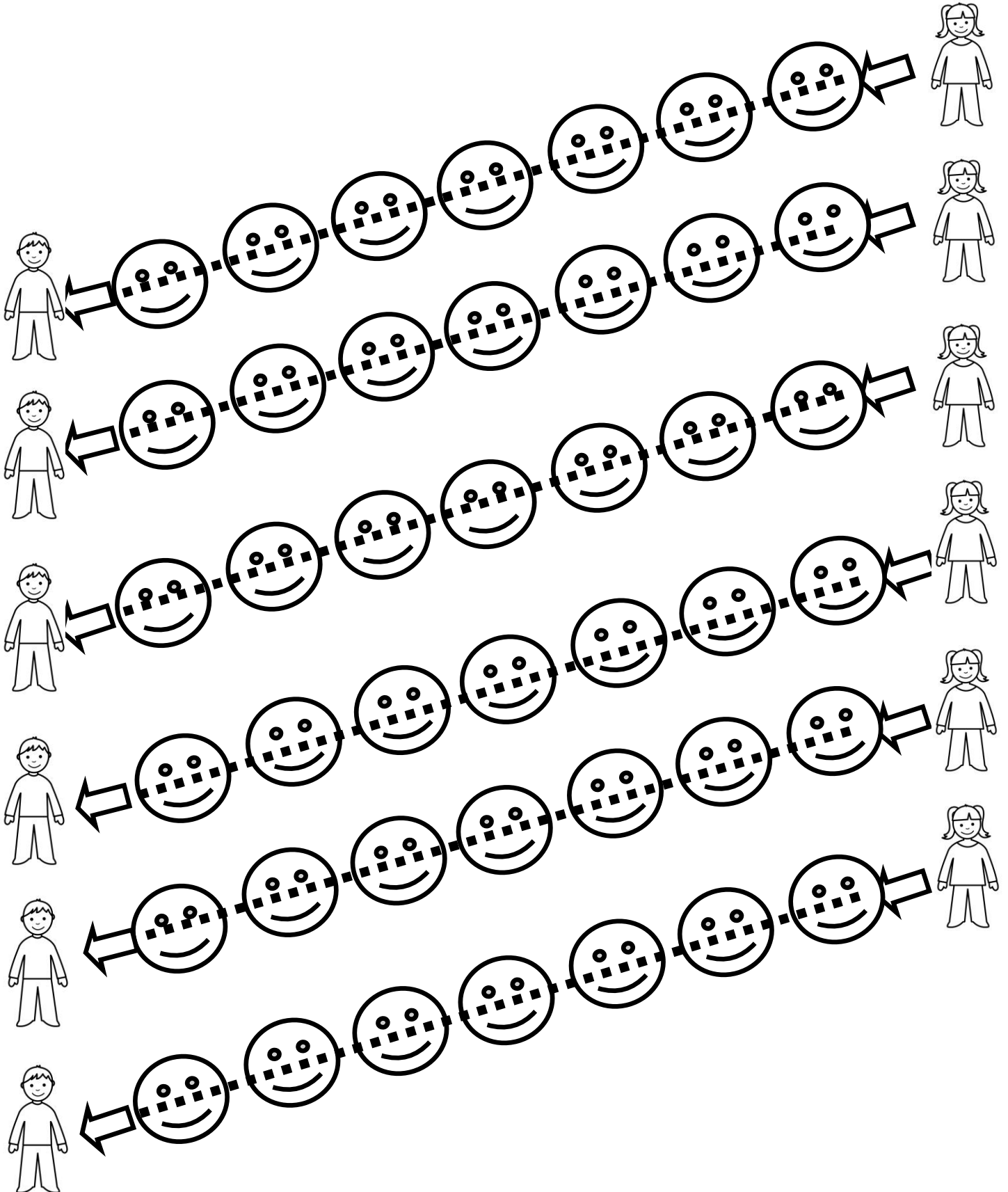

Actividades para mejorar motricidad fina

Sigue con tu lápiz las caras para unir al niño con su amiga

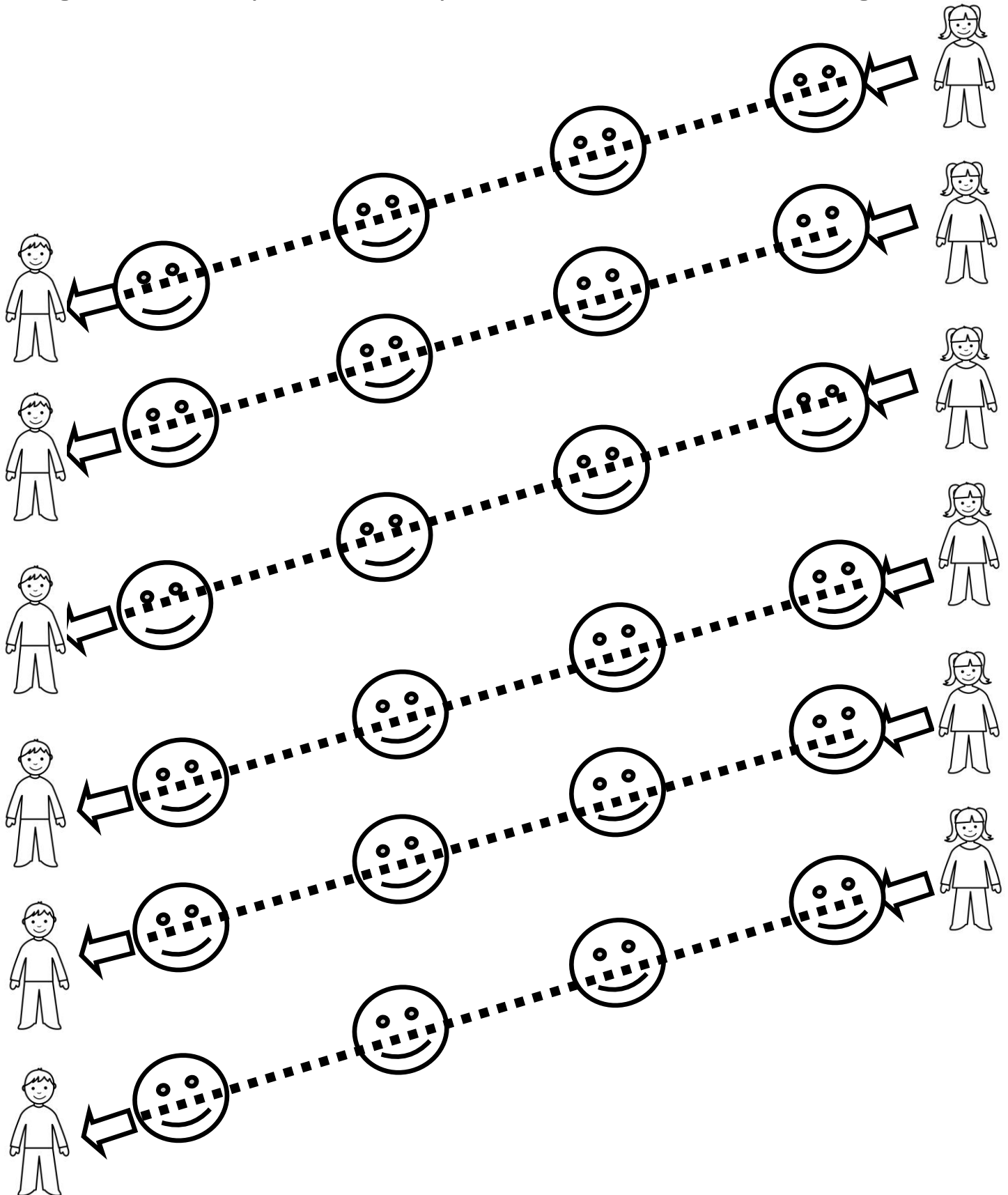

Actividades para mejorar motricidad fina

Sigue con tu lápiz las caras para unir al niño con su amiga

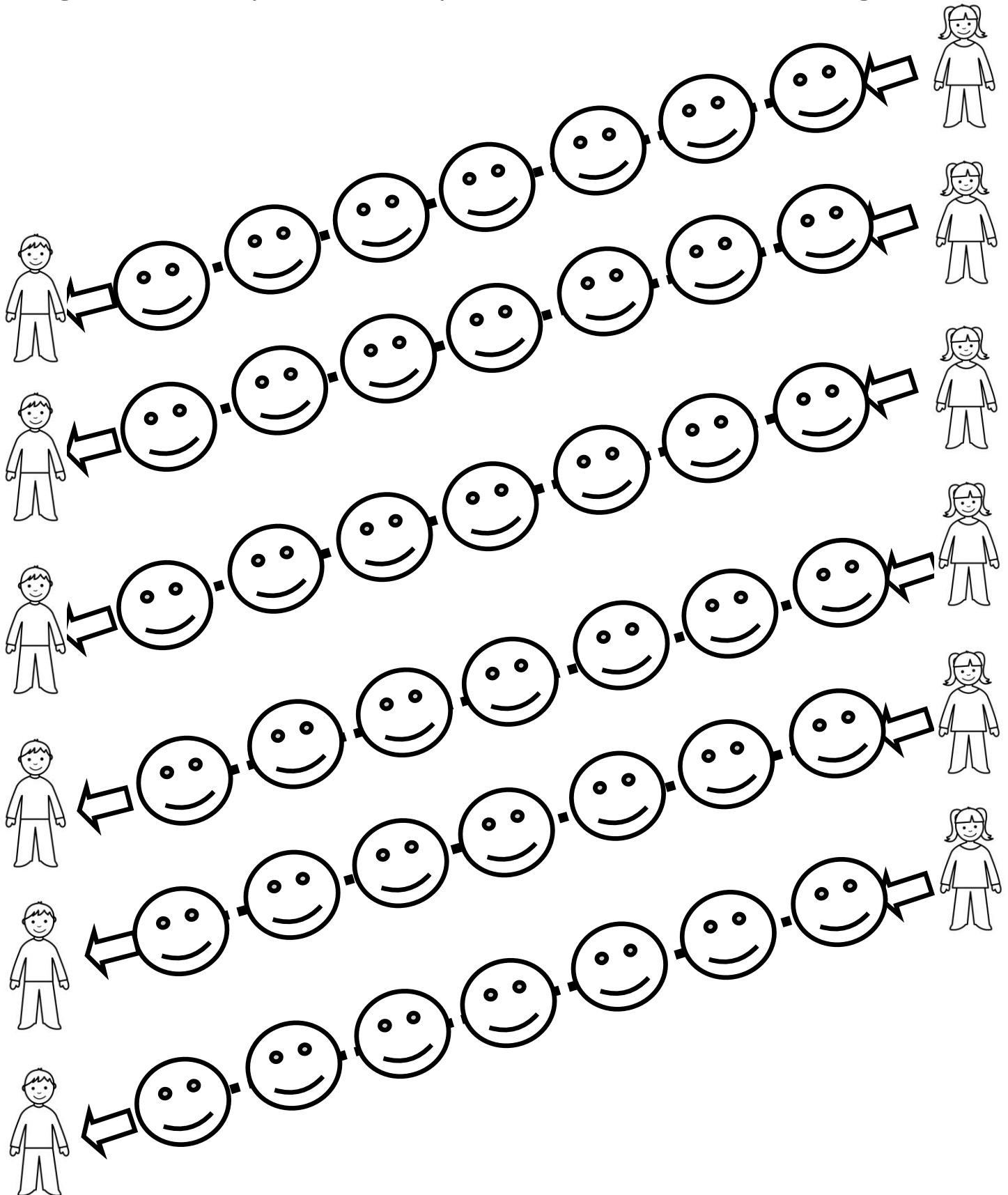

Actividades para mejorar motricidad fina

Sigue con tu lápiz las caras para unir al niño con su amiga

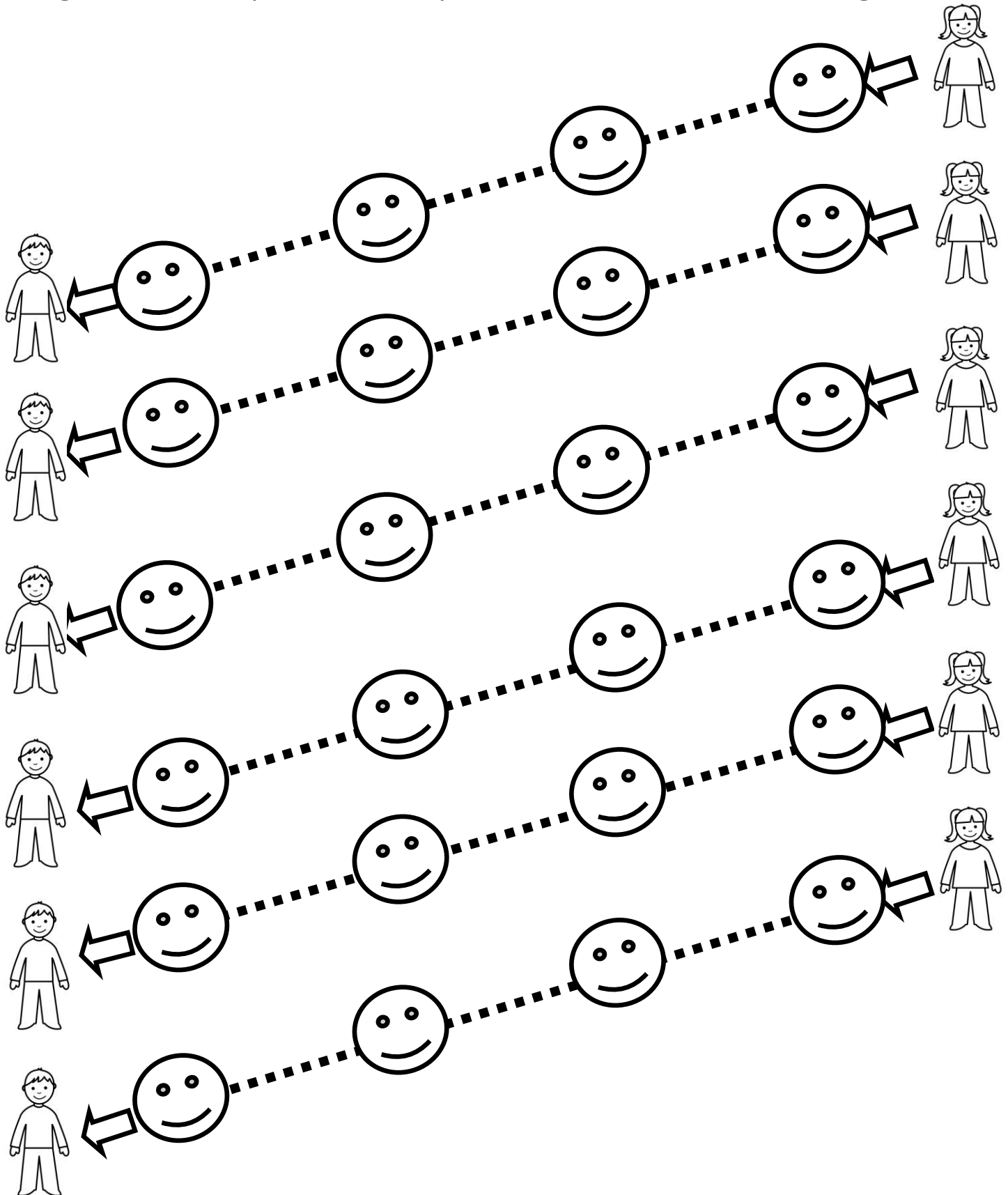

Actividades para mejorar motricidad fina

Sigue con tu lápiz las caras para unir al niño con su amiga

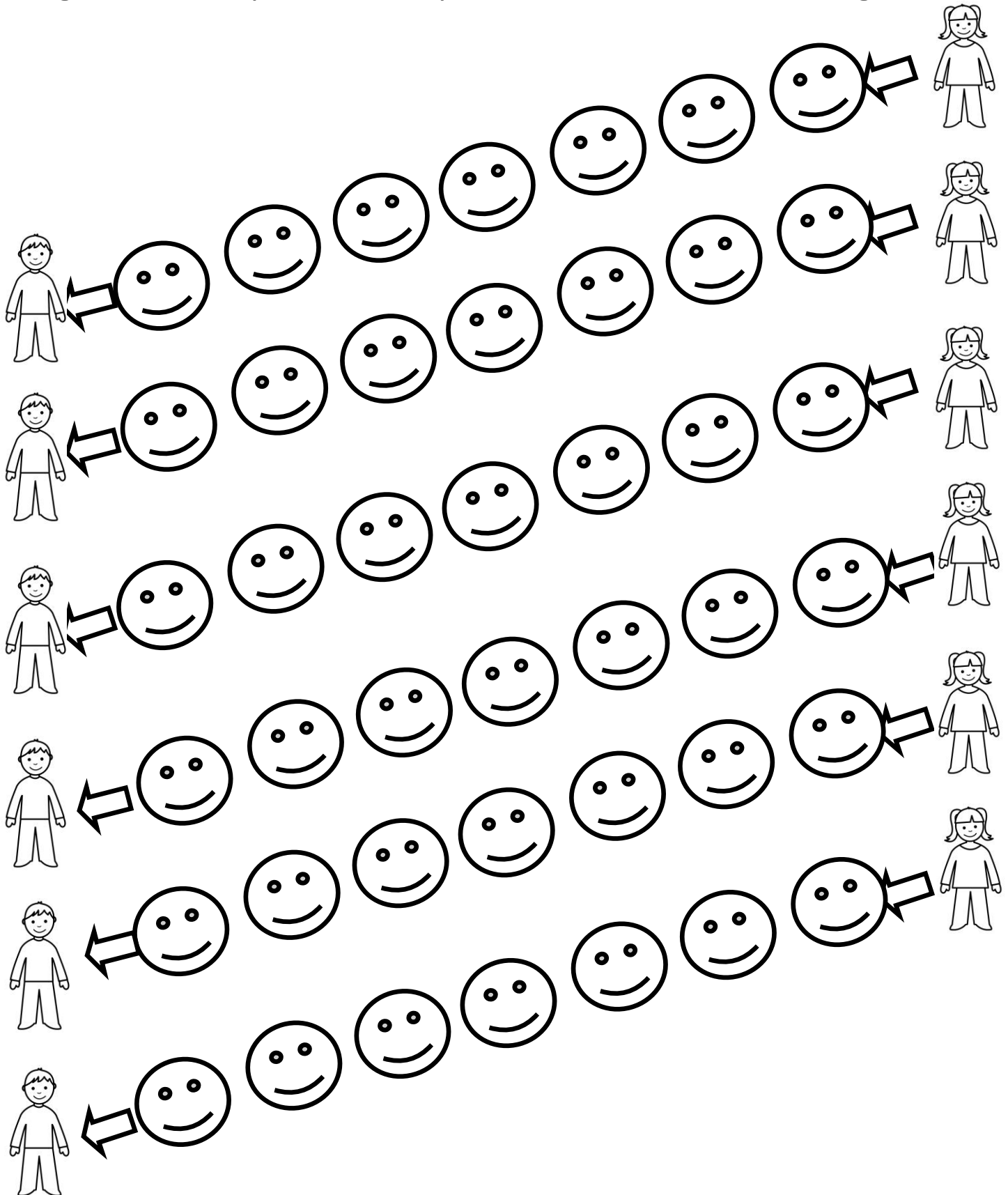

Actividades para mejorar motricidad fina

Sigue con tu lápiz las caras para unir al niño con su amiga

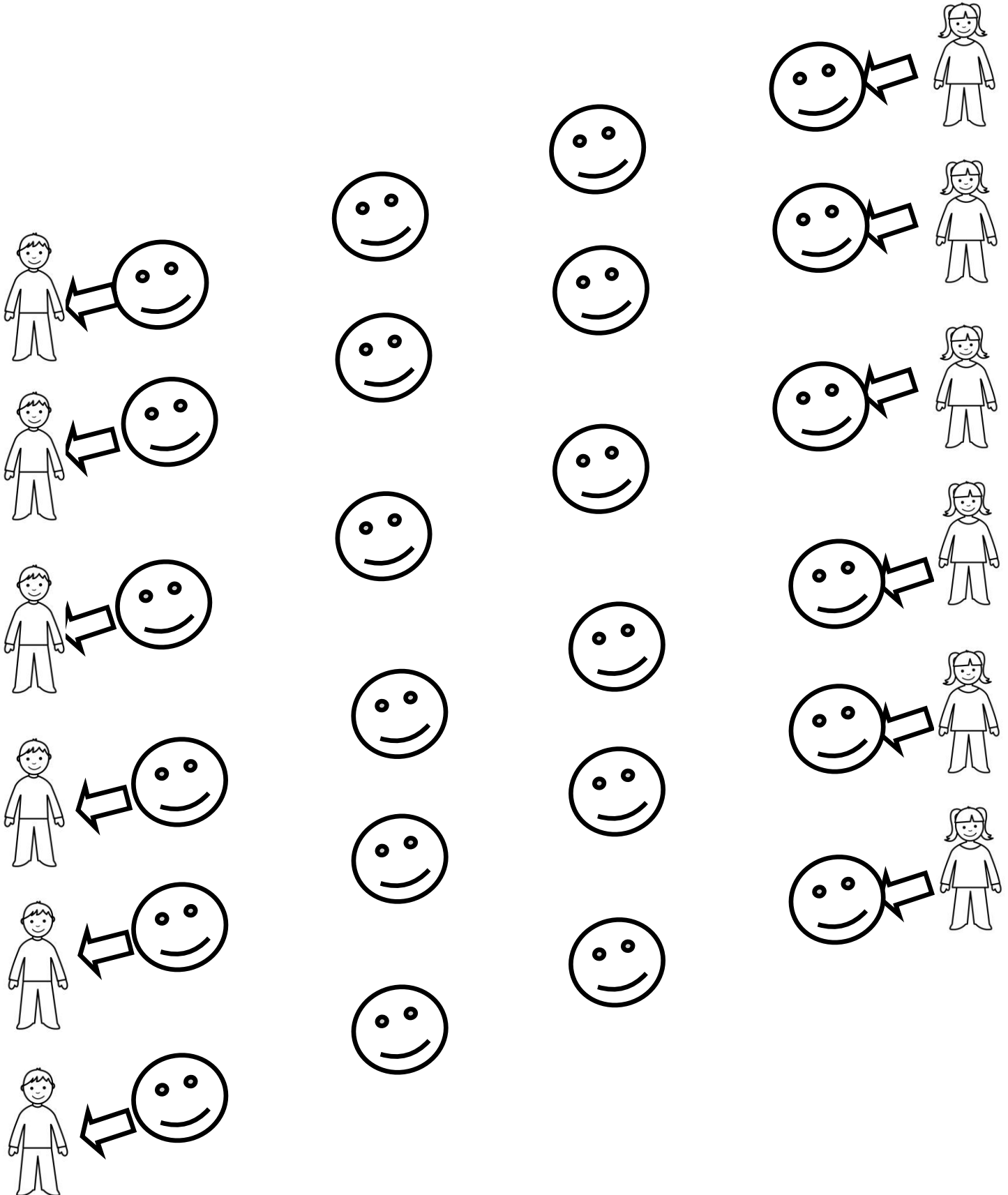

Actividades para mejorar motricidad fina

Sigue con tu lápiz los círculos para unir al niño con su pelota

The worksheet contains six identical rows. Each row begins on the left with a ball icon. A dashed line starts from the ball and zig-zags through a series of seven circles. The path ends on the right with a boy icon. The circles are arranged in a zig-zag pattern: the first circle is to the right of the ball, the second is to the left, the third is to the right, and so on. The dashed line connects the center of each circle to the center of the next one. The boy icon is positioned to the right of the final circle in each row.

Actividades para mejorar motricidad fina

Sigue con tu lápiz los círculos para unir al niño con su pelota

The worksheet contains seven identical rows. Each row is designed for a tracing activity. On the far left of each row is a ball. On the far right is a simple line drawing of a boy. A dashed line starts from the ball and ends at the boy, passing through four solid circles. The first circle has a large arrow pointing to the left, and the last circle has a large arrow pointing to the right. This layout suggests a path that starts at the boy, goes left through the circles, and ends at the ball.

Actividades para mejorar motricidad fina

Sigue con tu lápiz los círculos para unir al niño con su pelota

The worksheet contains seven rows of a zig-zag path of circles. Each row starts with a ball icon on the left and ends with a boy icon on the right. The path consists of circles connected by small squares, with arrows pointing in the direction of the path. The paths are arranged in a descending staircase pattern from top-left to bottom-right.

Actividades para mejorar motricidad fina

Sigue con tu lápiz los círculos para unir al niño con su pelota

The worksheet contains seven rows of tracing exercises. Each row is designed to connect a ball on the left to a boy on the right. The path for each row is as follows: a solid circle with an arrow pointing left, followed by a dotted line connecting three more solid circles, and finally a solid circle with an arrow pointing right.

Actividades para mejorar motricidad fina

Sigue con tu lápiz los círculos para unir al niño con su pelota

The worksheet contains seven identical rows. Each row starts on the left with a ball icon. To its right is a circle with an arrow pointing left. This is followed by a path of seven circles that curves upwards and then downwards. The path ends with a circle on the right that has an arrow pointing right towards a boy icon.

Actividades para mejorar motricidad fina

Sigue con tu lápiz los círculos para unir al niño con su pelota

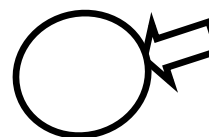
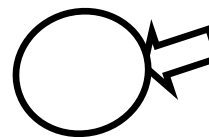
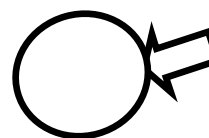
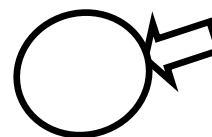
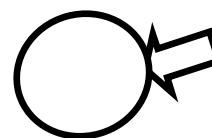
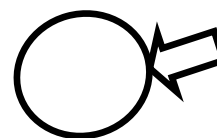
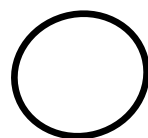
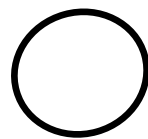
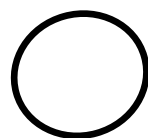
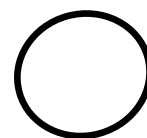
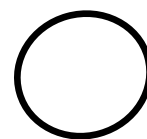
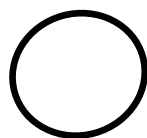
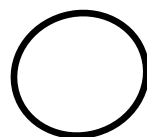
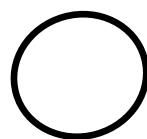
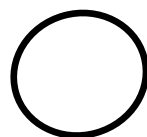
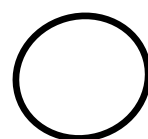
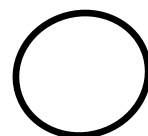
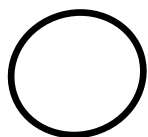
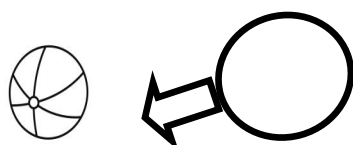
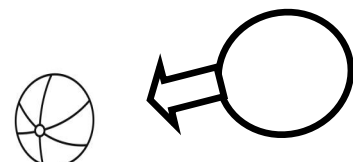
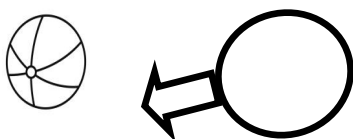
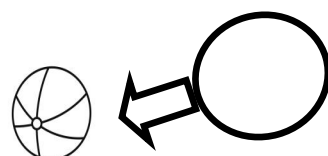
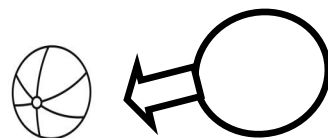
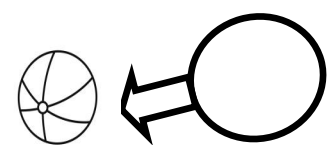

Actividades para mejorar motricidad fina

Sigue con tu lápiz los cuadrados para unir a la niña con su casa

The worksheet contains six rows of tracing exercises. Each row starts on the left with a simple line drawing of a house with a chimney and two windows. From the house, a dashed line leads to a square, which is connected to another square, and so on, forming a chain of five squares per row. The dashed line ends at a girl icon on the right, who is also connected to the final square by a dashed line. A solid arrow at the end of the dashed line points from the girl towards the house, indicating the direction of the tracing activity.

Actividades para mejorar motricidad fina

Sigue con tu lápiz los cuadrados para unir a la niña con su casa

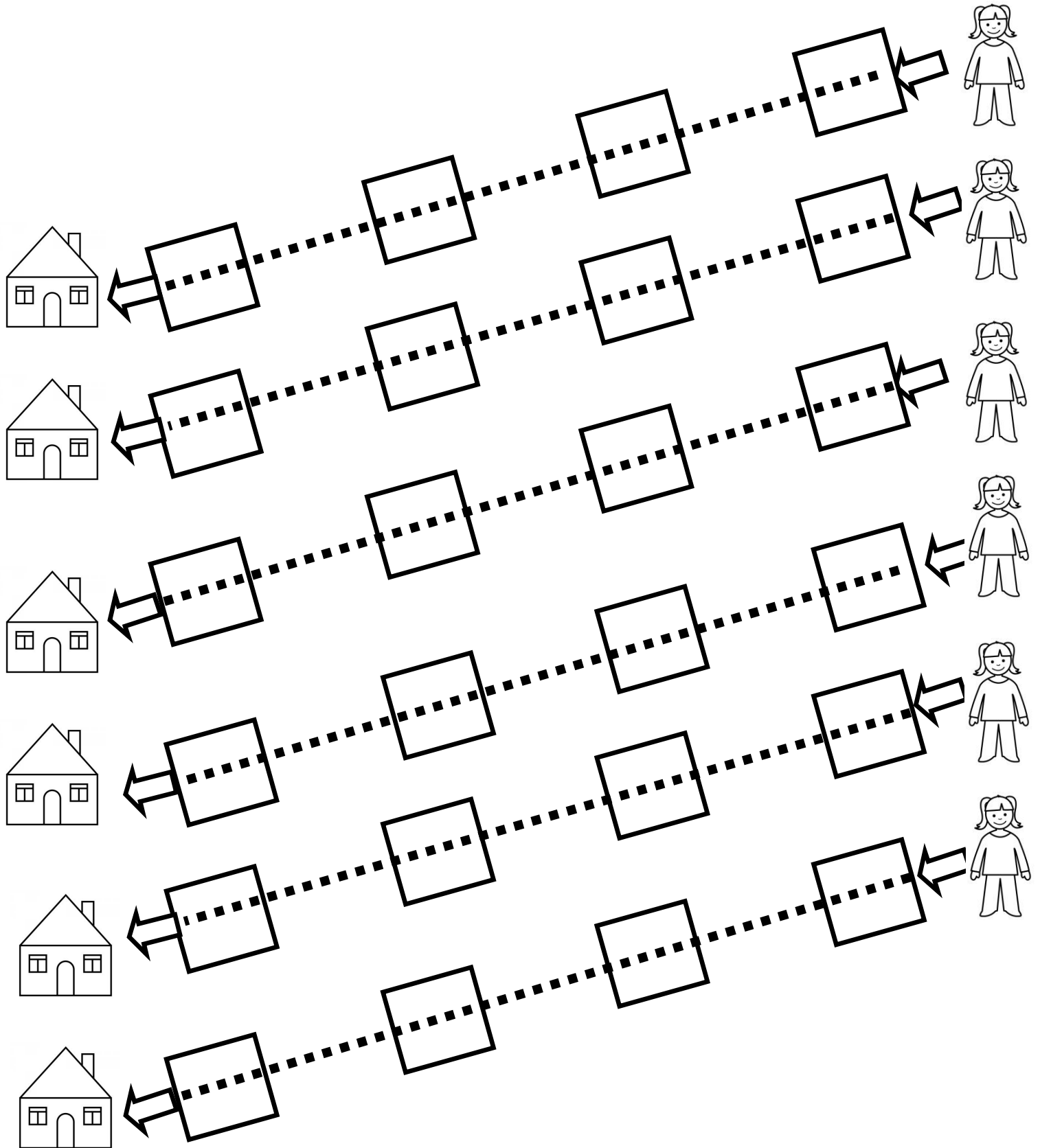

Actividades para mejorar motricidad fina

Sigue con tu lápiz los cuadrados para unir a la niña con su casa

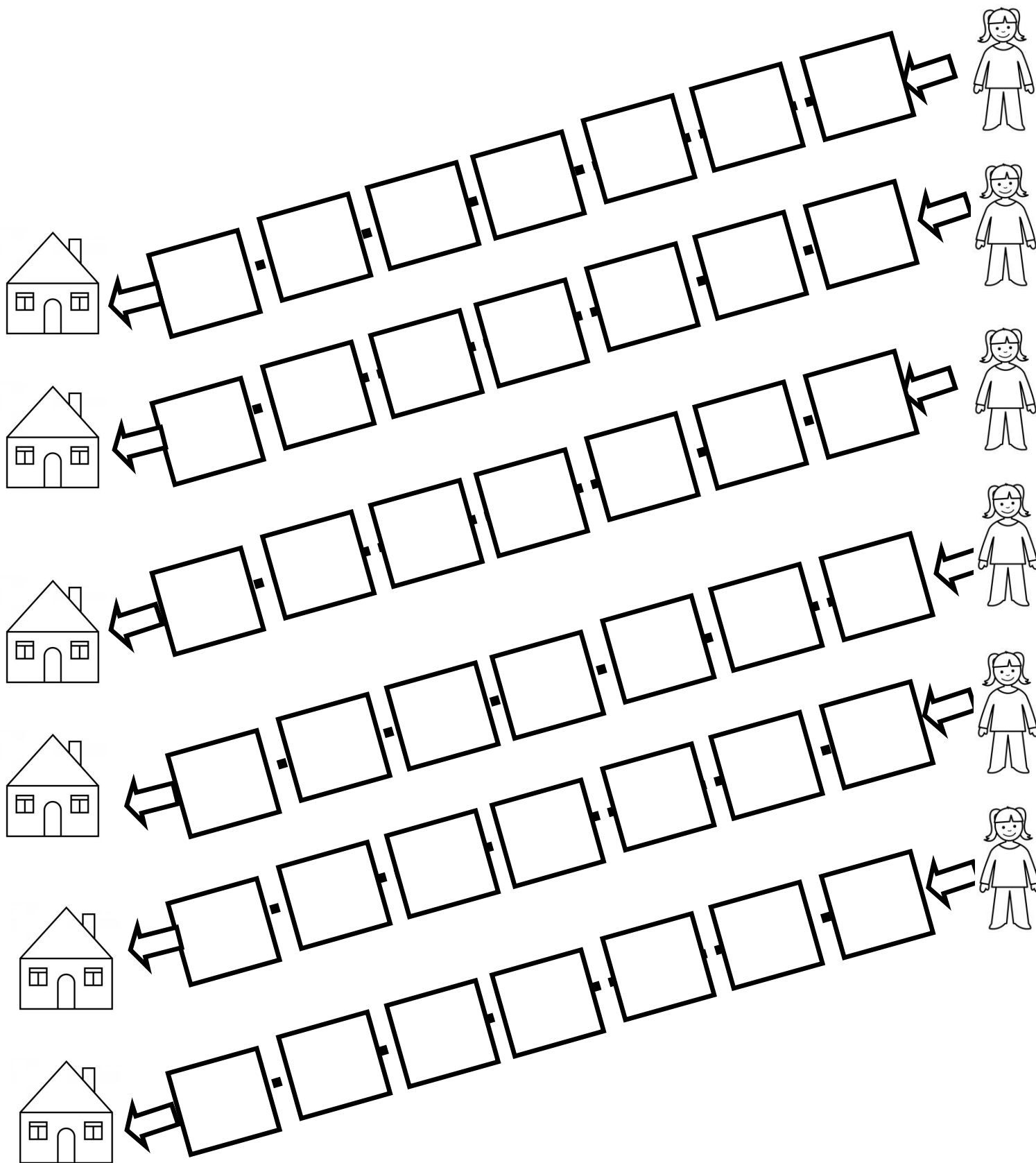

Actividades para mejorar motricidad fina

Sigue con tu lápiz los cuadrados para unir a la niña con su casa

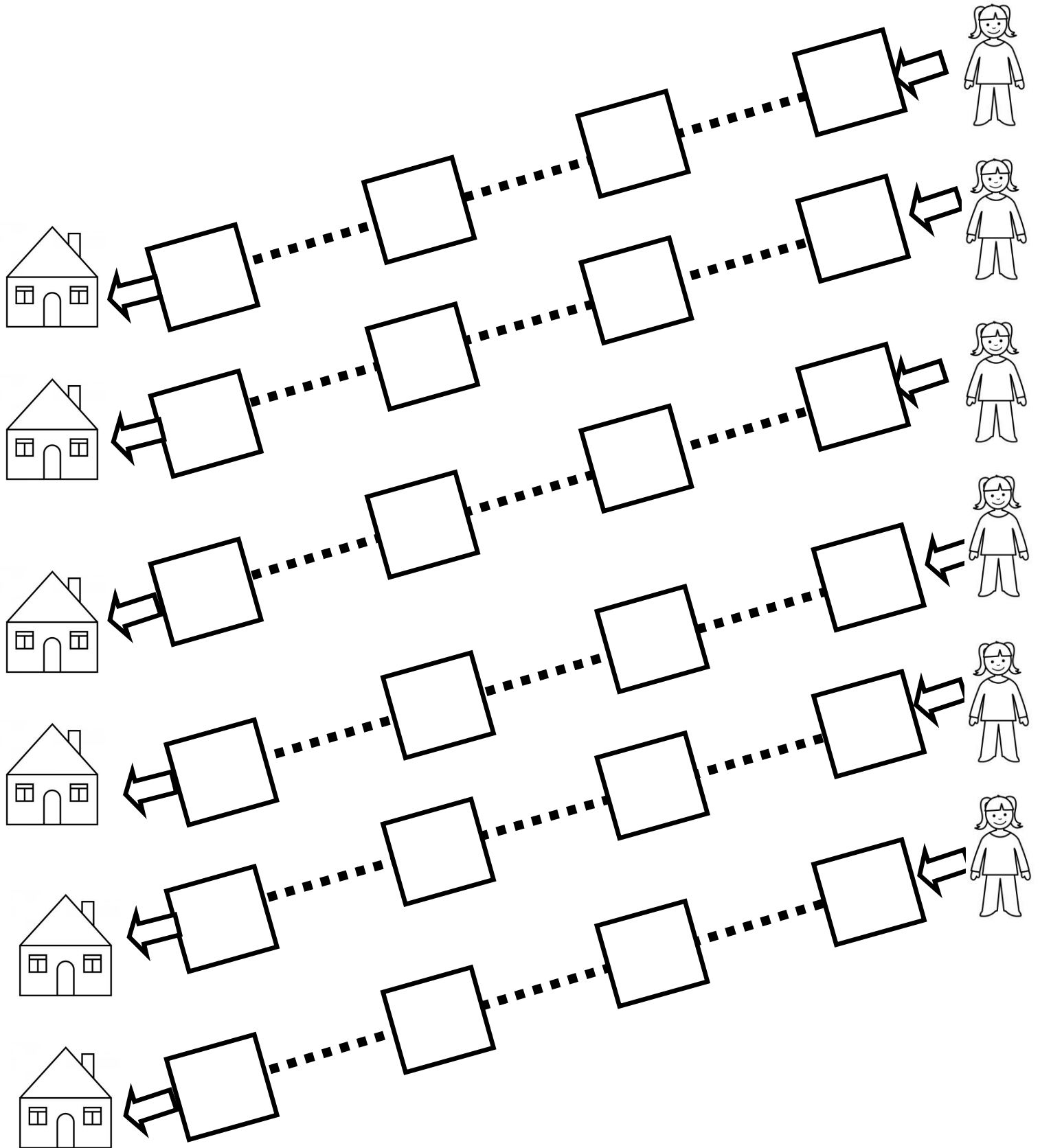

Actividades para mejorar motricidad fina

Sigue con tu lápiz los cuadrados para unir a la niña con su casa

The worksheet contains six identical rows of a dot-marker maze. Each row consists of a sequence of squares connected by arrows pointing to the left. The squares are arranged in a zig-zag pattern, starting from the girl icon on the right and ending at the house icon on the left. The goal is to trace the path from the girl to her house.

Actividades para mejorar motricidad fina

Sigue con tu lápiz los cuadrados para unir a la niña con su casa

The worksheet consists of 18 squares arranged in 6 rows and 3 columns. Each square is tilted at an angle. On the left side of each row, there is a house icon. On the right side of each row, there is a girl icon. An arrow points from the girl icon towards the house icon, passing through the square. The squares are intended to be traced with a pencil to connect the girl to her house.

Actividades para mejorar motricidad fina

Sigue con tu lápiz las estrellitas para ir desde el sol a la tierra

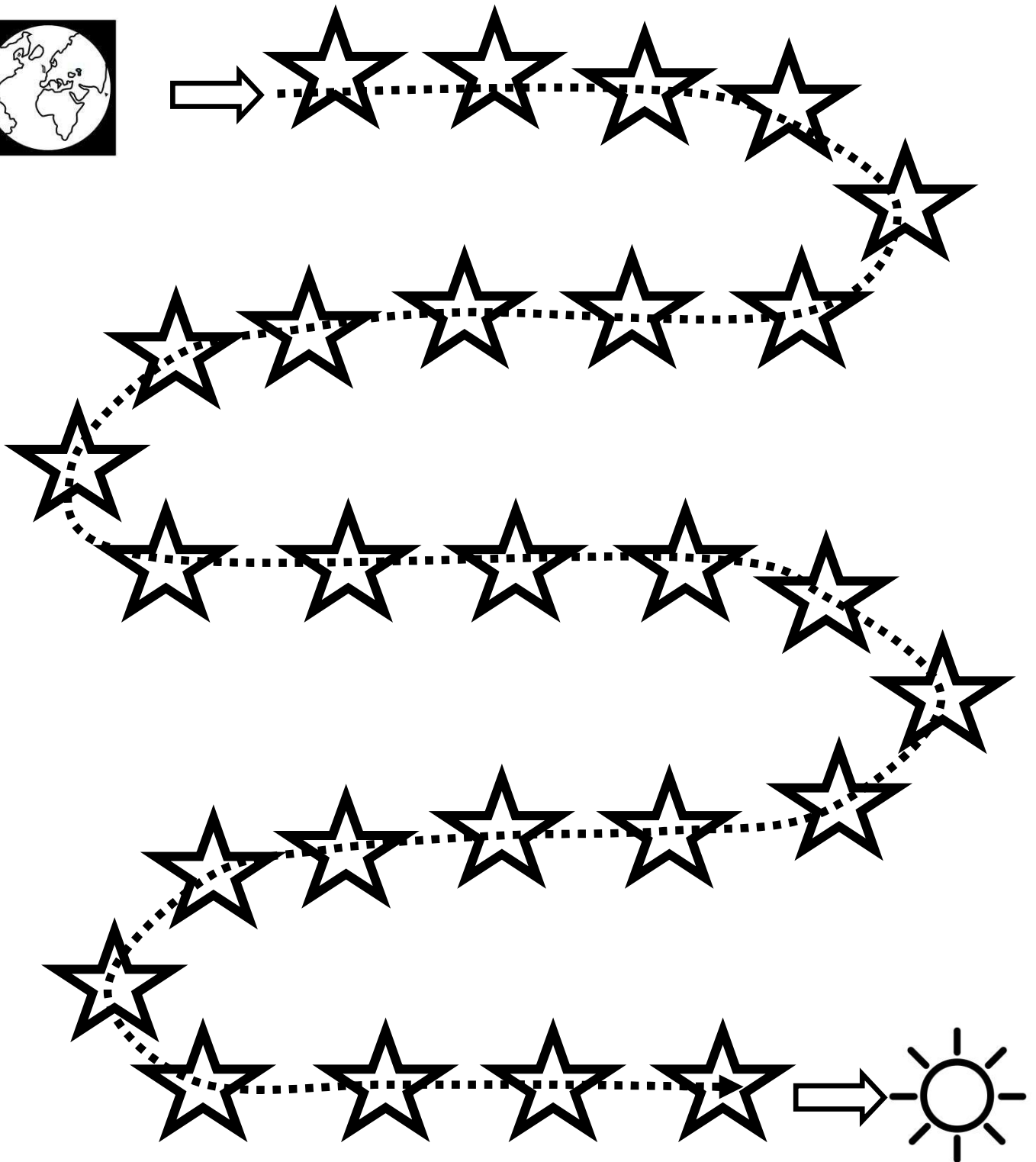

Actividades para mejorar motricidad fina

Sigue con tu lápiz las estrellitas para ir desde el sol a la tierra

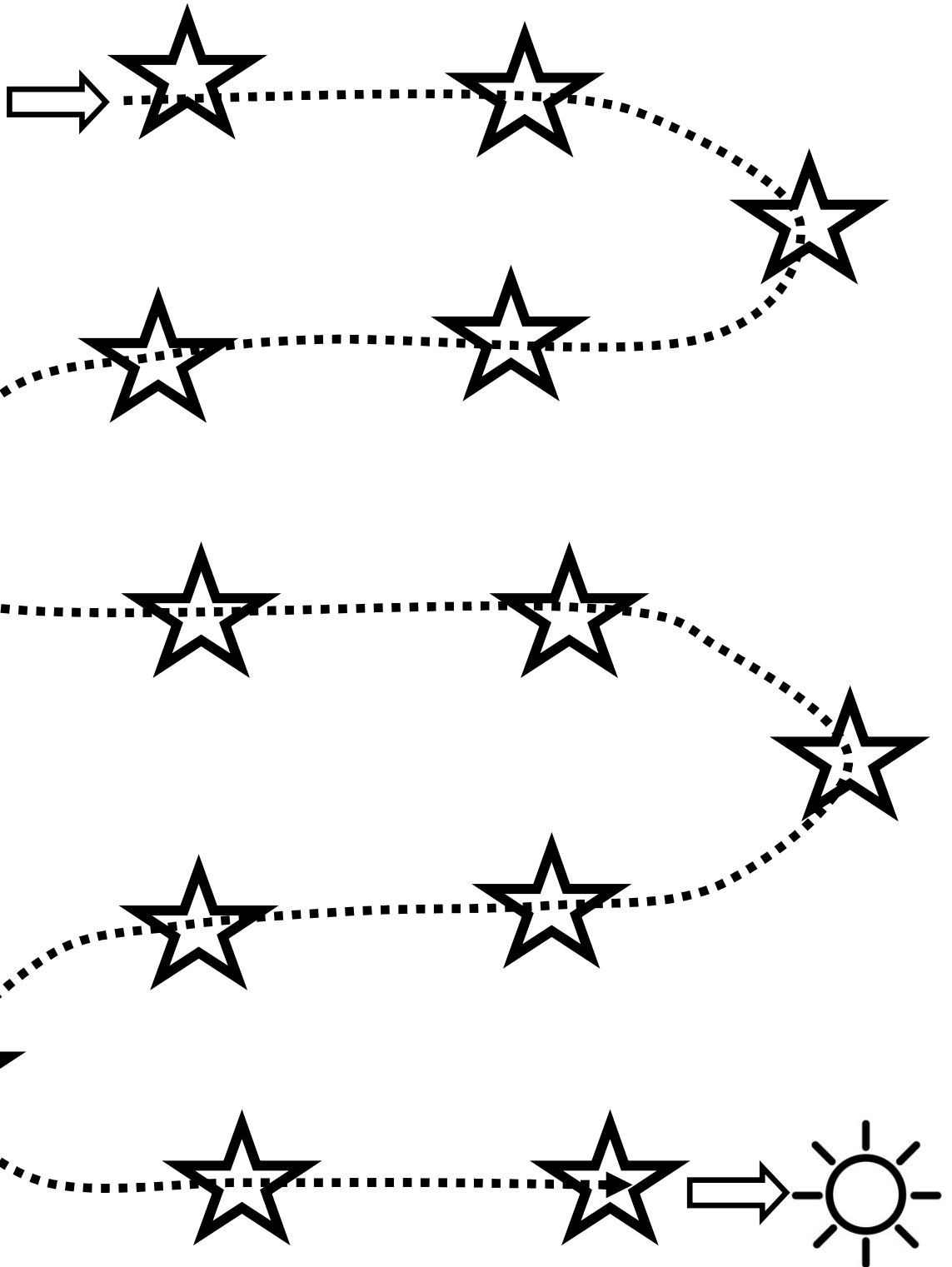

Actividades para mejorar motricidad fina

Sigue con tu lápiz las estrellitas para ir desde el sol a la tierra

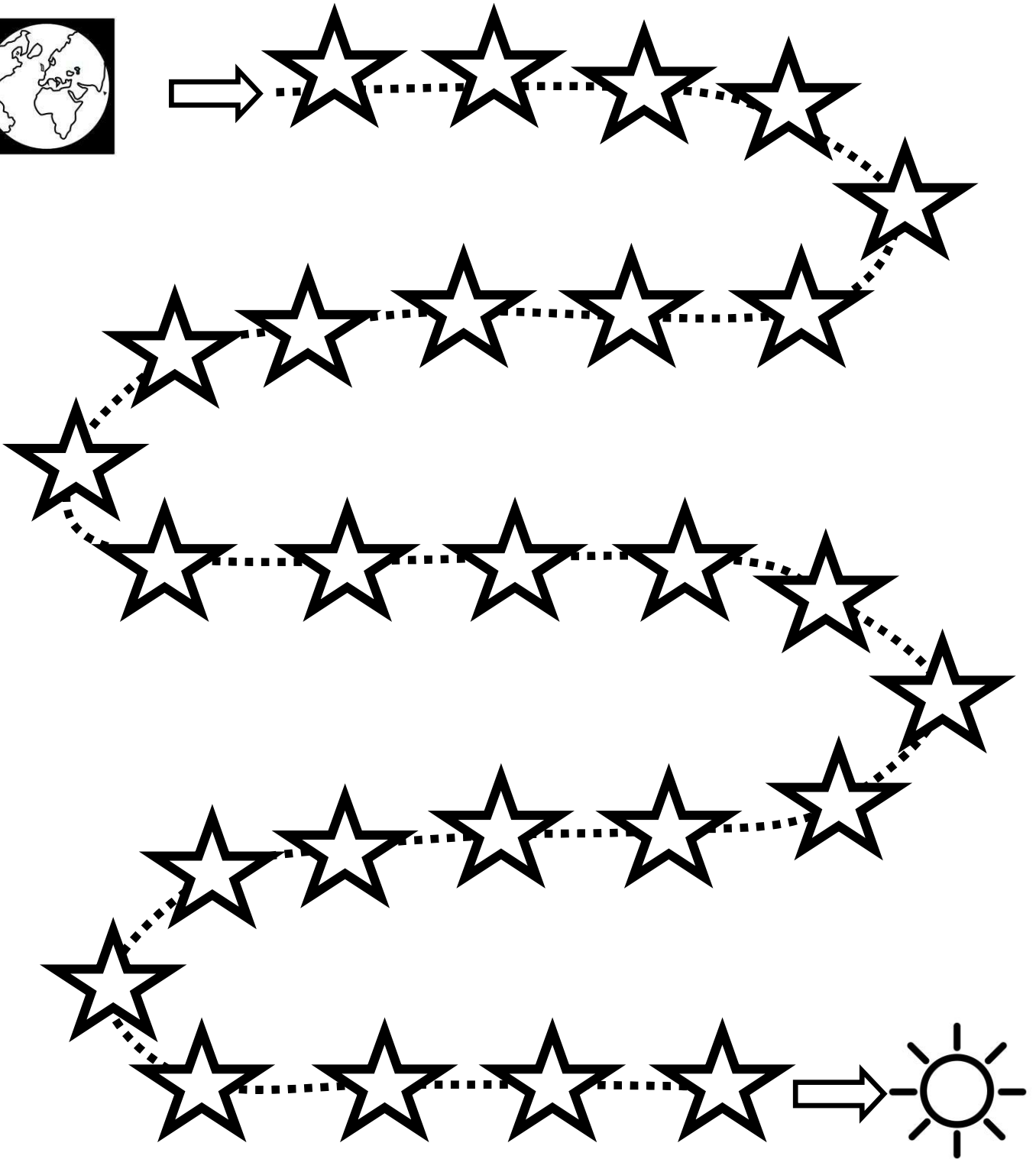

Actividades para mejorar motricidad fina

Sigue con tu lápiz las estrellitas para ir desde el sol a la tierra

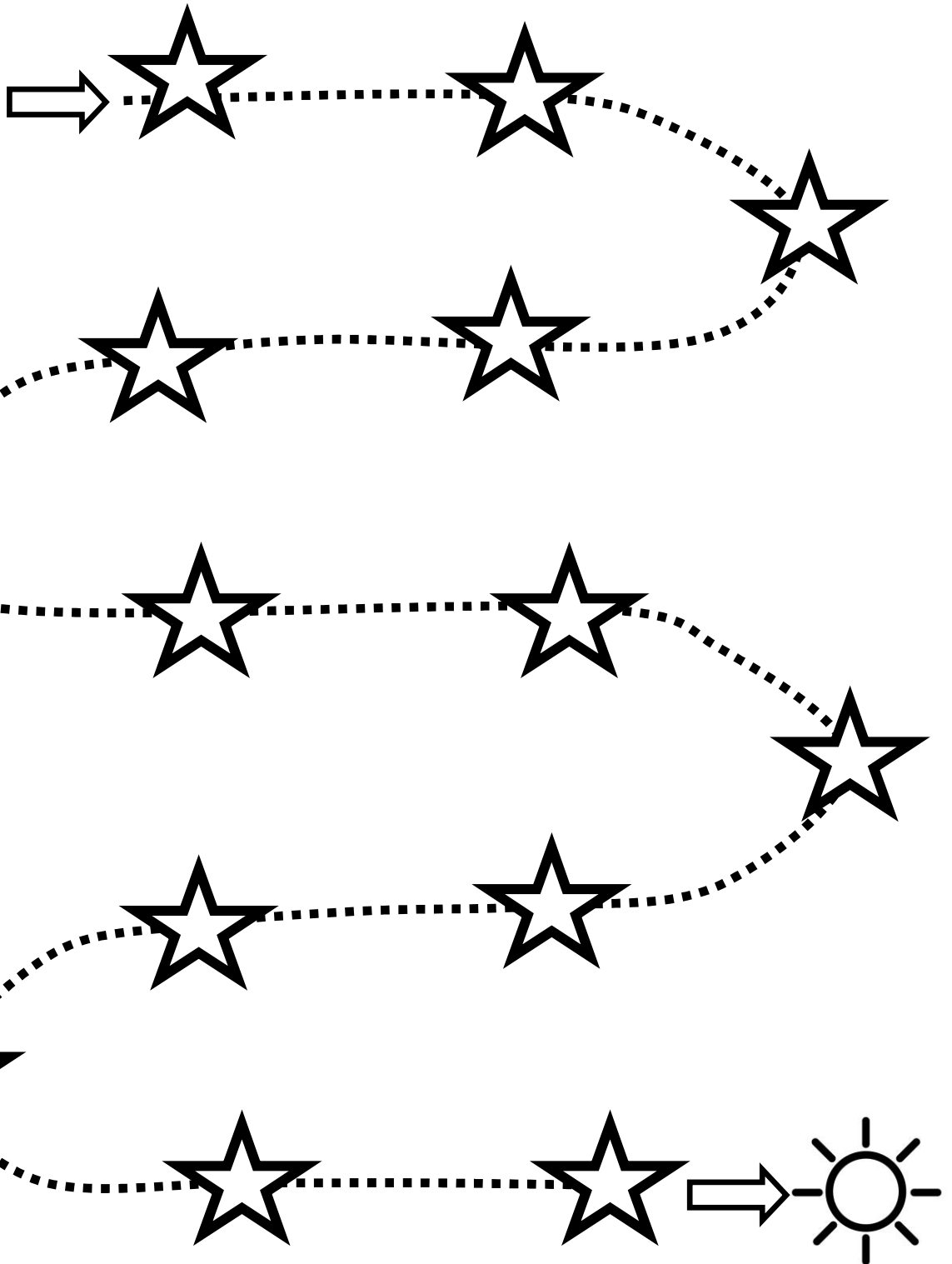

Actividades para mejorar motricidad fina

Sigue con tu lápiz las estrellitas para ir desde el sol a la tierra



Actividades para mejorar motricidad fina

Sigue con tu lápiz las estrellitas para ir desde el sol a la tierra

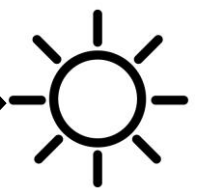
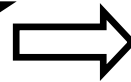
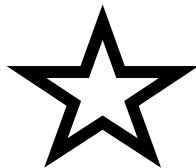
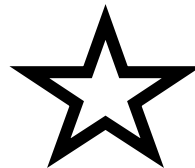
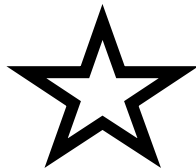
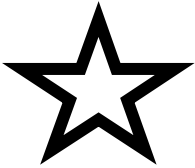

Actividades para mejorar motricidad fina

Sigue con tu lápiz los corazones para unir a la mama y a su bebe

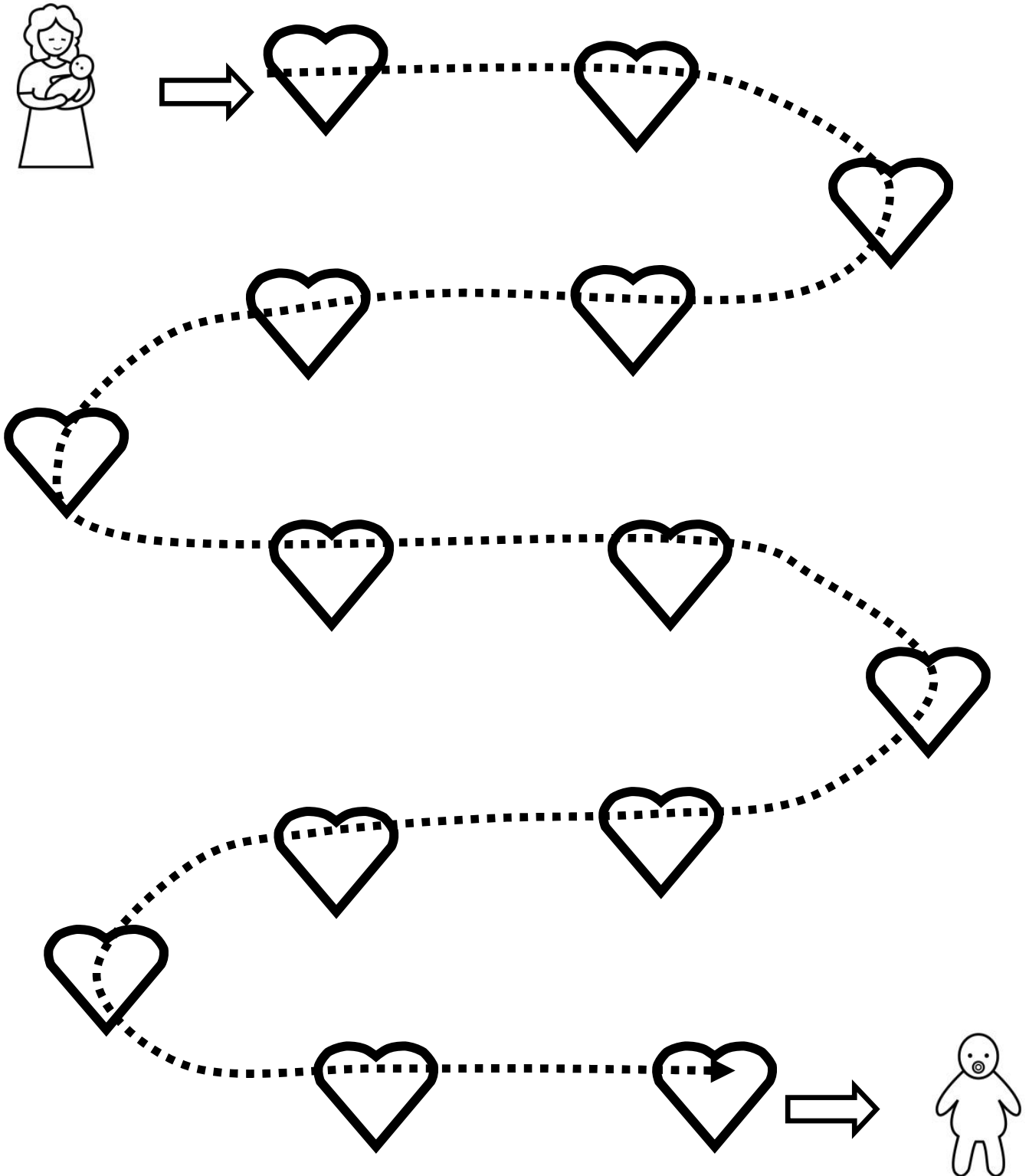

Actividades para mejorar motricidad fina

Sigue con tu lápiz los corazones para unir a la mama y a su bebe

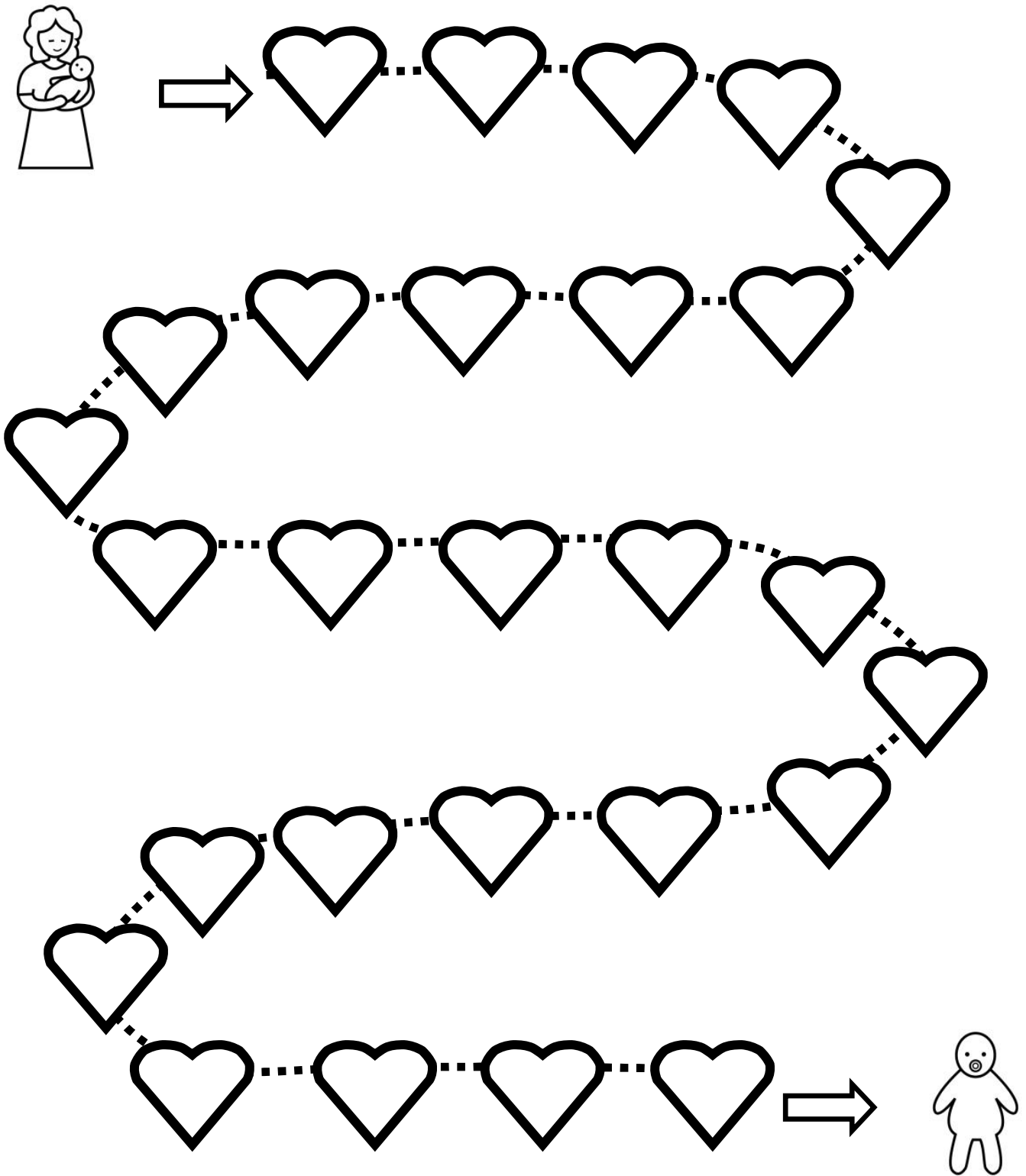

Actividades para mejorar motricidad fina

Sigue con tu lápiz los corazones para unir a la mama y a su bebe

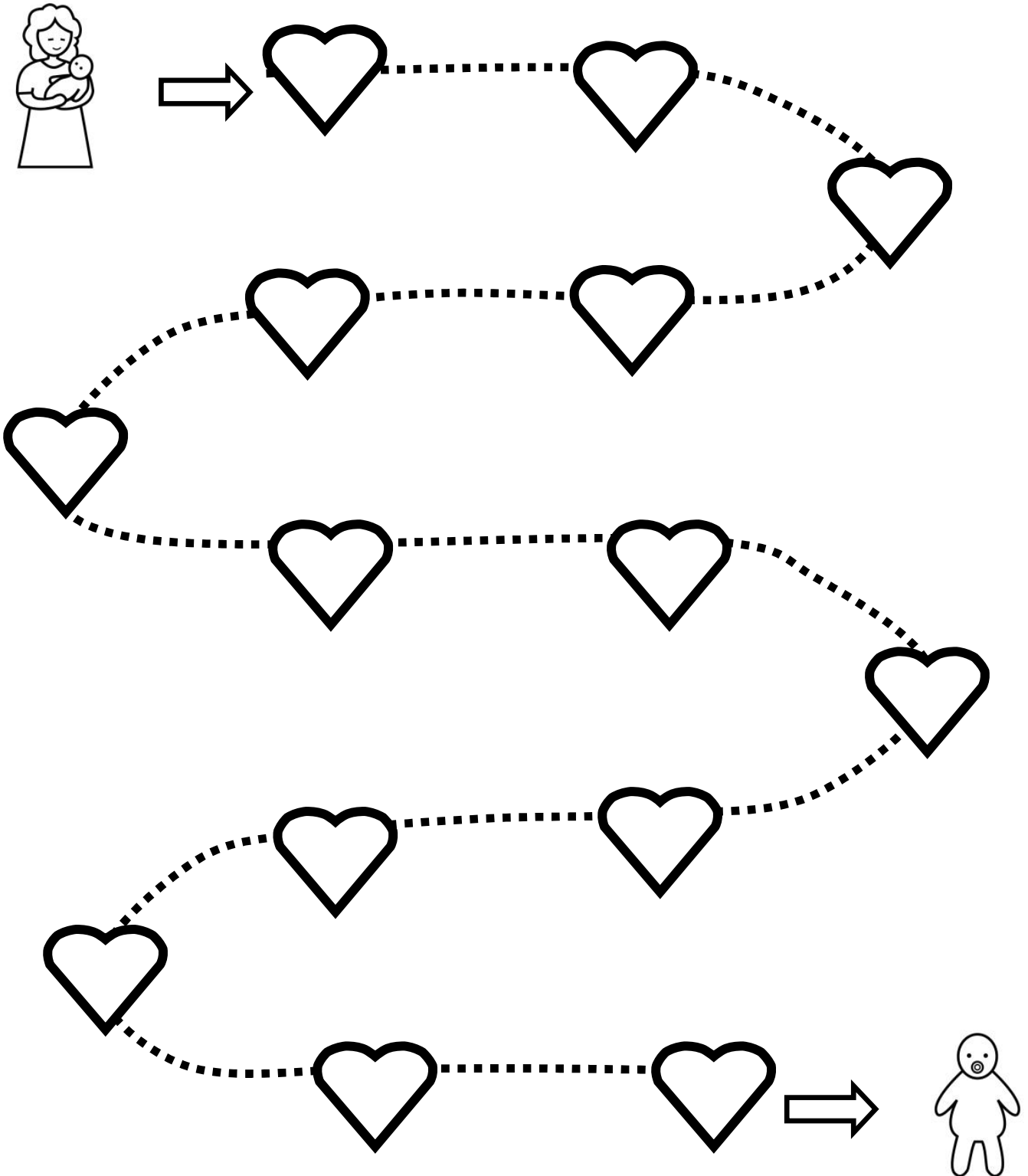

Actividades para mejorar motricidad fina

Sigue con tu lápiz los corazones para unir a la mama y a su bebe

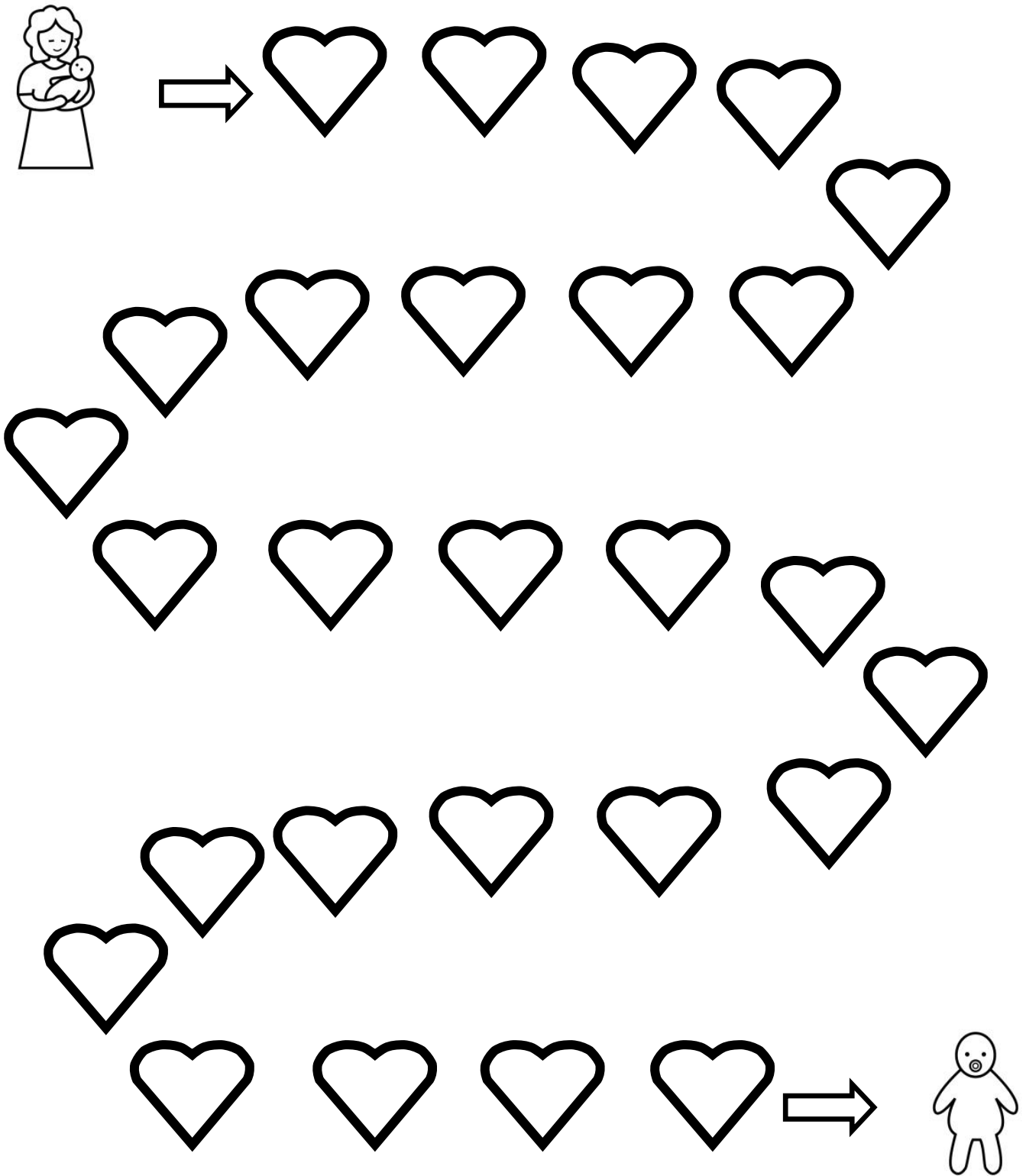

Actividades para mejorar motricidad fina

Sigue con tu lápiz los corazones para unir a la mama y a su bebe

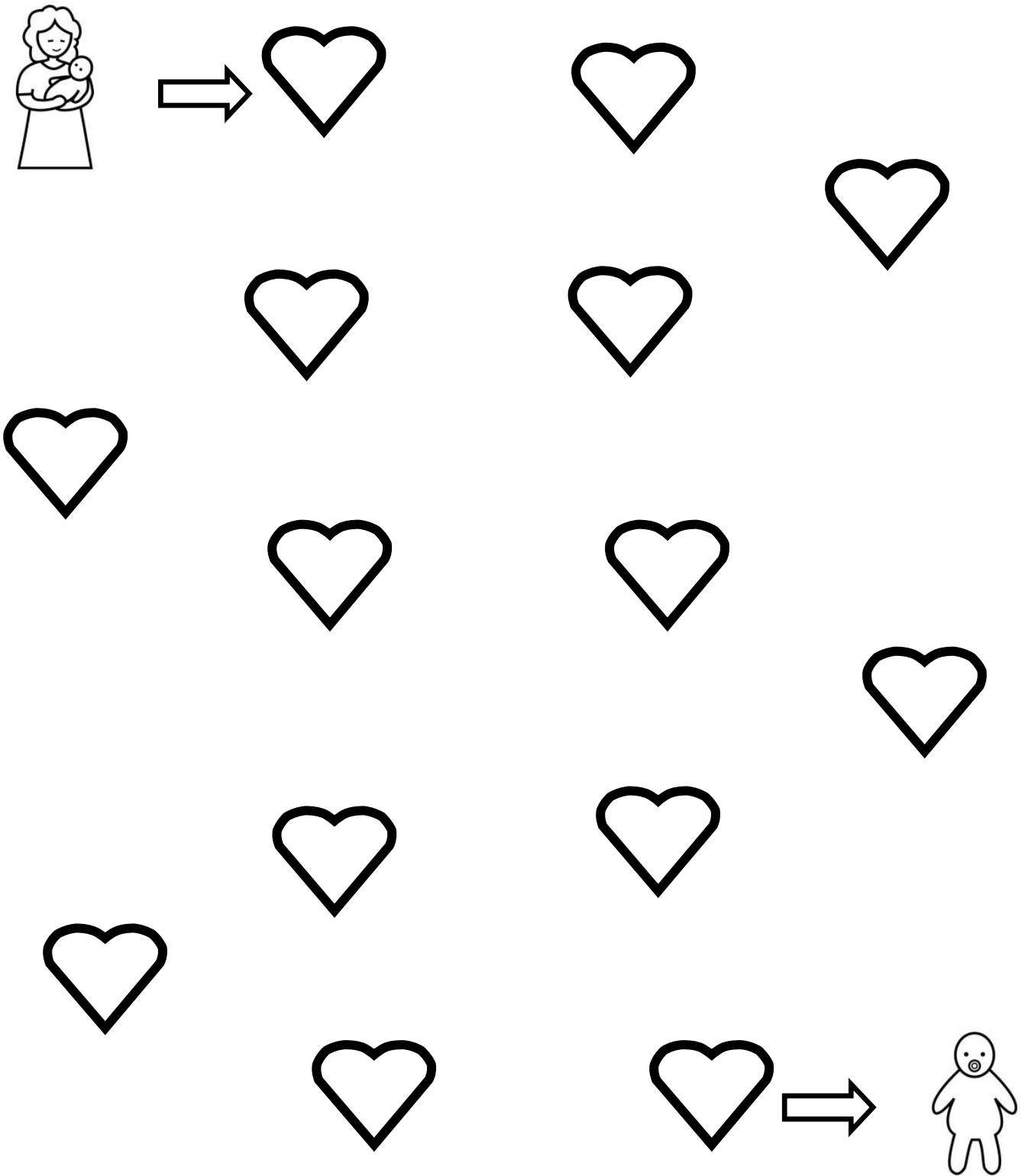

Actividades para mejorar motricidad fina

Sigue las caras para unir al niño y a la niña

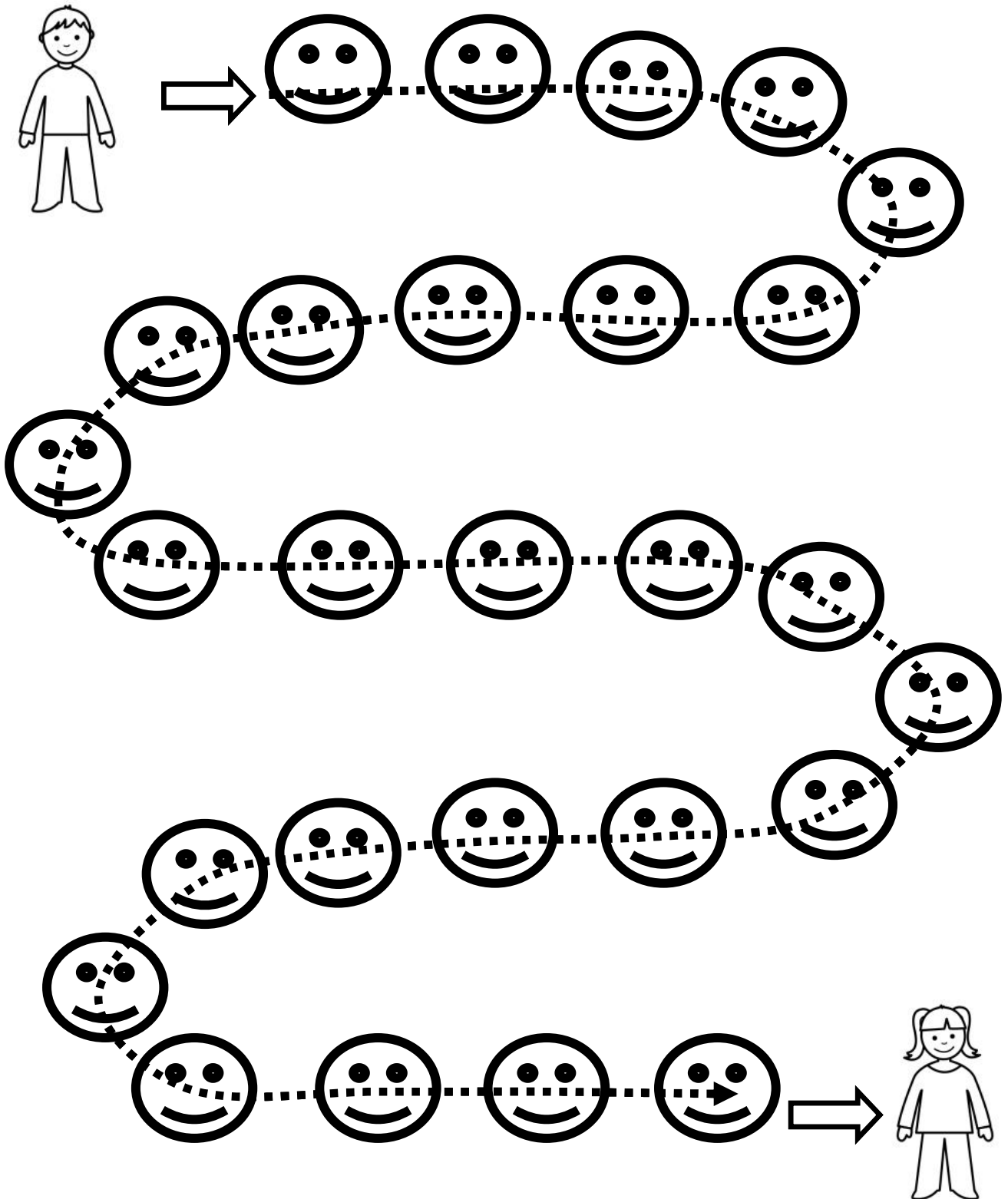

Actividades para mejorar motricidad fina

Sigue las caras para unir al niño y a la niña

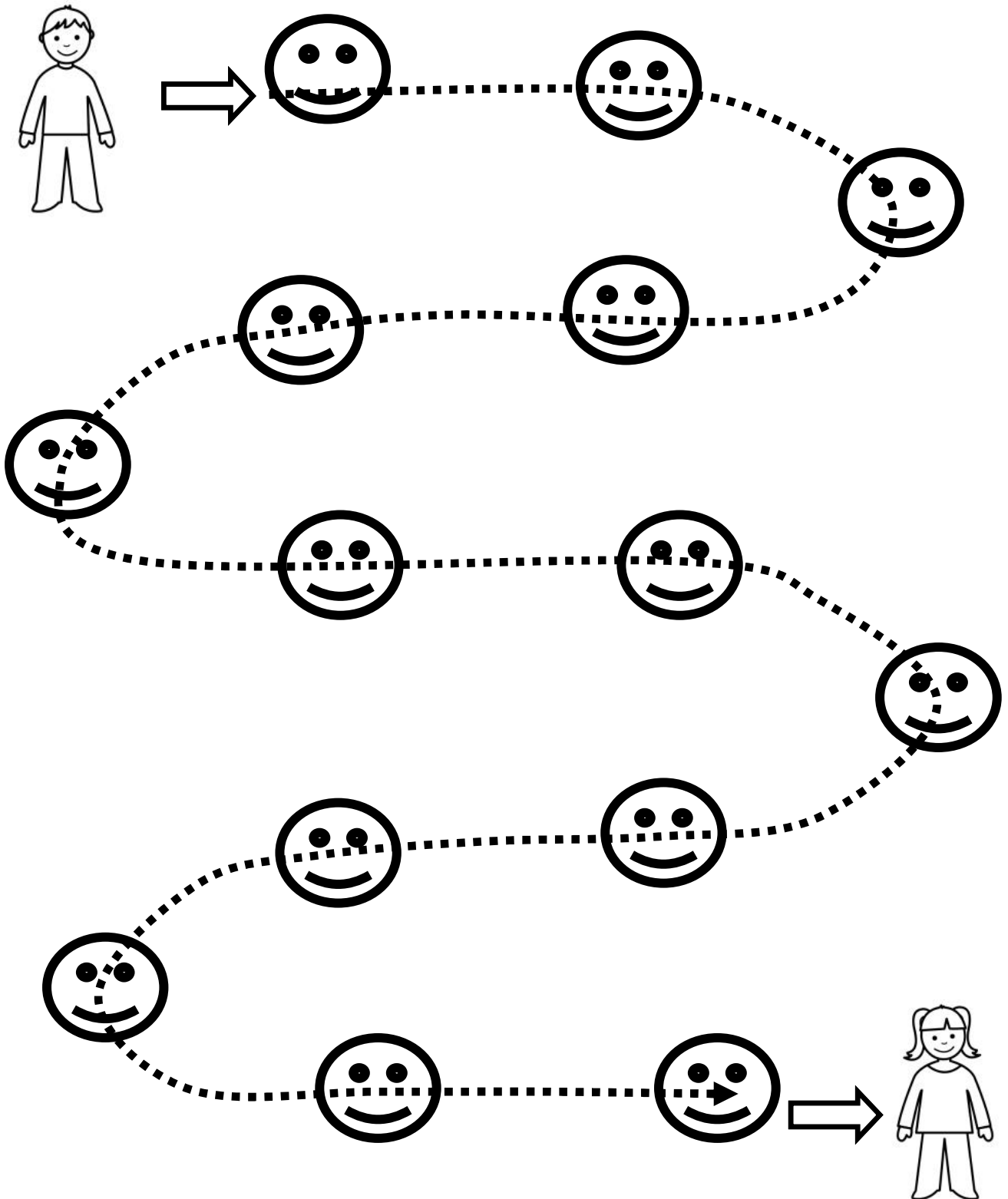

Actividades para mejorar motricidad fina

Sigue las caras para unir al niño y a la niña

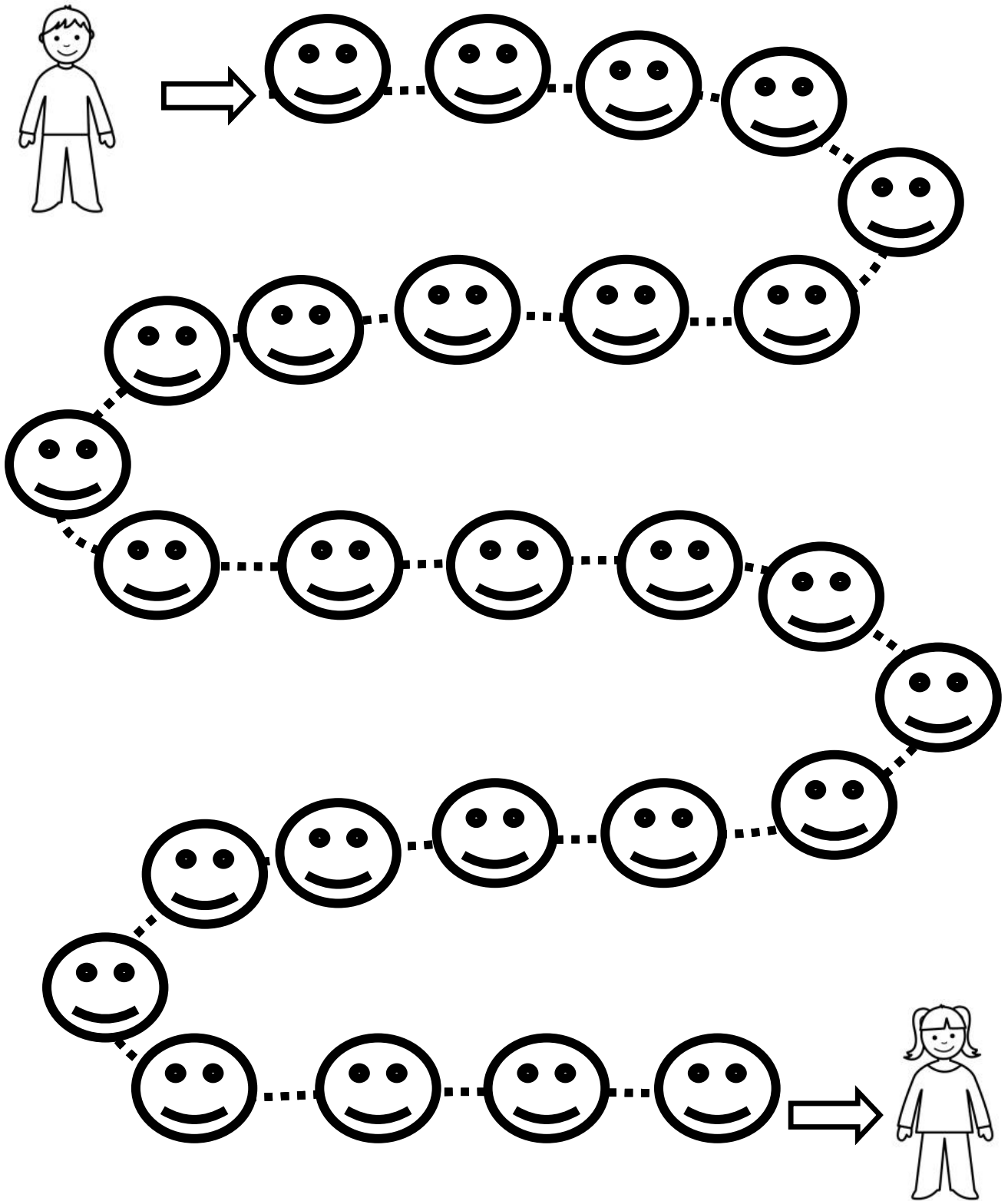

Actividades para mejorar motricidad fina

Sigue las caras para unir al niño y a la niña

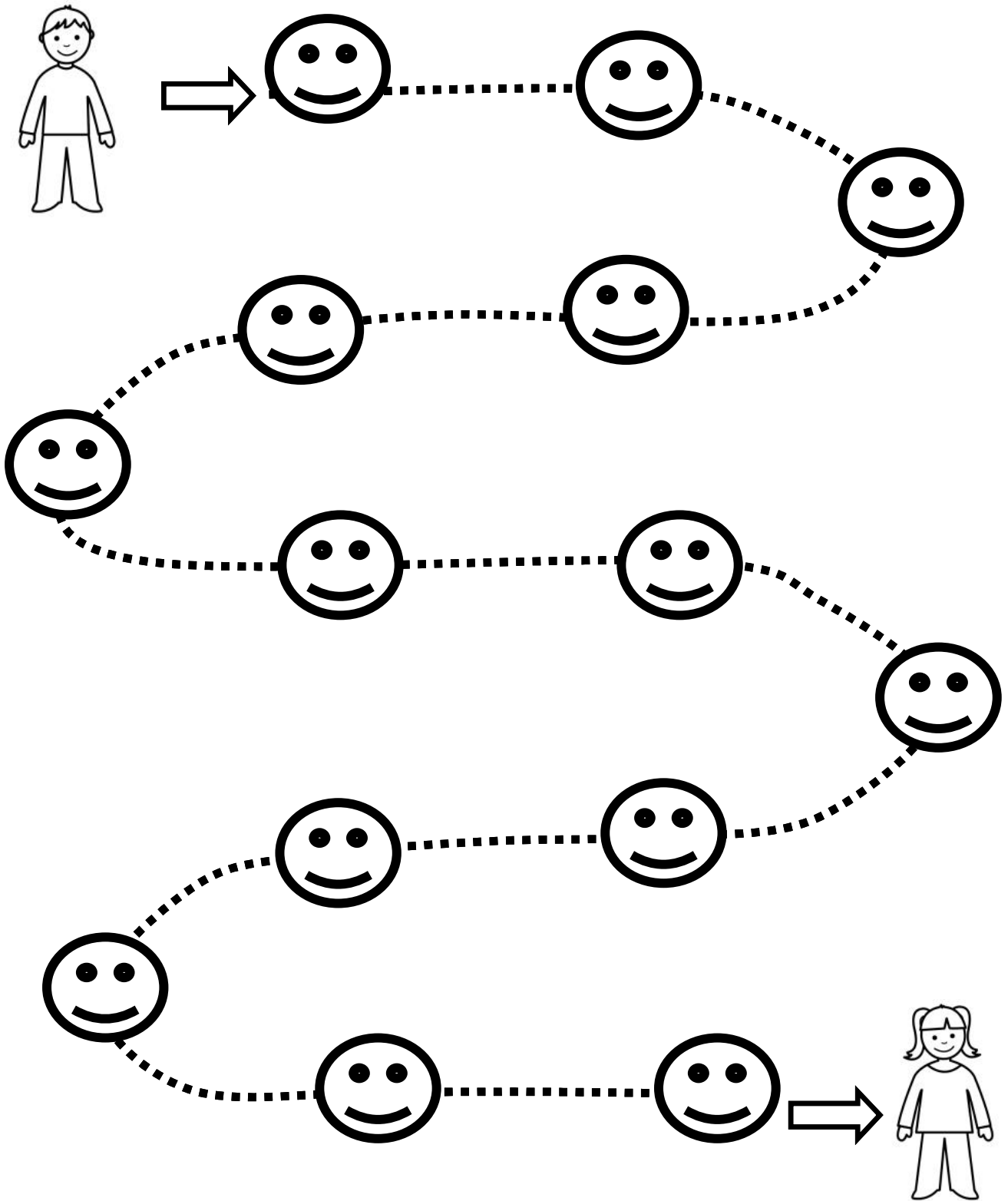

Actividades para mejorar motricidad fina

Sigue las caras para unir al niño y a la niña

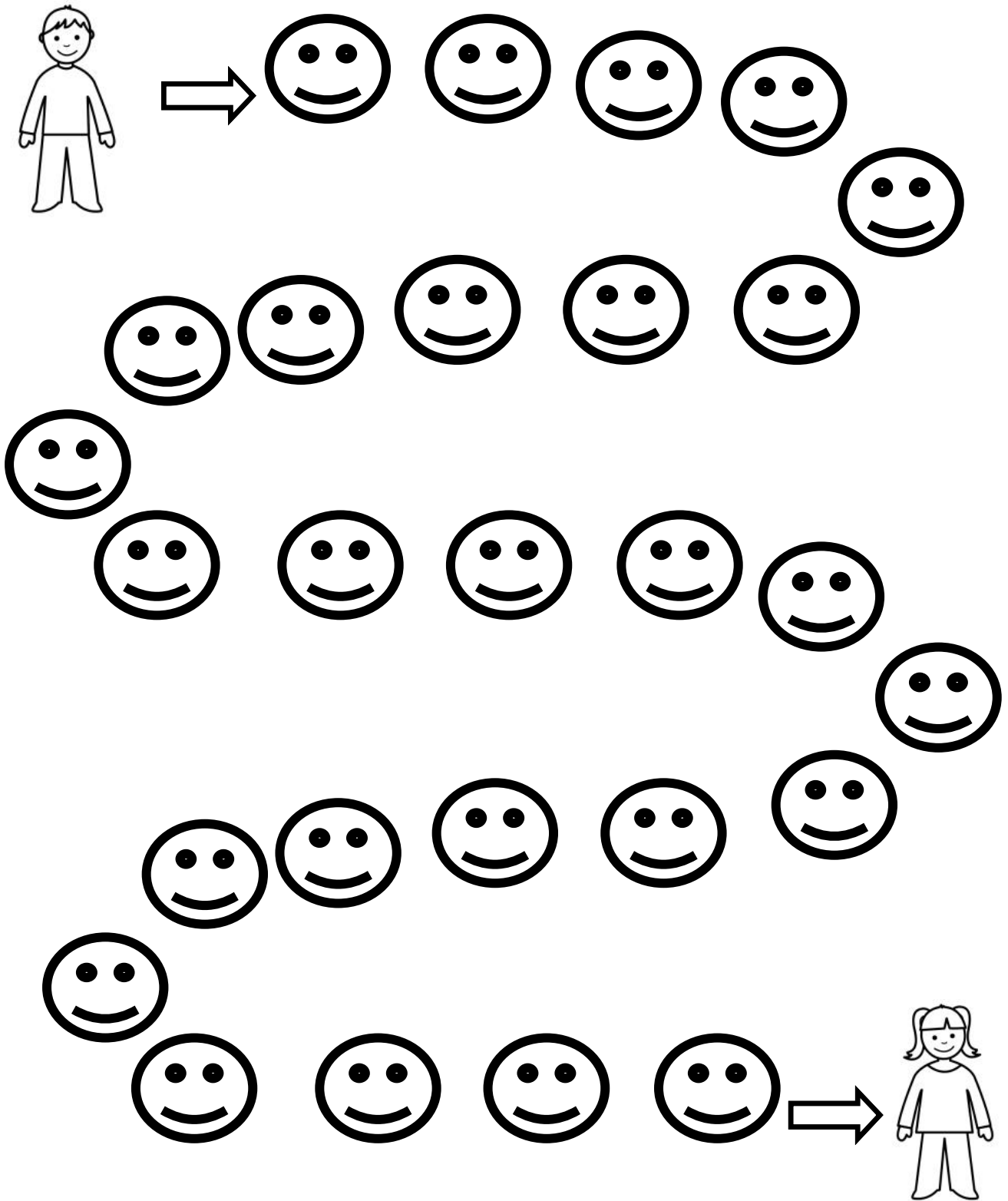

Actividades para mejorar motricidad fina

Sigue las caras para unir al niño y a la niña

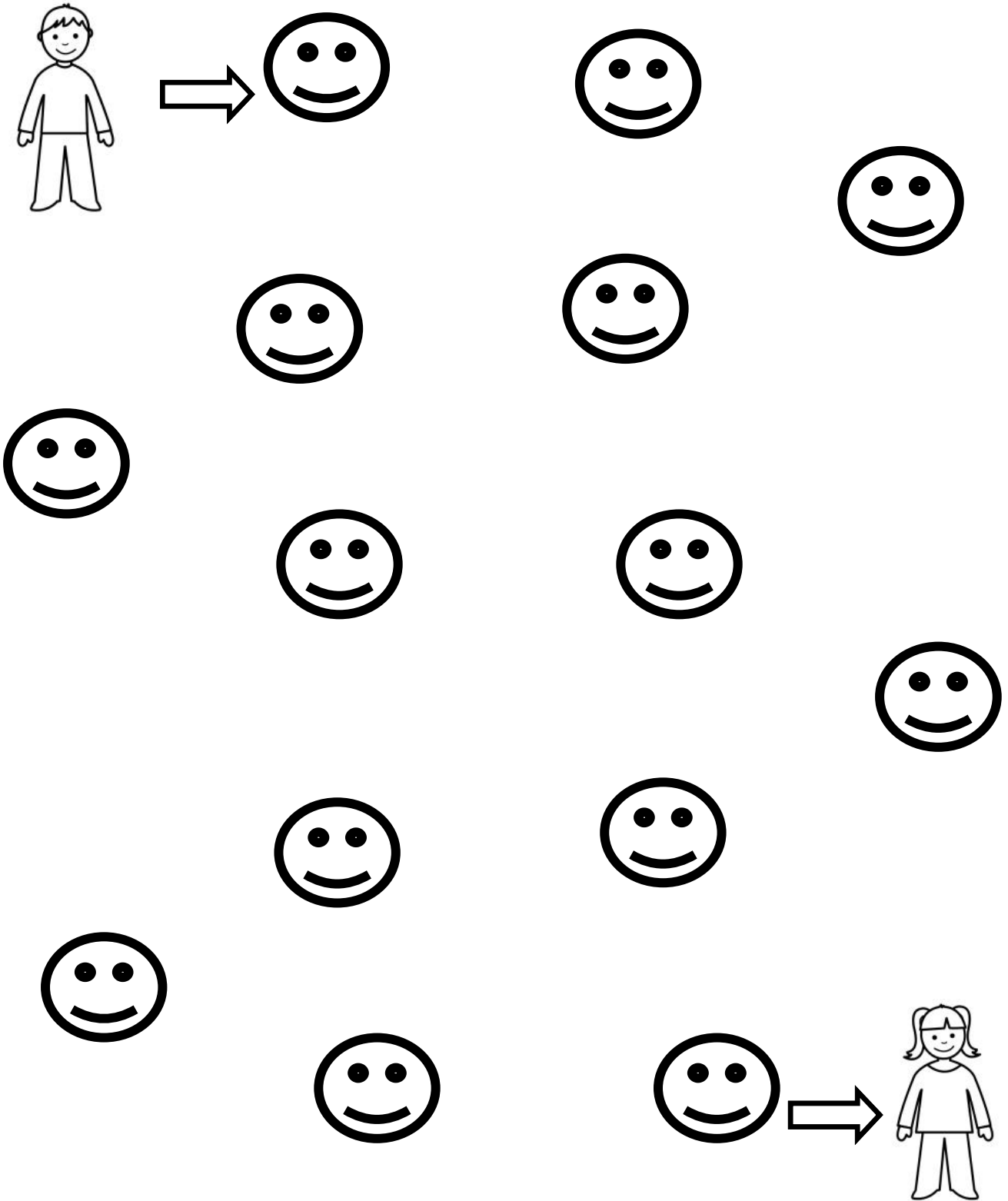

Actividades para mejorar motricidad fina

Sigue los círculos para unir al niño con la pelota

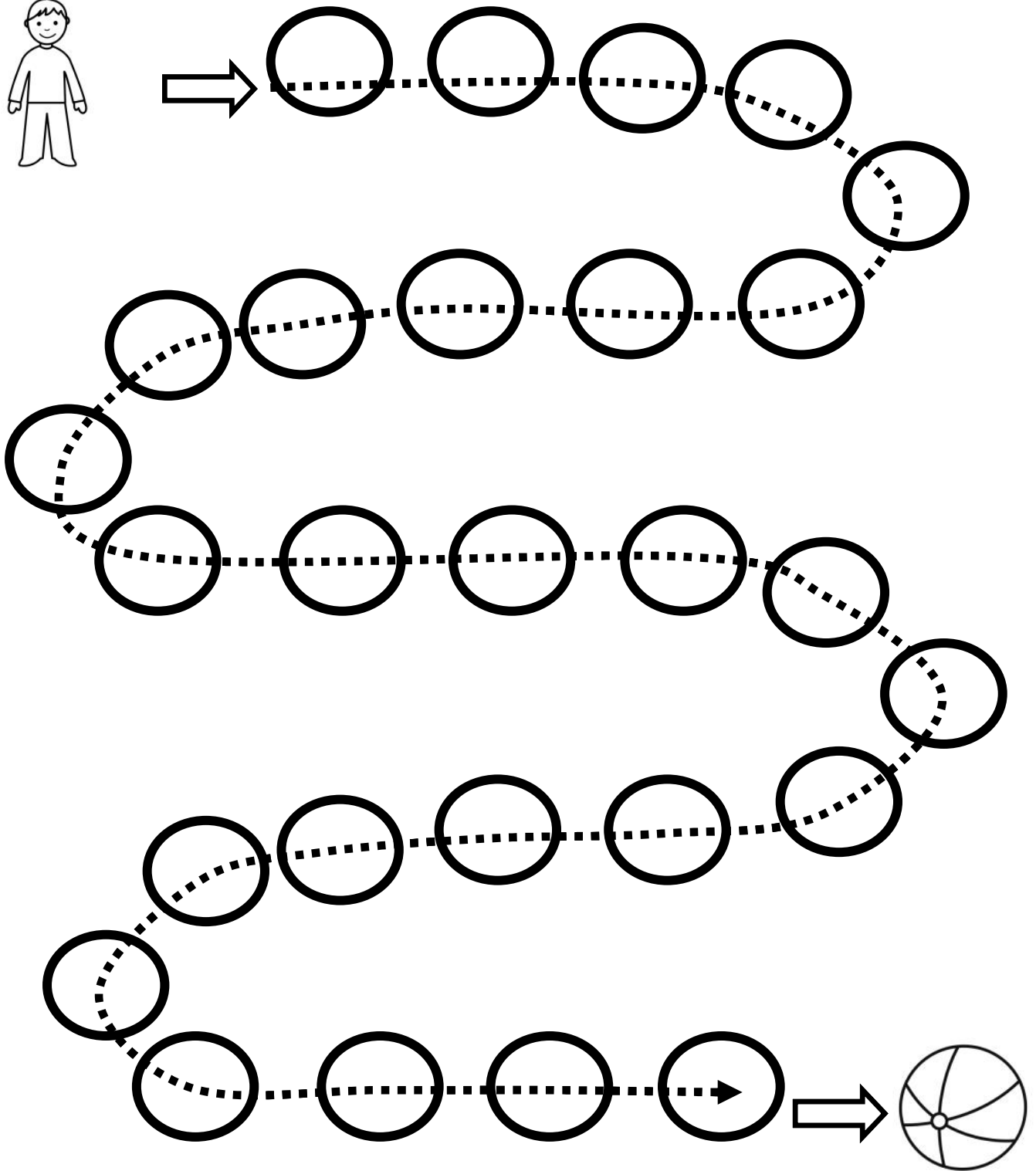
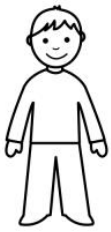

Actividades para mejorar motricidad fina

Sigue los círculos para unir al niño con la pelota

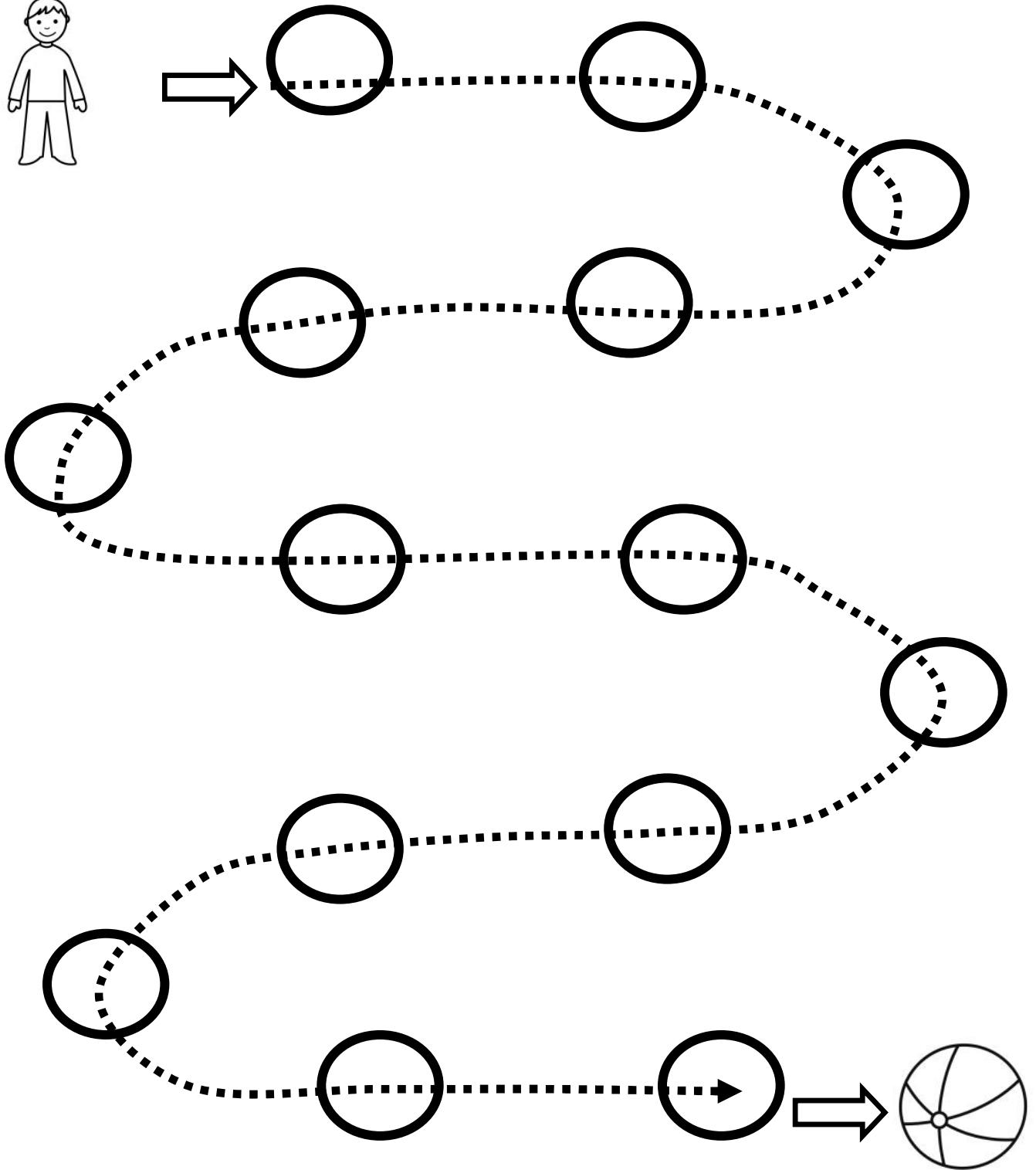
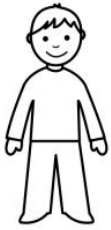

Actividades para mejorar motricidad fina

Sigue los círculos para unir al niño con la pelota

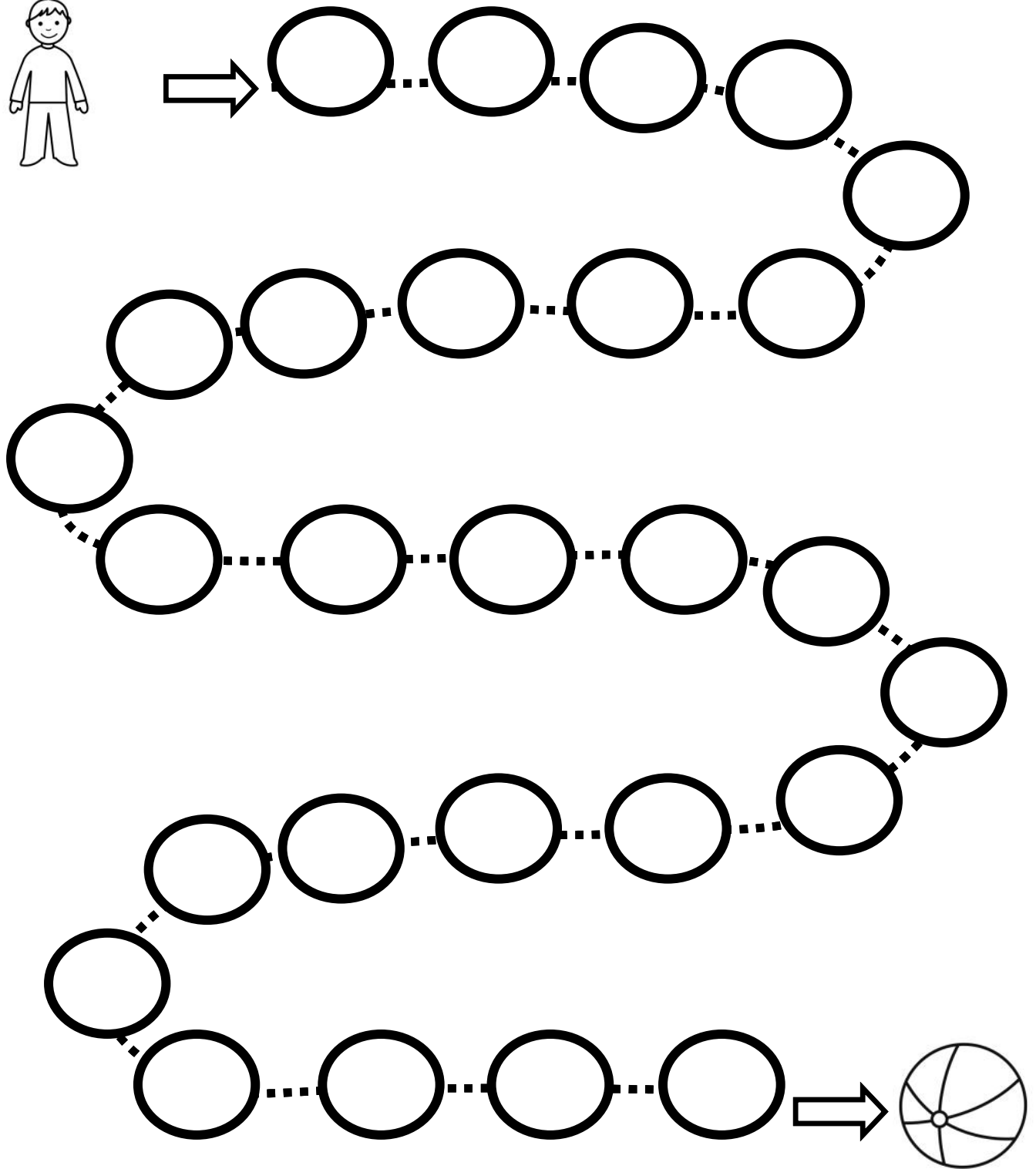
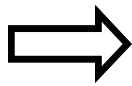
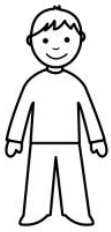

Actividades para mejorar motricidad fina

Sigue los círculos para unir al niño con la pelota

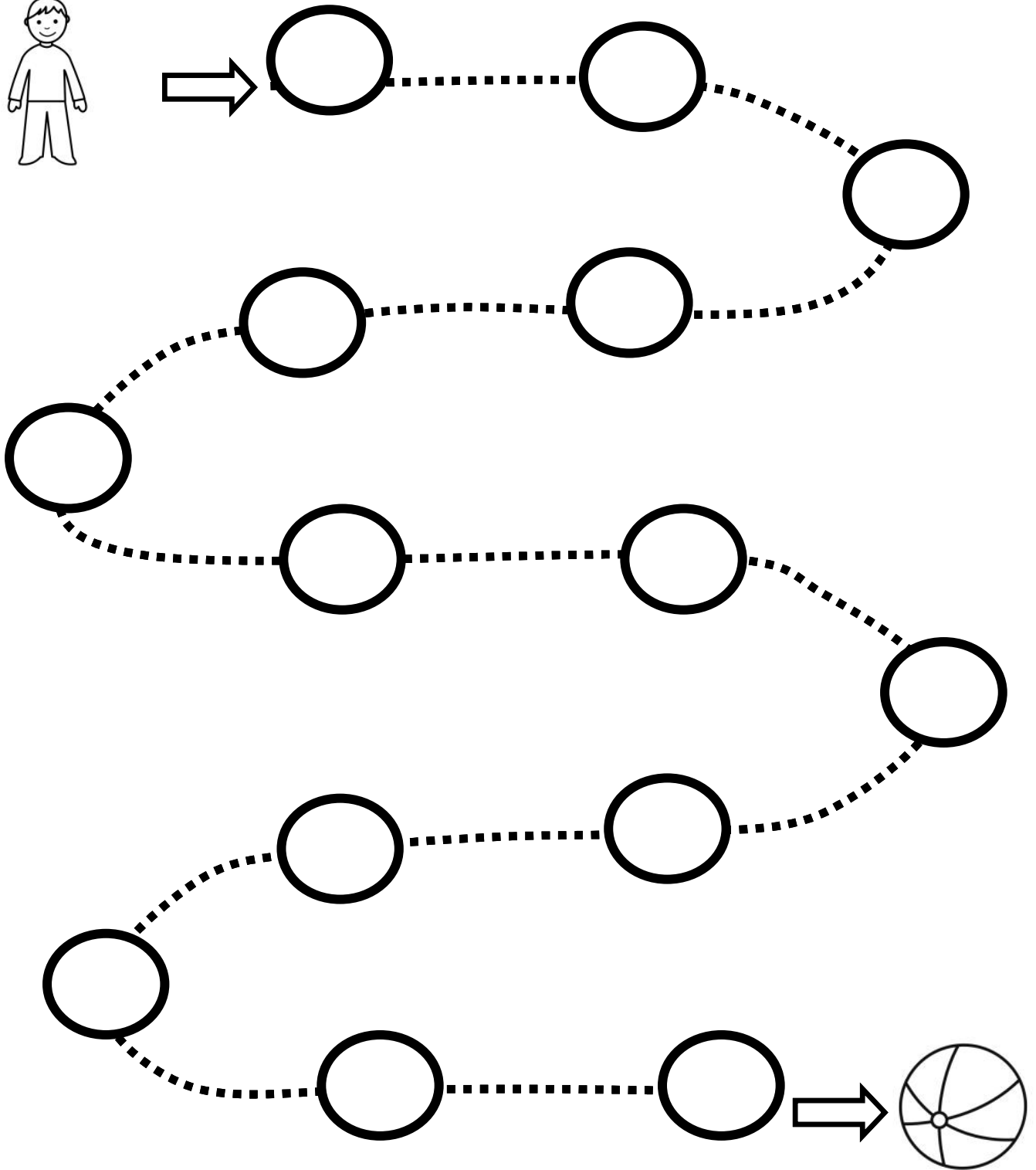
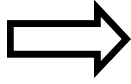
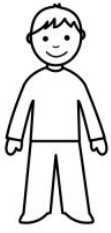

Actividades para mejorar motricidad fina

Sigue los círculos para unir al niño con la pelota

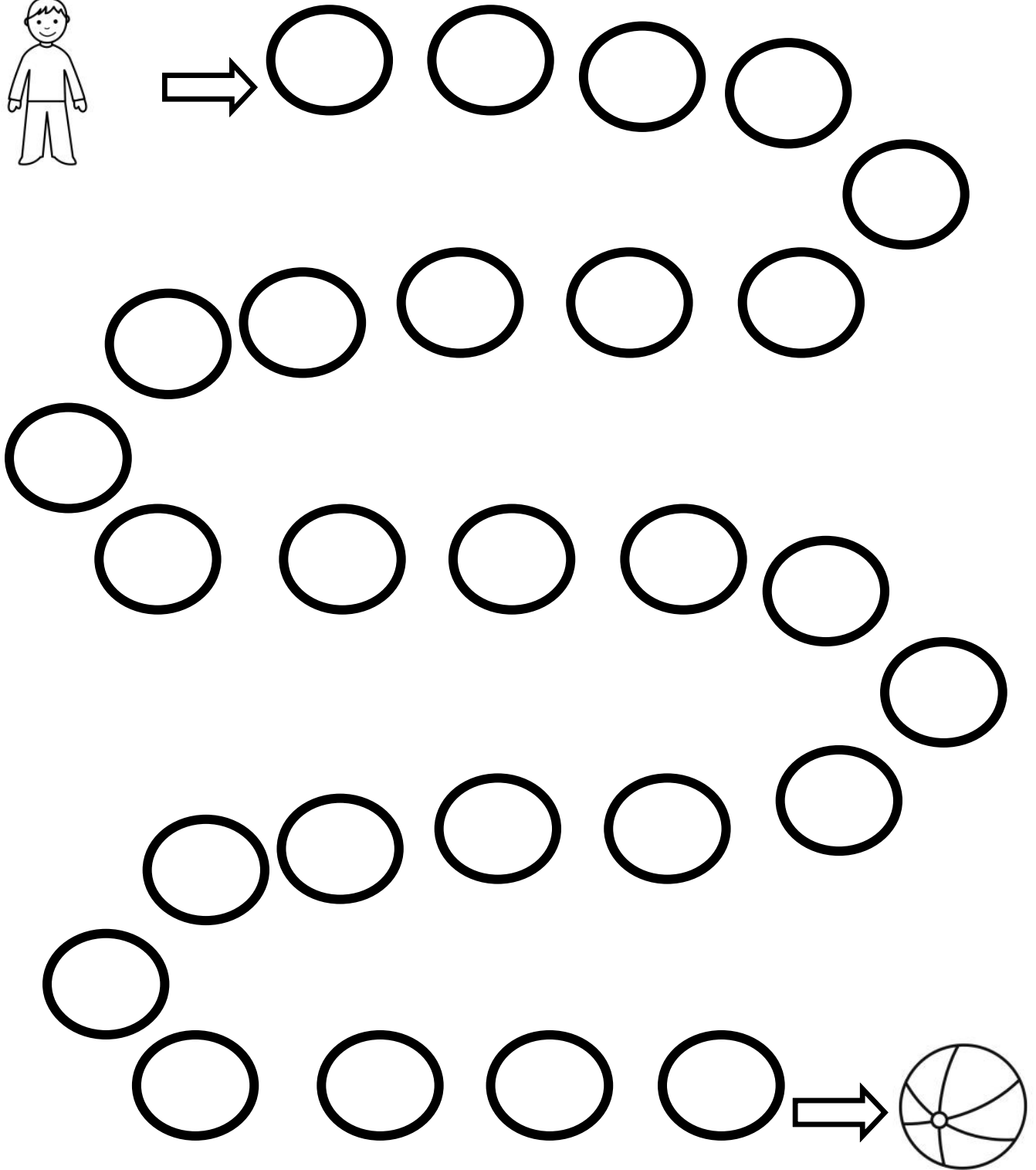
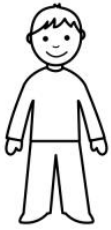

Actividades para mejorar motricidad fina

Sigue los círculos para unir al niño con la pelota

